



BENELUX
surgical

THE COMPANY

Benelux Surgical is a company working for approximately 15 years in manufacturing of specialized laryngoscopes. The company works with local and international customers in trading and has a good reputation based on the quality of work and procedures defined in all manufacturing. Company owns its own manufacturing units in which approximately 70_80 employees are working and performing very well. Company owns seven production engineers having their own team of development and manufacturing laryngoscope blades categories including

- Mac conv/interchangeable f.o/ fix tube f.o.MegaRay
- Miller conv/interchangeable f.o/fix tube
- Flexi tip mac conv/interchangeable/fix tube/megaray
- Disposable.mac.mill silver & plastic heel

MANUFACTURING CAPACITY

Company has a capacity of manufacturing 45000 single use blades of any kind related to laryngoscope and can manufacture 15000 reusable blades as per the demand of the customer.

MINIMUM ORDER PLACEMENT REQUIREMENTS

Company can facilitate the customers for any sample required on demand in case of availability of courier/cargo facility from customer side free of cost. The minimum order quantity that company can arrange items is 3000. However, there are some special cases in which company can place orders even less than the minimum specified quantity.

QUALITY PRODUCT

The company's main objective is to provide quality product to its customers. In this regard, company adheres with the quality procedures defined by the quality professionals available in our quality manual. We have a small research and development unit in our company where we make possible amendments as per the customer's requirements like blade size, shape etc...

CERTIFICATIONS

The company is manufacturing its items using standard quality systems such as CE Mark, ISO 9001 and 13485 respectively. The employability of these standards tends to enhance the image of the company goods in national and international market.

DELIVERY PLANS

Company delivery plans are totally dependent upon the customer's requirements but at the same time, company always liked to provide information of customers' orders tracking. In this regard, company provides bi-weekly order processing and tracking detail to customer as per customer's demand. Company adheres with the delivery plans no matter whatever are the circumstances and company keeps the customer notifying about their order details.

PAYMENT PLANS

Benelux surgical provides facility to customers to pay only 50% advance payment of their total order. The rest of the payment can be paid after the shipment delivery. Payment mode can be any depending upon the customer's choice like western union, direct bank account payment to the company account or any other secure method that is required by the customer.

PRODUCT DETAILS

Benelux Surgical is specialized in production of laryngoscope. Apart from it ,The Company Can also deal with quality production of variety of surgical and dental instruments. Sufficient information in terms of production detail is available in our catalog.

LOCATION

The manufacturing facility of the company is situated in World's largest Medical instruments producing city "SIALKOT". Sialkot is an industrial city of Pakistan, known globally for its skilled workmanship. The hand-made instruments produced in Sialkot are perceived to be of highest quality in the world.

The history of adroitness and dexterity starts from more than 100 years back. With the passage of time, Sialkot is now using modern facilities blended with indigenous craftsmanship.

Benelux surgical is at advantage being situated at Sialkot. We utilize all the human skills and God-gifted craftsmanship of the area.

HUMAN RESOURCE DEVELOPMENT

Benelux surgical believes that our people are our most valuable asset. Entire organization is provided professional support to ensure that business goals are realized through the craftsmanship of the people whose own personal aspirations are also met.

We try to ensure that highly motivated and professionally competent people are available within the organization. By adopting progressive personnel policies and providing competitive emoluments and perquisites, we try to maintain company's position as a preferred employer in the job market.

Training and Development of workers is considered to be a core value at Benelux surgical. This is an essential responsibility of every Manager. The Company has designated competent professionals who remains assessing the training needs.

Benelux surgical people are vital to the profitability of the Company and who directly contribute to the success of the organization. Benelux surgical Human Resource Program strives to ensure that a professional and caring environment continues to be fostered so that the creative energies of staff are fully utilized, while developing their potential.

EQUAL OPPORTUNITY EMPLOYER

Benelux surgical is equal opportunity employer and does not discriminate on the basis of religion, sect, race, sex or ethnicity. All recruitment is made strictly on merit that is determined on the basis of capability and capacity to perform tasks required by a particular job. Therefore the company has recruited diverse workforce and by successfully managing the diversity, the company enjoys positive synergy. Besides recruitment, Benelux surgical provides equal opportunities of growth and advancement in the company.

WORK PLACE PRACTICES

The company provides congenial work environment to its employees. The company maintain employee-friendly atmosphere. Self respect and self esteem of the employees is looked after.

Management of the company always encourages feedback and suggestions from all departments and at each level. Constructive suggestions are welcomed and appreciated. The company believes that free interaction and direct communication will help management to understand production and personnel problems in a better way.

The company complies with the rules and regulations promulgated by the government in respect of working hours, holidays, lunch break, compensation and social benefits. If labour is assigned work in excess of normal working hours, they are rewarded with justified over time as per the provisions of the law.

The company contributes to Old AGE Benefit Intuition for its labour to provide them social security in old age.

COMPLIANCE WITH LAW

The company fully comply all legal requirements and its compliance is verified by Statutory Auditors.

SOCIAL COMPLIANCE PROGRAMME

CHILD LABOUR ELIMINATION PROGRAMME

Benelux surgical strongly realize that Child labour is a social menace. It has been confronting states and societies in under-developed and developing parts of the world. Being, responsible corporate citizen, Benelux surgical believes, this social evil must be discouraged and eliminated from the society. Benelux surgical has been fighting against this social evil since its creation.

TABLE OF CONTENTS







| | | | |
|------------------|--------------------------|----------------|---|
| SECTION A | Scalpels | Page 01 - 09 |  |
| SECTION B | Scissors | Page 10 - 58 |  |
| SECTION C | Forceps | Page 59 - 73 |  |
| SECTION D | Artery Forceps | Page 74 - 114 |  |
| SECTION E | Cotton Swab Forceps etc. | Page 115 - 123 |  |
| SECTION F | Retractors | Page 124 - 180 |  |

TABLE OF CONTENTS

**SECTION
G**

Probes

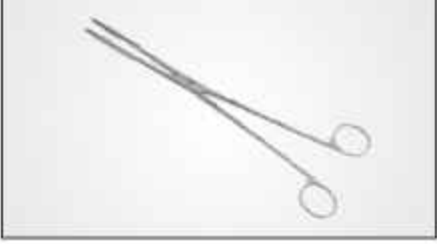
Page 181 - 185



**SECTION
H**

Suction Tubes

Page 186 - 196



**SECTION
I**

Needle Holders

Page 197 - 223





BENELUX
s u r g i c a l

Page 01-09

SECTION

A

- Dissecting Knives
- Autopsy, Cartilage, Post Mortem & Brain Knives
- Razor Blade Holders & Breakers
- Scalpel Handle
- Scalpels, Tenotomes
- Amputating Knives, Autopsy Knives
- Scalpels, Tenotomes & Resection Knives
- Dermatomes



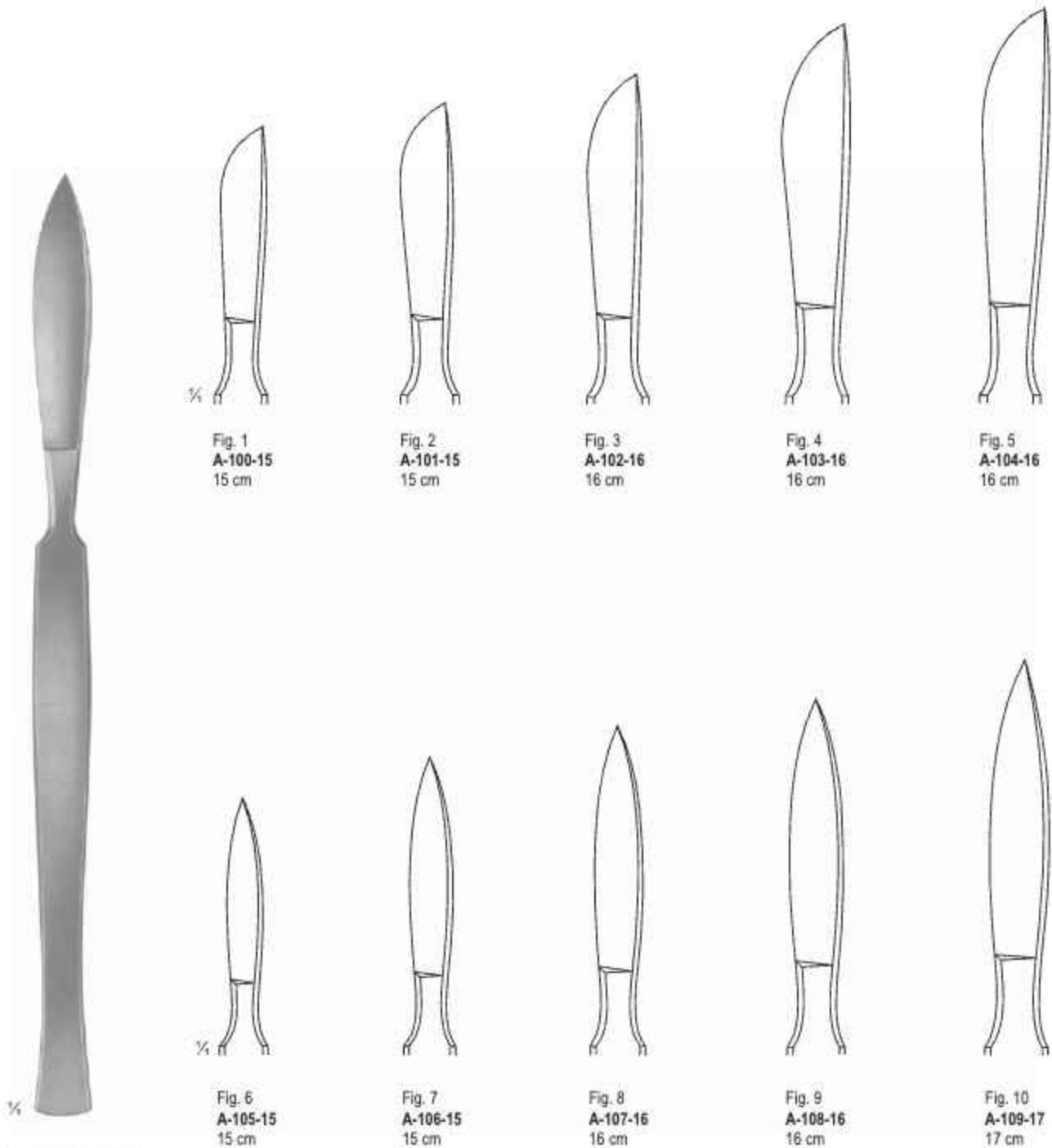

DISSECTING KNIVES
Fig. 1 - 10
A-100-15 - A -109-17

**SECTION
A**

Autopsy, Cartilage, Post Mortem & Brain Knives



**BENELUX
surgical**



A-110-25
25.5 cm



**VIRCHOW
A-111-04**



**VIRCHOW
A-112-26 - A-114-38**

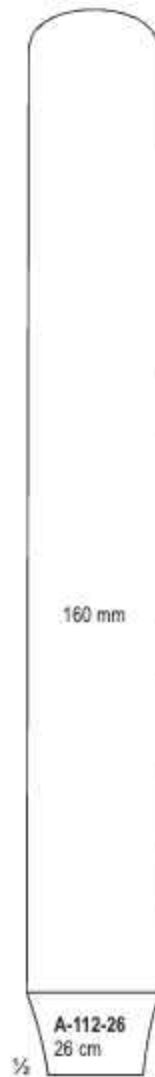

A-112-26
160 mm
26 cm
1/8

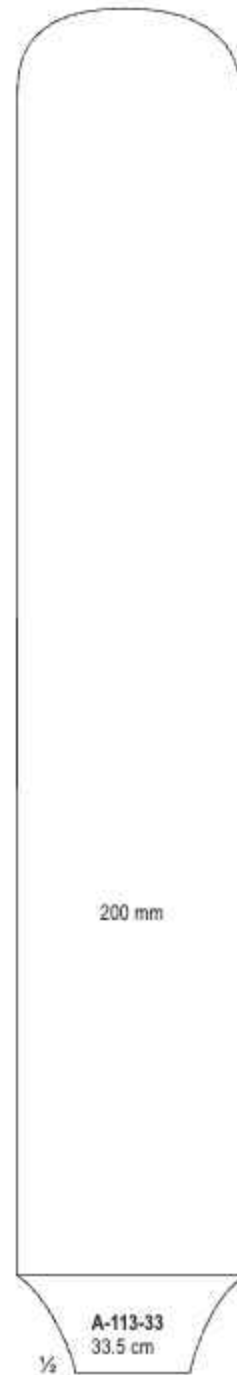

A-113-33
200 mm
33.5 cm
1/8

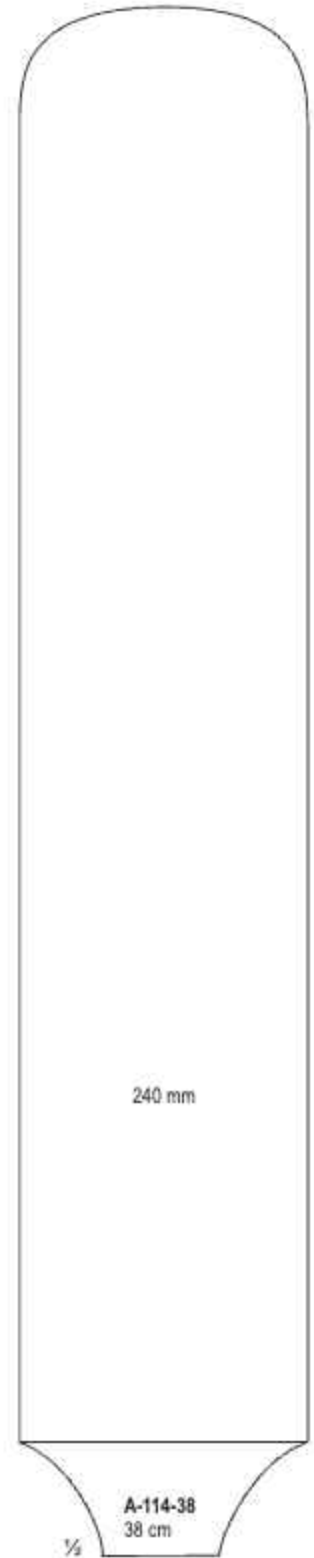

A-114-38
240 mm
38 cm
1/8



TROUTMAN-CHRIS
A-115-09
9 cm



TROUTMAN-CHRIS
A-116-09
9 cm



A-117-11
11 cm



CASTROVIEJO
A-118-13
13 cm



A-119-18
18.5 cm

**SECTION
A**

SCALPEL HANDLE

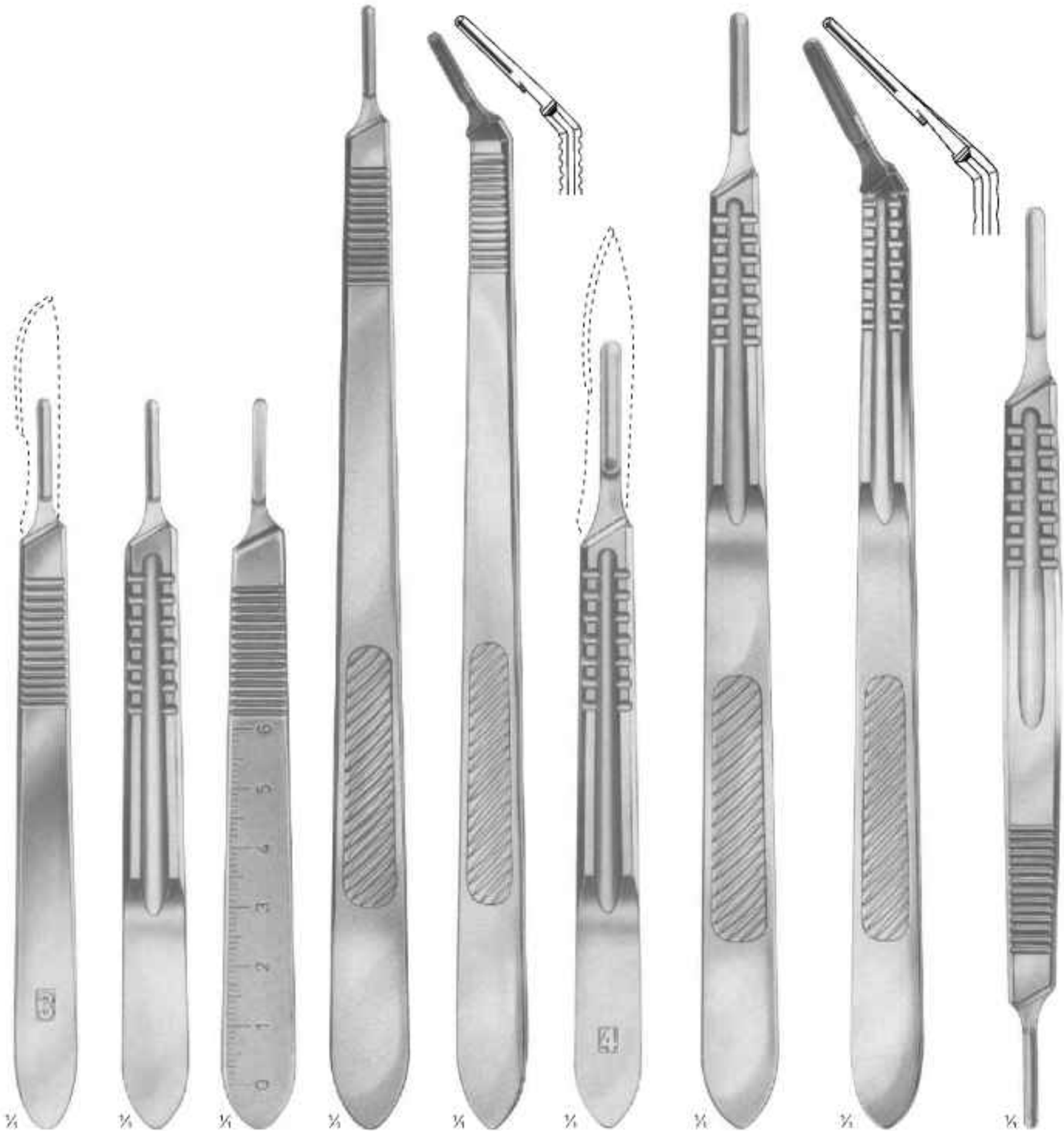

STANDARD
A-120-03
No. 3
Solid

A-121-03
No. 3
Solid

A-122-03
No. 3
Solid

A-123-03
No. 3 L
Straight
Solid

A-124-03
No. 3 L
Angled
Solid

STANDARD
A-125-04
No. 4
Solid

A-126-04
No. 4 L
Straight
Solid

01-127-04
No. 4 L
Solid Angled

A-128-04
Double Handle
No. 4 + No. 3
Solid



A-129-16
No. 7
Solid
16 cm



A-130-12
No. 7 K
Solid
12.5 cm



A-131-15
Hollow-Round
15.5 cm



A-132-14
No. 3
Straight
Solid
14 cm



A-133-03
No. 3
Angled
Solid



COLLIN
A-134-08
No. 8
Hollow



COLLIN
A-135-09
No. 9
Hollow

SECTION
A

SCALPELS, TENOTOMES

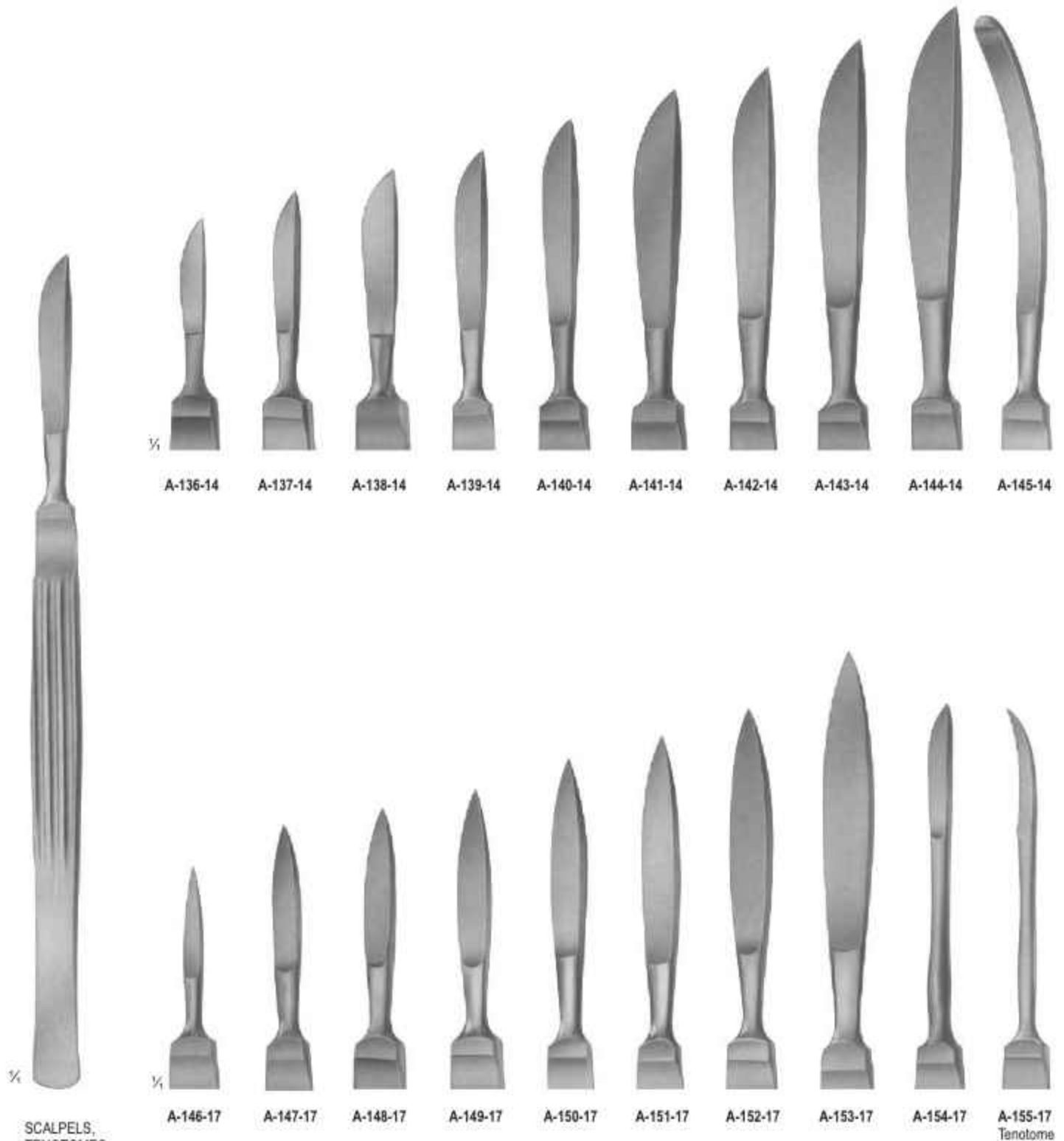

1/4

A-136-14

A-137-14

A-138-14

A-139-14

A-140-14

A-141-14

A-142-14

A-143-14

A-144-14

A-145-14

1/4

1/4

A-146-17

A-147-17

A-148-17

A-149-17

A-150-17

A-151-17

A-152-17

A-153-17

A-154-17

A-155-17
Tenotome

SCALPELS,
TENOTOMES
A-136-14 - A-155-17
14 cm - 17.5 cm



LISTON
A-156-29 - A-157-32
A-156-29 29 cm
A-157-32 32 cm



CATLIN
A-158-11 - A-159-16
A-158-11 11 cm
A-159-16 16 cm
Blade Length
Amputating
Knives



COLLIN
A-160-13 - A-163-20
A-160-13 13 cm
A-161-16 16 cm
A-162-19 19 cm
A-163-20 20 cm
Blade Length
Amputating Knives



LANGENBECK
A-164-12 - A-165-18
A-164-12 12 cm
A-165-18 18 cm
Blade Length
Flap Knives



LANGENBECK
A-166-18
18 cm



LANGENBECK
A-167-18
18 cm

SECTION
A

SCALPELS, TENOTOMES & RESECTION KNIVES



BENELUX
surgical

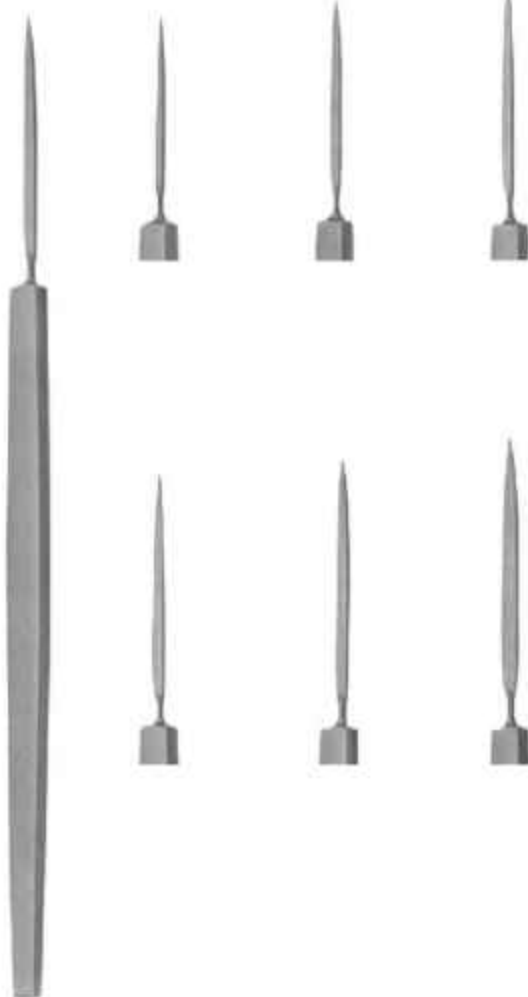

GRAEFE
A-168-00 - A-173-00
13 cm



DIEFFENBACH
A-174-00 - A-175-00
16 cm



0
10



A-176-08
8 cm
Blade Length
Metal Handle



A-177-19
19.5 cm
Blade Length
Metal Handle



1/2

HUMBY
A-178-32
32 cm



HUMBY
A-178-32



1/2

SCHINK
A-179-30
30 cm



SCHINK
A-179-30



SILVER
A-180-19
19.5 cm



BENELUX
s u r g i c a l

Page 10-58

SECTION

B

- Surgical Scissors
- Delicate Scissors
- Dissecting Scissors
- Operating And Gynecology Scissors
- Vessel Scissors
- Delicate, Nasal And Tonsil Scissors
- Ligature Scissors
- Wire And Plate Scissors
- Bowel Scissors, Cartilage Scissors



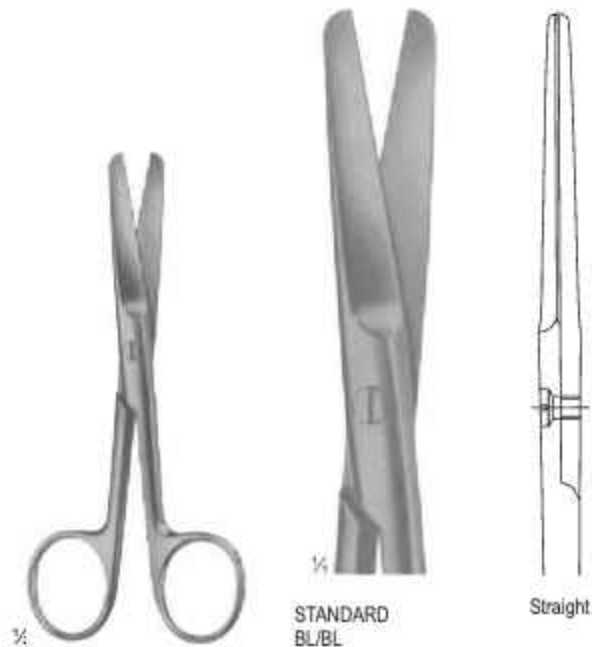

STANDARD
BL/BL
B-100-10 - B-106-20
B-100-10 10.5 cm
B-101-11 11.5 cm
B-1B-13 13 cm
B-103-14 14.5 cm
B-104-16 16.5 cm
B-105-18 18.5 cm
B-106-20 20 cm



STANDARD
BL/BL
B-107-10 - B-113-20
B-107-10 10.5 cm
B-108-11 11.5 cm
B-109-13 13 cm
B-110-14 14.5 cm
B-111-16 16.5 cm
B-112-18 18.5 cm
B-113-20 20 cm

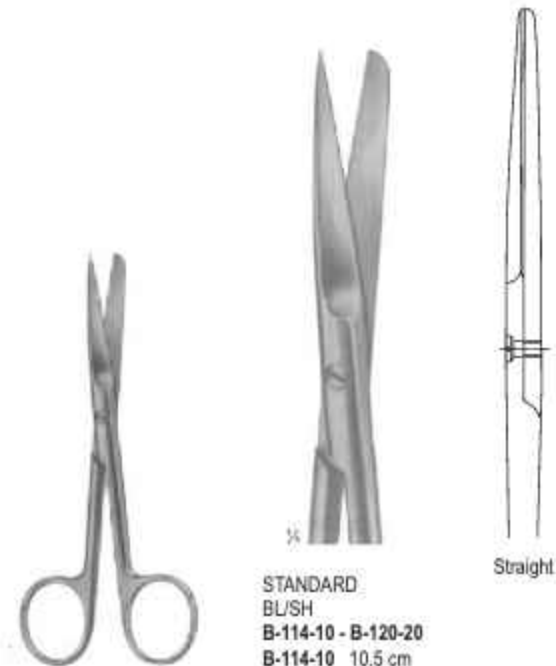

STANDARD
BL/SH
B-114-10 - B-120-20
B-114-10 10.5 cm
B-115-11 11.5 cm
B-116-13 13 cm
B-117-14 14.5 cm
B-118-16 16.5 cm
B-119-18 18.5 cm
B-120-20 20 cm

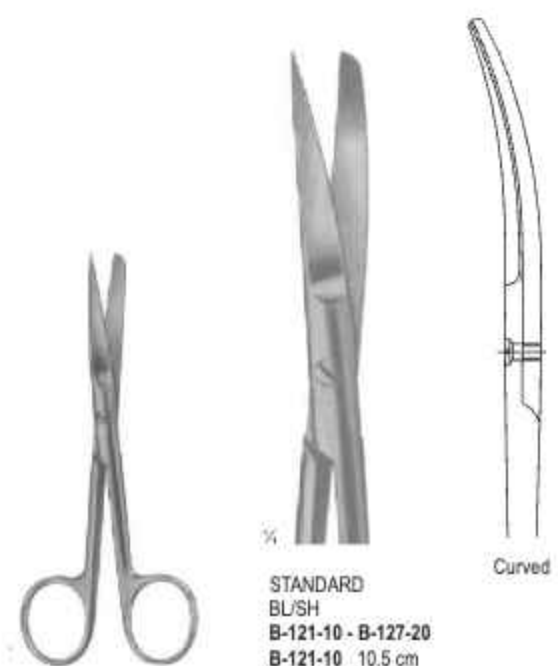

STANDARD
BL/SH
B-121-10 - B-127-20
B-121-10 10.5 cm
B-122-11 11.5 cm
B-123-13 13 cm
B-124-14 14.5 cm
B-125-16 16.5 cm
B-126-18 18.5 cm
B-127-20 20 cm

**SECTION
B**

Surgical Scissors



Straight

**STANDARD
SH/SH**
B-128-10 - B-134-20
B-128-10 10.5 cm
B-129-11 11.5 cm
B-130-13 13 cm
B-131-14 14.5 cm
B-132-16 16.5 cm
B-133-18 18.5 cm
B-134-20 20 cm



Curved

B-135-10 - B-141-20
B-135-10 10.5 cm
B-136-11 11.5 cm
B-137-13 13 cm
B-138-14 14.5 cm
B-139-16 16.5 cm
B-140-18 18.5 cm
B-141-20 20 cm

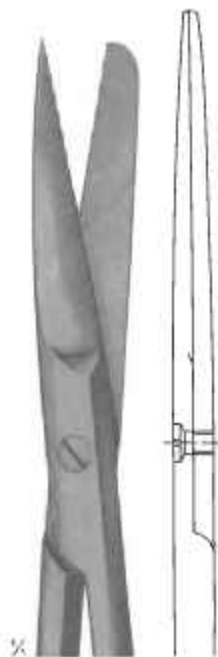

B-142-14
SH/BL
 straight
 14.5 cm

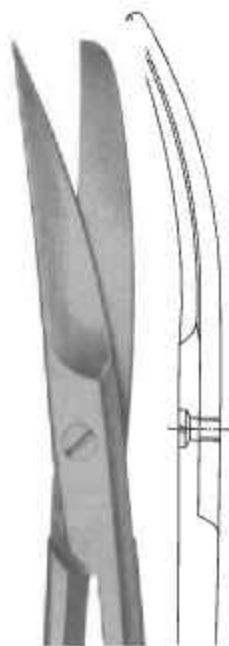

B-143-14
SH/BL
 curved
 14.5 cm



Straight

INCISION SCISSORS
B-144-13 - B-146-16
B-144-13 13 cm
B-145-14 14.5 cm
B-146-16 16.5 cm

DEAVER
B-142-14 - B-143-14

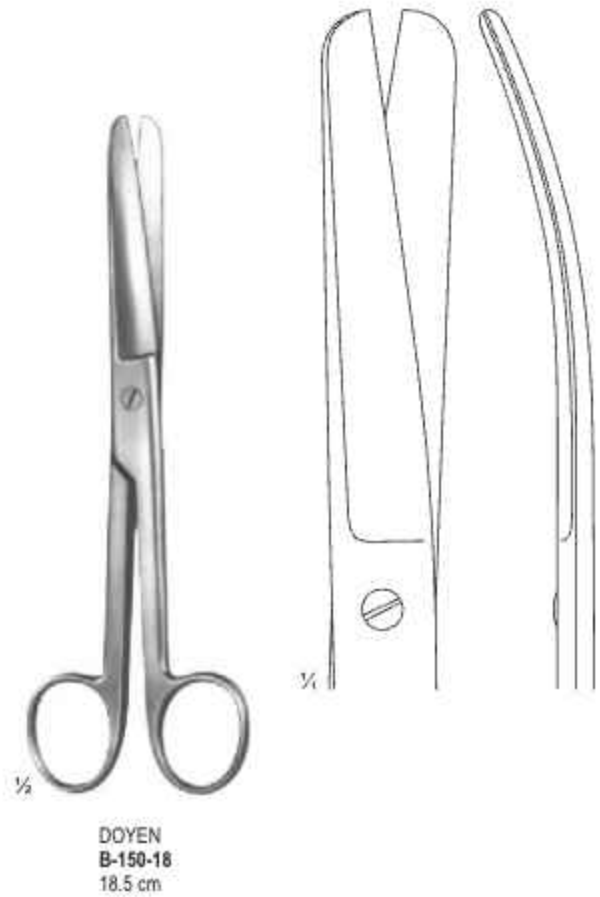
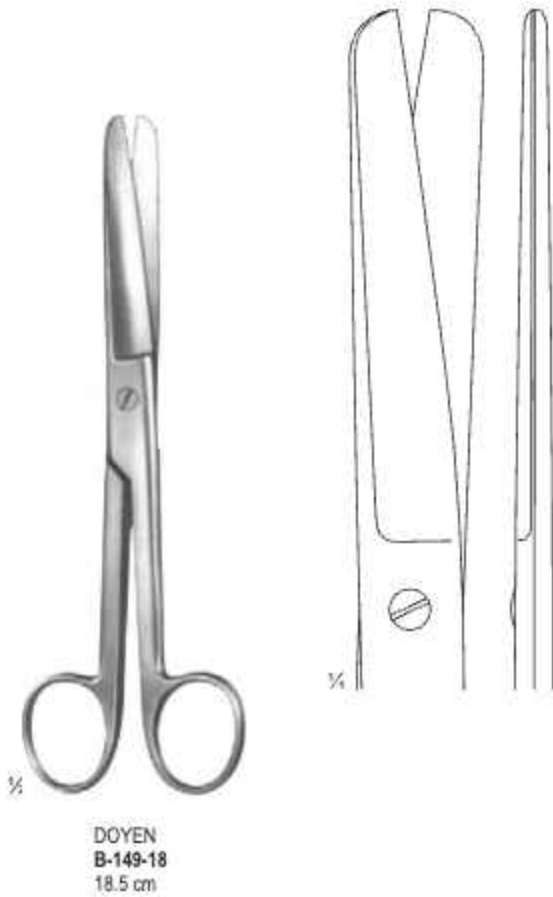
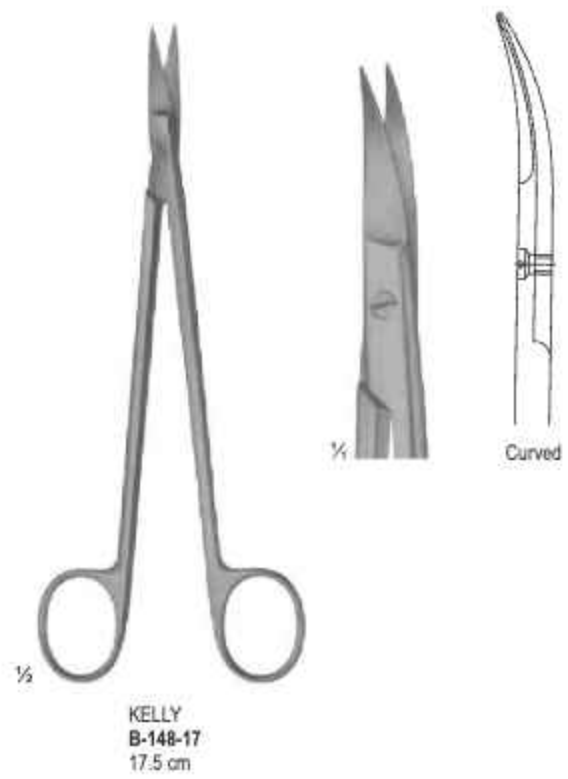

**SECTION
B**

Dissecting Scissors

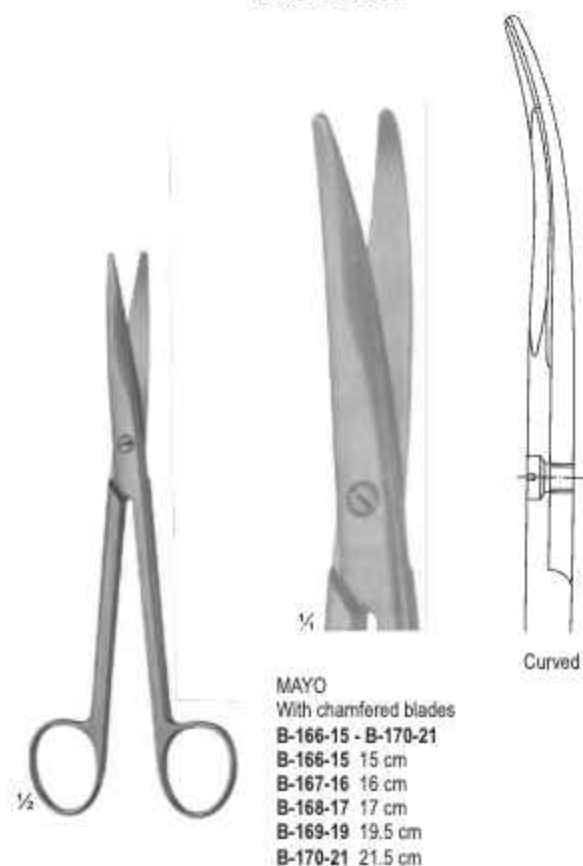
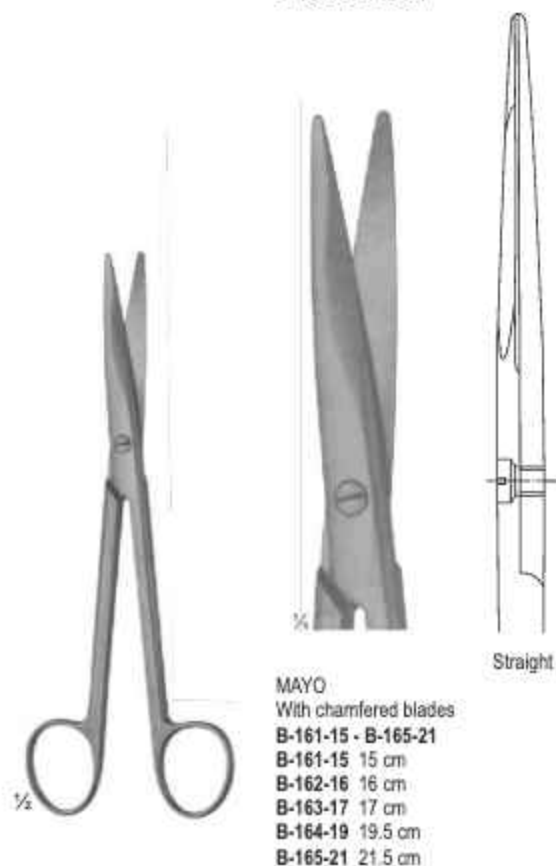
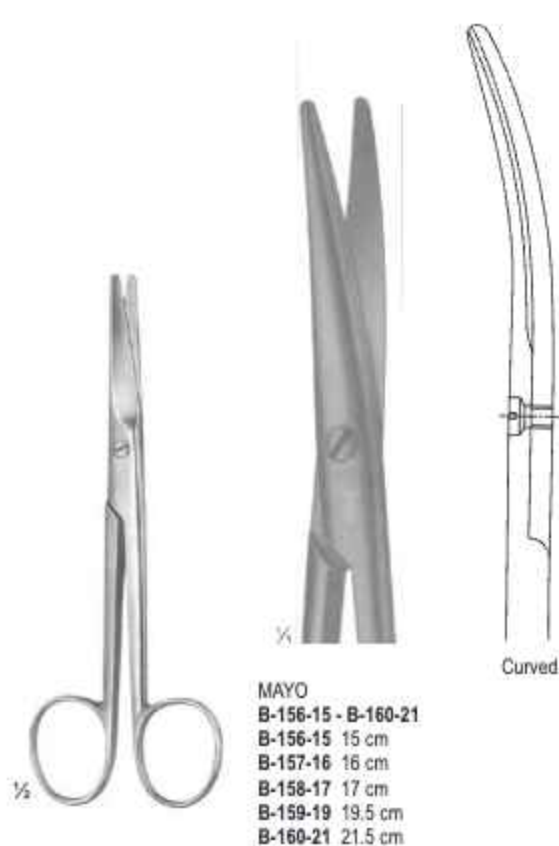
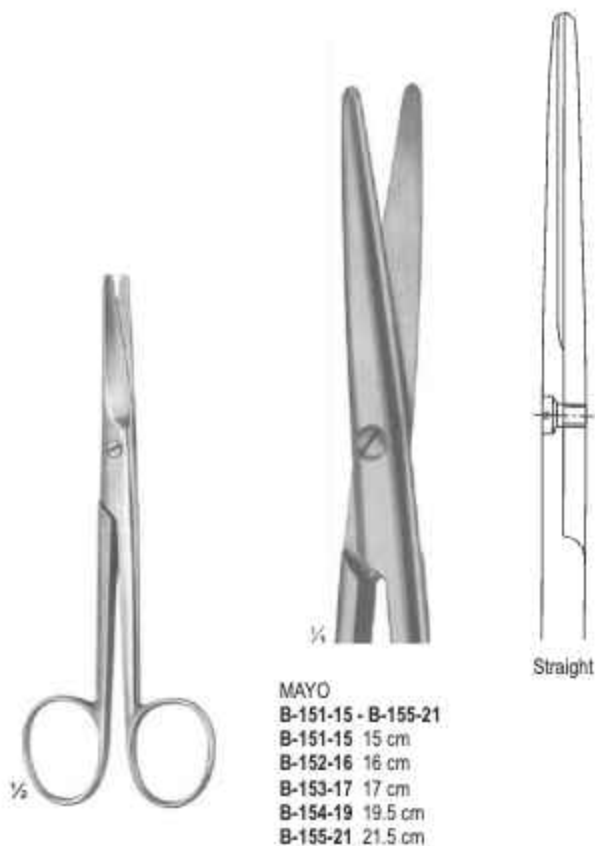

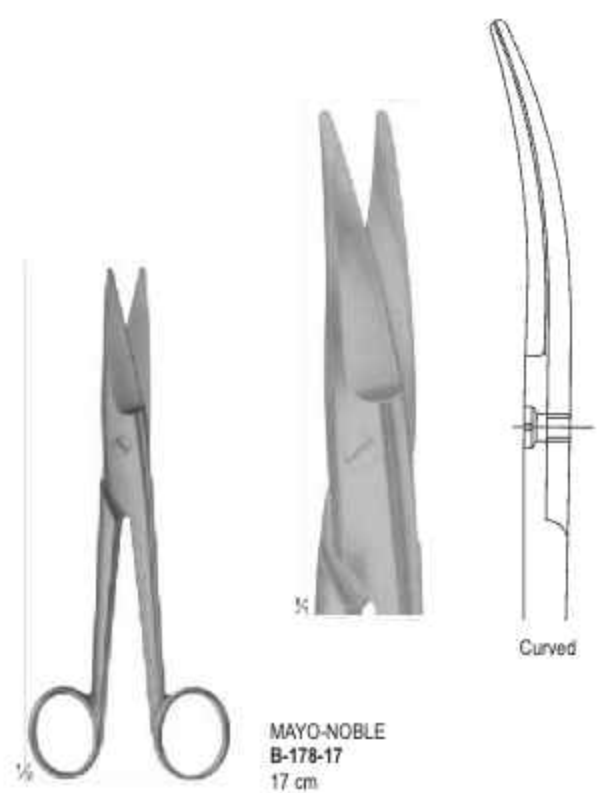
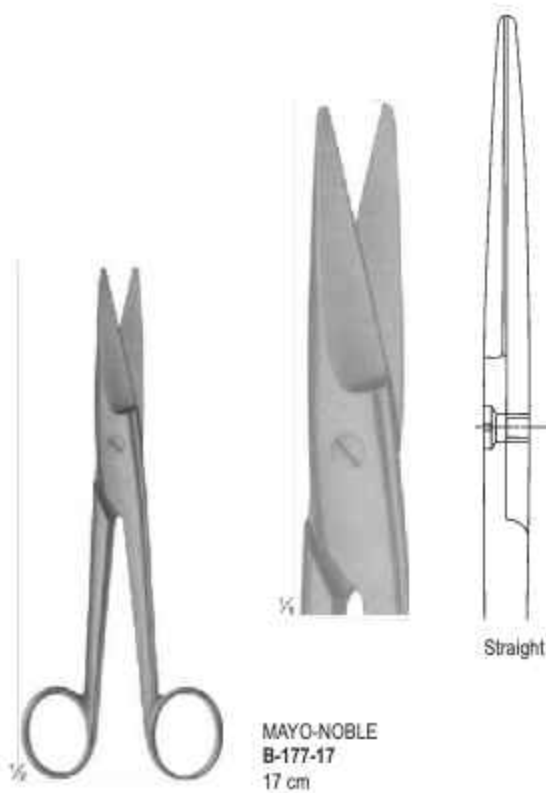
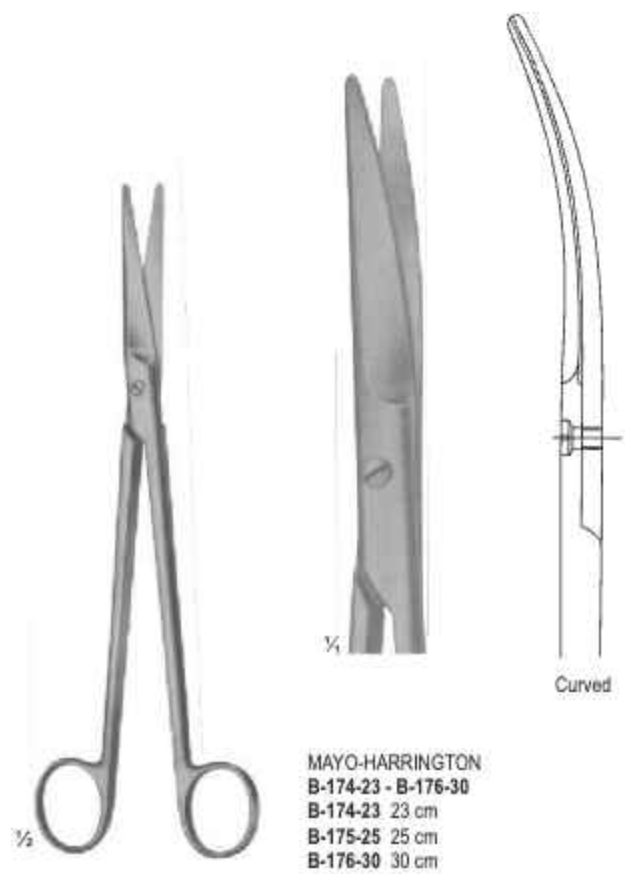
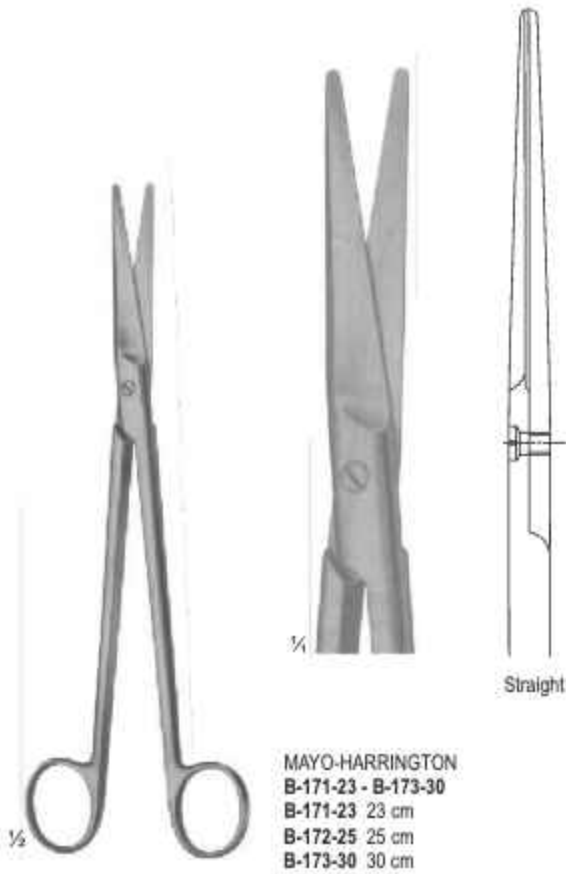

**SECTION
B**

Dissecting Scissors

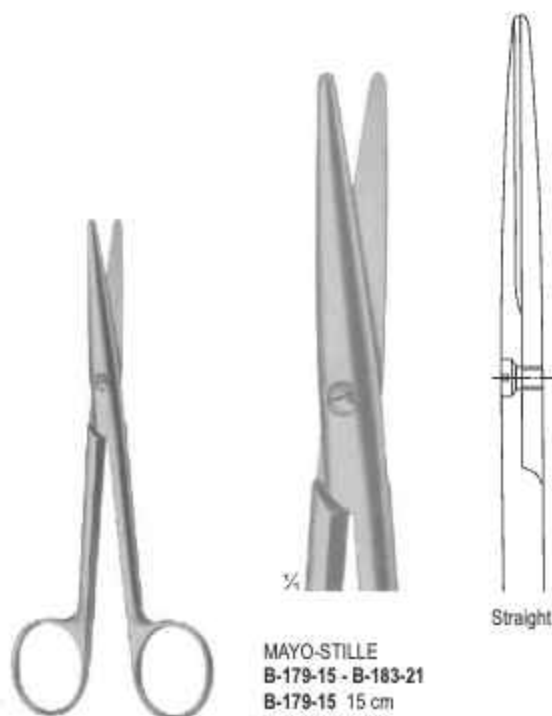

MAYO-STILLE
B-179-15 - B-183-21
 B-179-15 15 cm
 B-180-16 16 cm
 B-181-17 17 cm
 B-182-19 19.5 cm
 B-183-21 21.5 cm

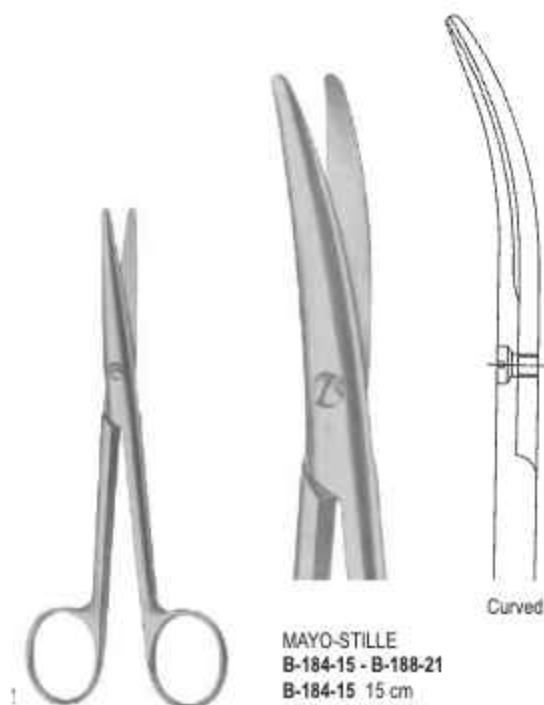

MAYO-STILLE
B-184-15 - B-188-21
 B-184-15 15 cm
 B-185-16 16 cm
 B-186-17 17 cm
 B-187-19 19.5 cm
 B-188-21 21.5 cm

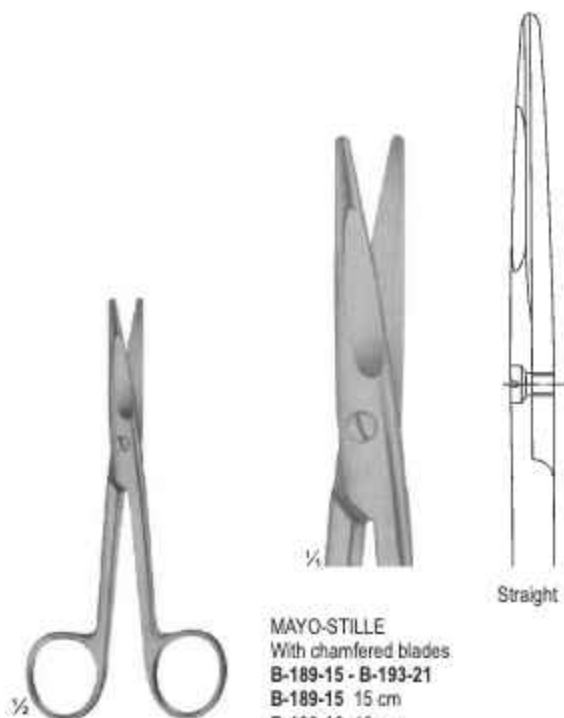

MAYO-STILLE
 With chamfered blades
B-189-15 - B-193-21
 B-189-15 15 cm
 B-190-16 16 cm
 B-191-17 17 cm
 B-192-19 19.5 cm
 B-193-21 21.5 cm

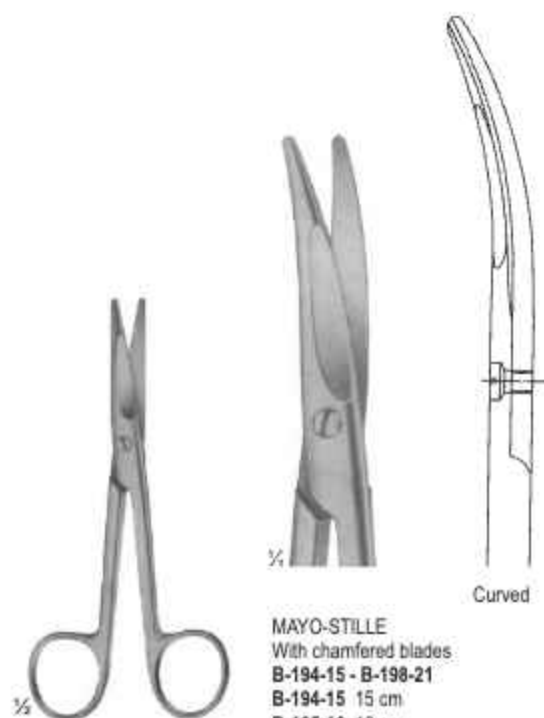

MAYO-STILLE
 With chamfered blades
B-194-15 - B-198-21
 B-194-15 15 cm
 B-195-16 16 cm
 B-196-17 17 cm
 B-197-19 19.5 cm
 B-198-21 21.5 cm



Straight

SIMS
B-199-20 - B-200-23
B-199-20 20 cm
B-200-23 23 cm

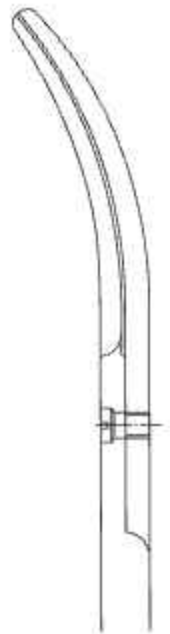

Curved

SIMS
B-201-20 - B-203-23
B-201-20 20 cm
B-203-23 23 cm



Straight

SIMS
B-204-20 - B-205-23
B-204-20 20 cm
B-205-23 23 cm

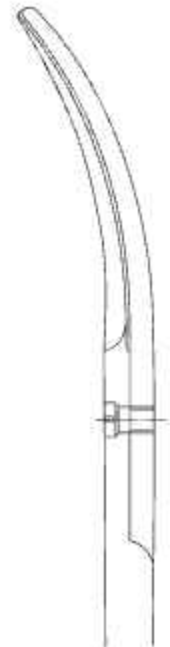

Curved

SIMS
B-206-20 - B-208-23
B-206-20 20 cm
B-207-21 21 cm
B-208-23 23 cm

**SECTION
B**

Operating And Gynecology Scissors



SIMS
B-209-20 - B-211-23
B-209-20 20 cm
B-210-21 21 cm
B-211-23 23 cm



WERTHEIM
B-212-14 - B-214-23
B-212-14 14.5 cm
B-213-20 20 cm
B-214-23 23 cm





SIEBOLD
B-215-24
Uterine Scissors
24.5 cm

BOZEMANN
B-216-22
Uterine Scissors
22 cm

SIMS-SIEBOLD
B-217-25
Uterine Scissors
25 cm

**SECTION
B**

Dissecting Scissors

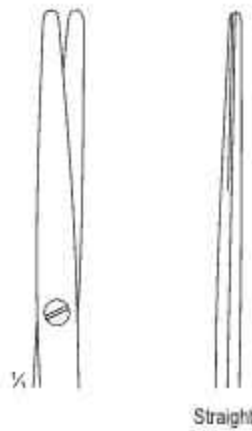

METZENBAUM
B-216-11 - B-226-30
B-218-11 11.5 cm (Baby)
B-219-14 14.5 cm
B-220-15 15.5 cm
B-221-18 18 cm
B-222-20 20 cm
B-223-23 23 cm
B-224-25 25 cm
B-225-28 28 cm
B-226-30 30 cm

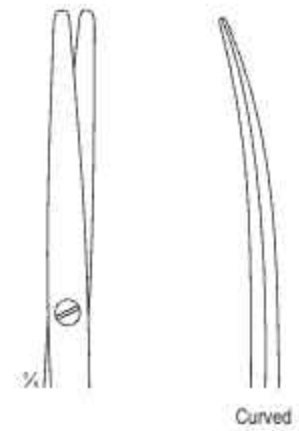

METZENBAUM
B-227-11 - B-235-30
B-227-11 11.5 cm (Baby)
B-228-14 14.5 cm
B-229-15 15.5 cm
B-230-18 18 cm
B-231-20 20 cm
B-232-23 23 cm
B-233-25 25 cm
B-234-28 28 cm
B-235-30 30 cm

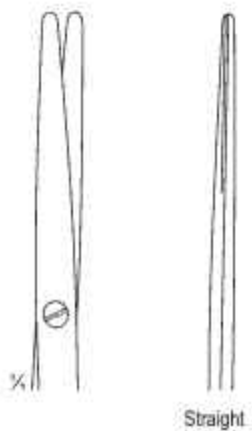

METZENBAUM-NELSON
B-236-18 - B-241-30
B-236-18 18 cm
B-237-20 20 cm
B-238-23 23 cm
B-239-26 26 cm
B-240-28 28 cm
B-241-30 30 cm

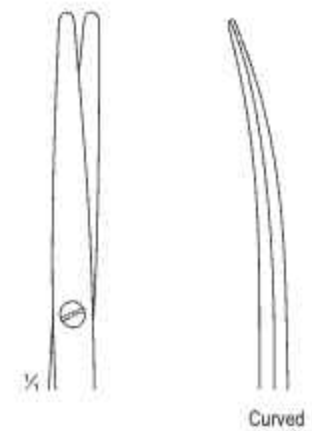

METZENBAUM-NELSON
B-242-18 - B-247-31
B-242-18 18 cm
B-243-20 20.5 cm
B-244-23 23 cm
B-245-26 26 cm
B-246-28 28.5 cm
B-247-31 31 cm



FINO-METZENBAUM
B-248-18 - B-253-30
B-248-18 18 cm
B-249-20 20 cm
B-250-23 23 cm
B-251-26 26 cm
B-252-28 28 cm
B-253-30 30 cm



FINO-METZENBAUM
B-254-18 - B-259-30
B-254-18 18 cm
B-255-20 20 cm
B-256-23 23 cm
B-257-26 26 cm
B-258-28 28 cm
B-259-30 30 cm

**SECTION
B**

Dissecting Scissors

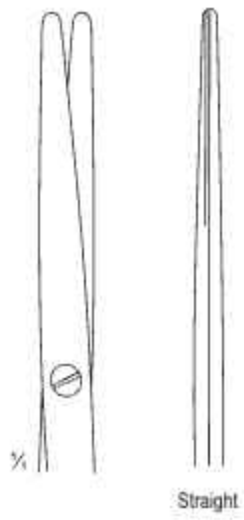

Straight

LEXER
B-260-10 - B-262-21
B-260-10 10 cm (Baby)
B-261-16 16 cm
B-262-21 21 cm

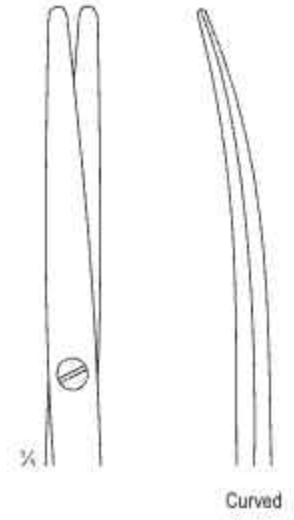

Curved

LEXER
B-263-10 - B-265-21
B-263-10 10 cm (Baby)
B-264-16 16 cm
B-265-21 21 cm



Straight

LEXER
B-266-10 - B-268-21
B-266-10 10 cm (Baby)
B-267-16 16 cm
B-268-21 21 cm



Curved

LEXER
B-269-10 - B-271-21
B-269-10 10 cm (Baby)
B-270-16 16 cm
B-271-21 21 cm

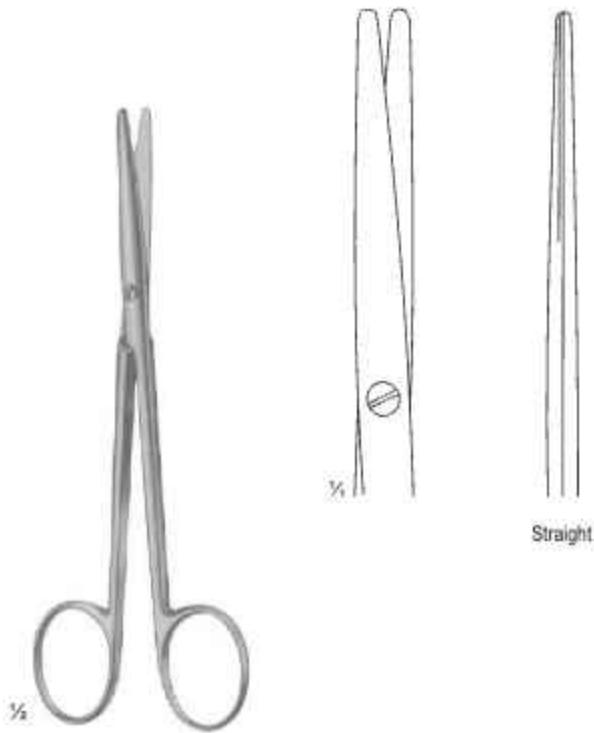

LEXER-FINO
B-272-16
16.5 cm

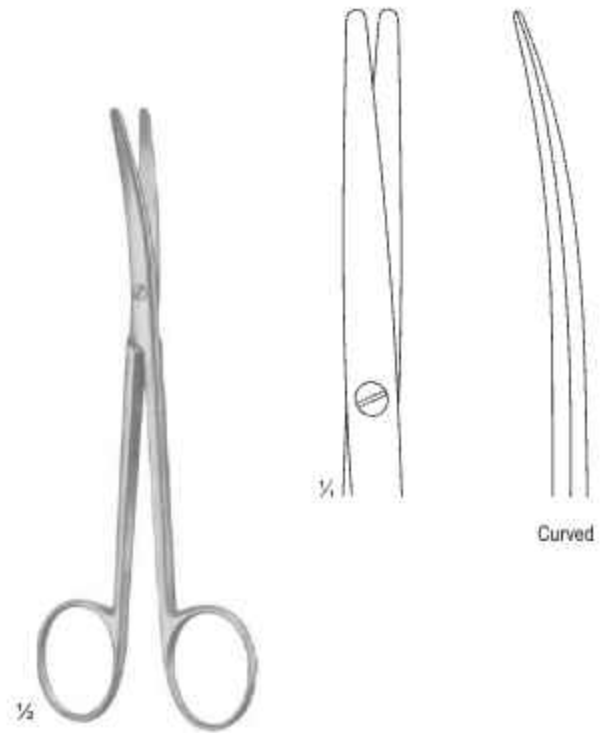

LEXER-FINO
B-273-16
16.5 cm

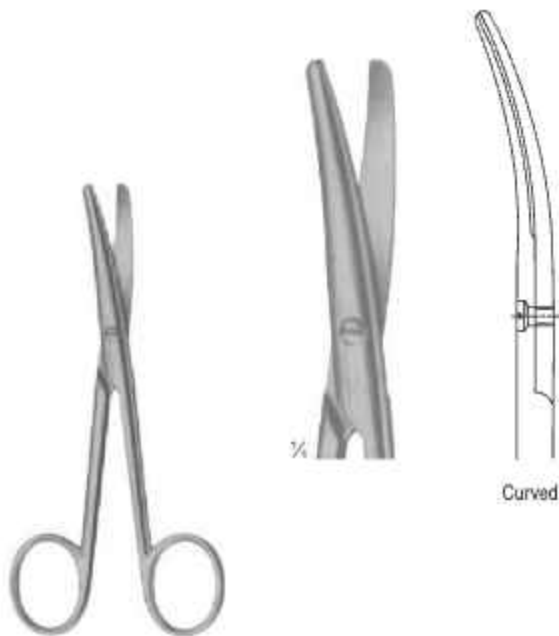

LANDOLT
Enucleation scissors
B-274-12
12 cm

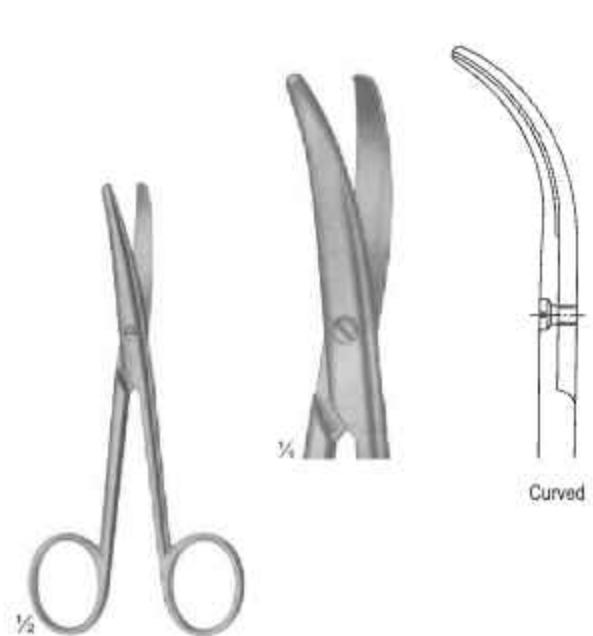

LANDOLT
Enucleation scissors
B-275-12
12 cm

**SECTION
B**

Delicate Scissors

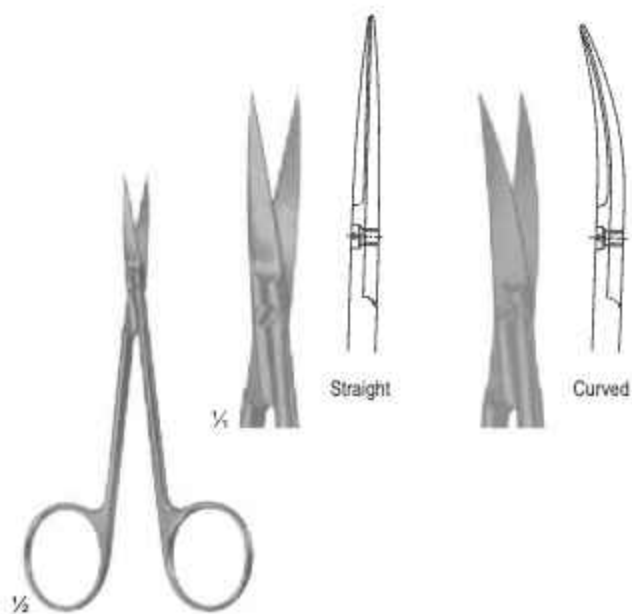

IRIS
B-276-09 - B-278-11
B-276-09 9 cm
B-277-10 10 cm
B-278-11 11.5 cm

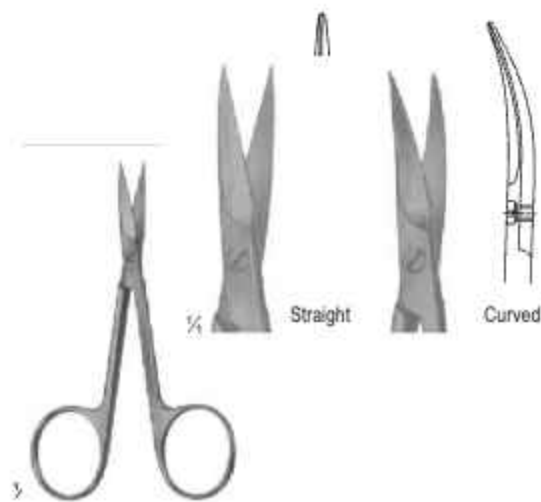

CUTICAL
B-279-09
 9 cm

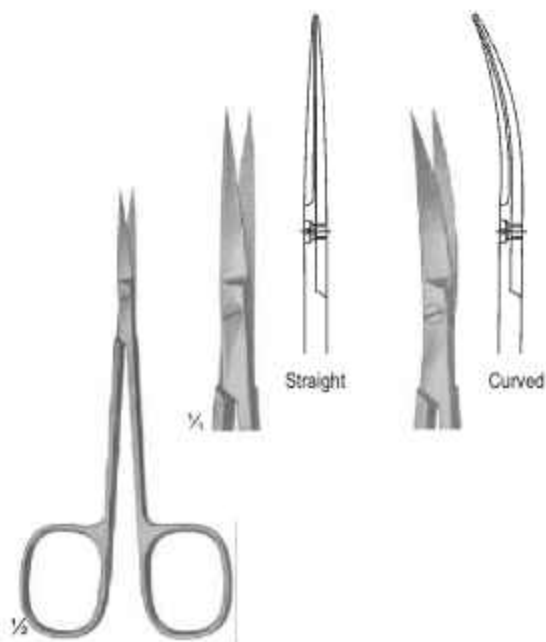

B-280-12
 12 cm

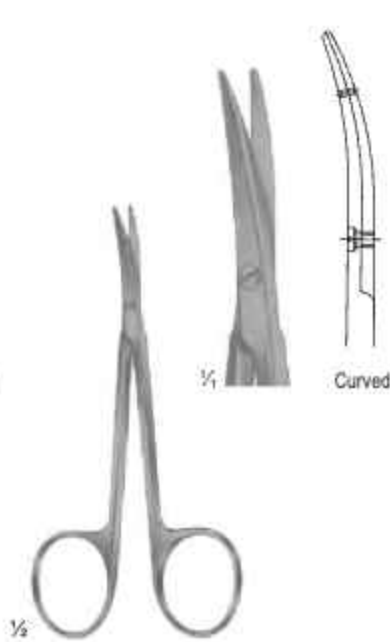

LITTLER
 Dissecting Scissors
 Tips with eye for suture
B-281-11
 11.5 cm

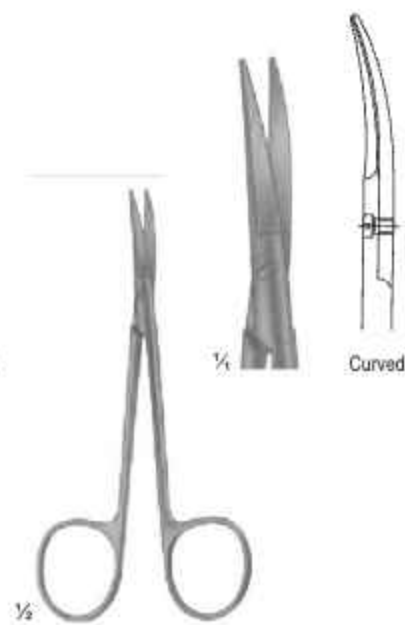

COTTLE
 Bulldog Scissors
B-282-11
 11.5 cm

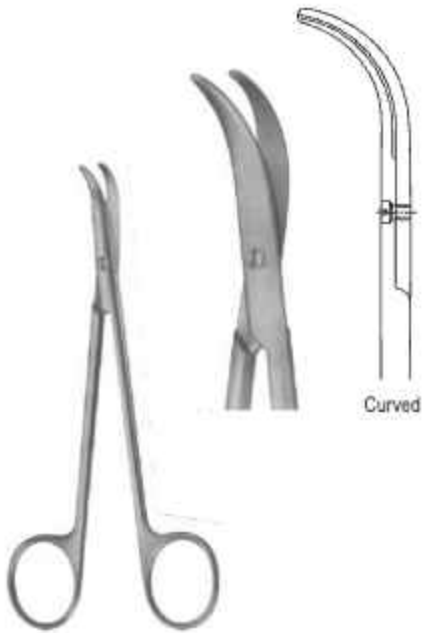

FOMON
B-283-11 - B-284-13
B-283-11 11.5 cm
B-284-13 13.5 cm
Lower lateral scissors.

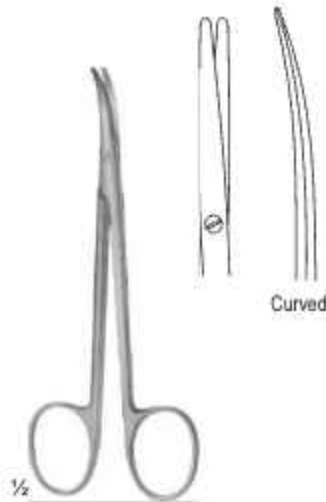

CINELLI
B-285-11
11.5 cm

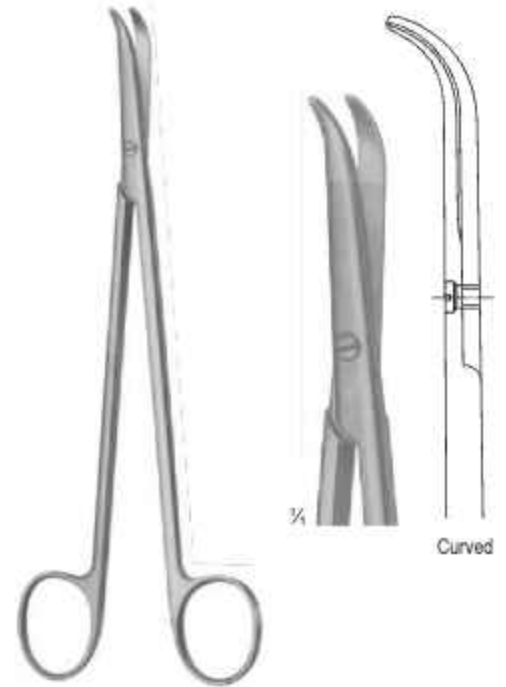

THOREK
B-286-18
18 cm

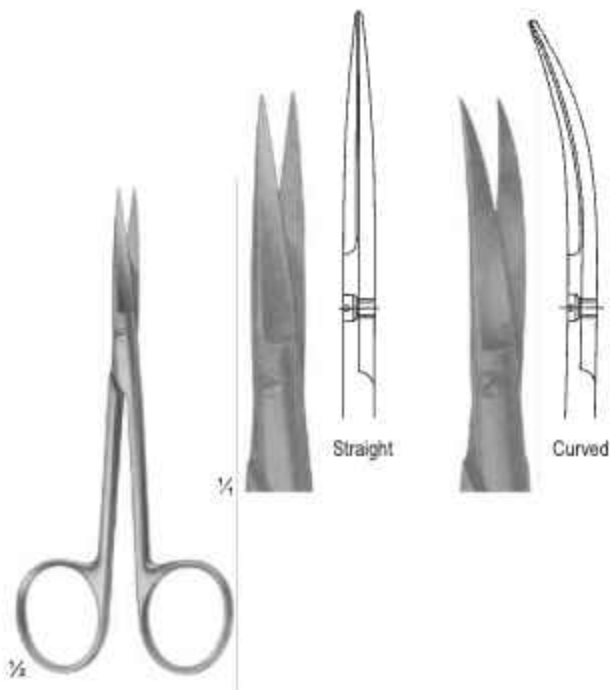

WAGNER
B-287-13
13 cm

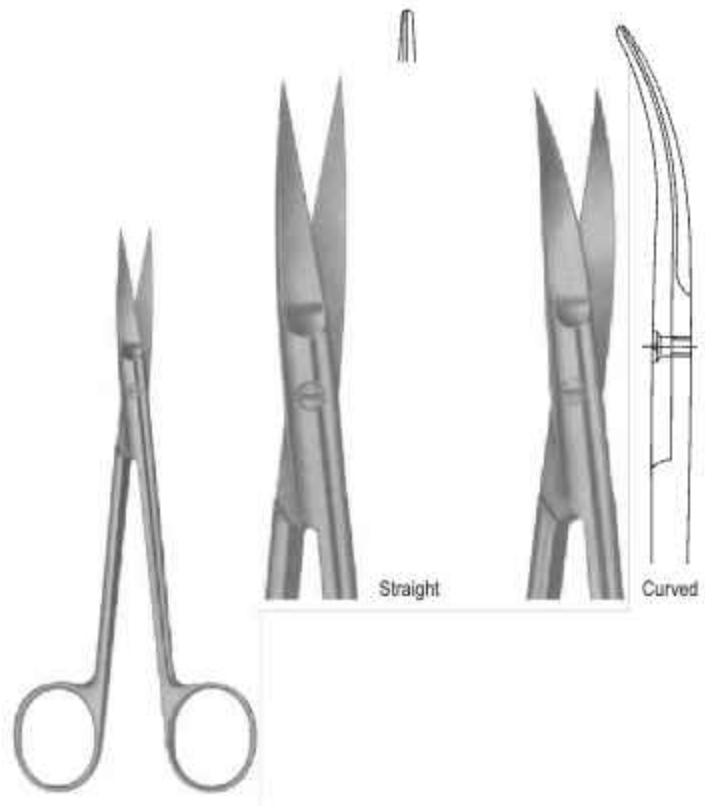

JOSEPH
B-288-15
15 cm

**SECTION
B**

Delicate Scissors



STEVENS
Dissecting Scissors
B-289-11
11.5 cm

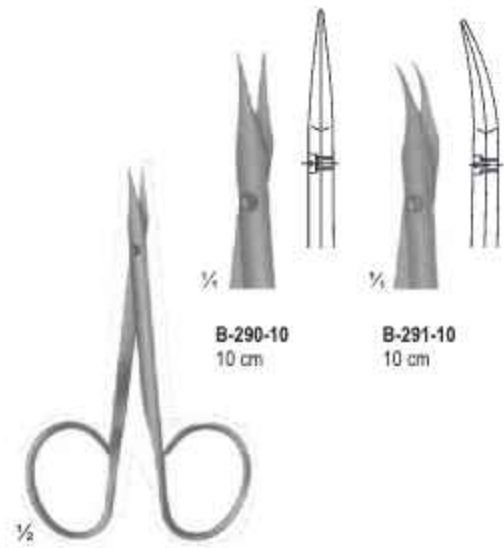
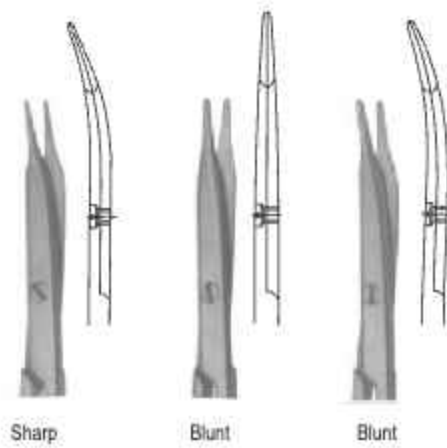

STEVENS
Vessel and tendon Scissors
B-290-10 - B-291-10



STEVENS
Fine Dissecting Scissors
B-292-11
11 cm

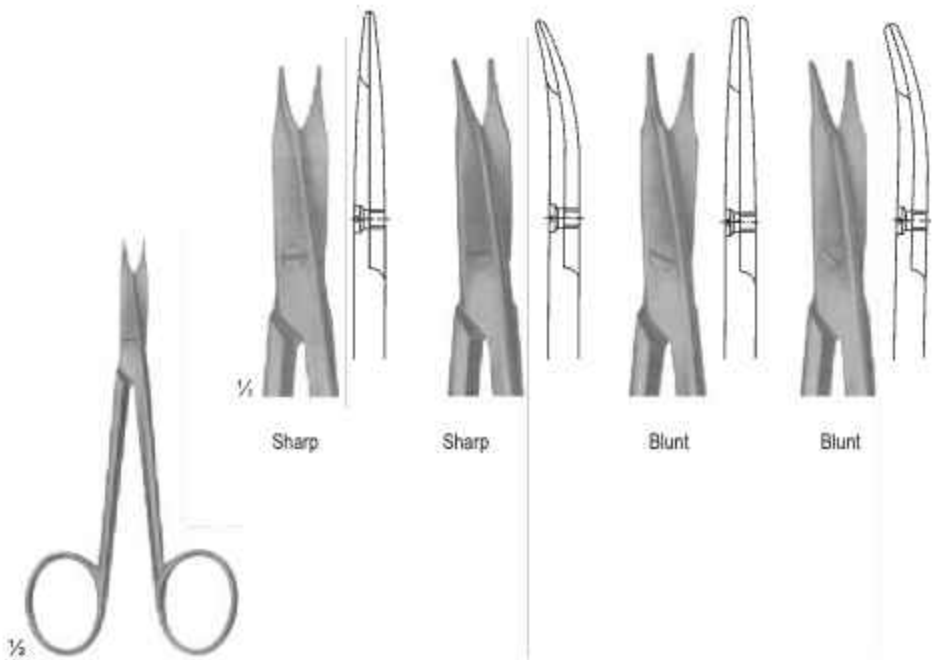

STEVENS
Vessel and tendon Scissors
B-293-11
11 cm

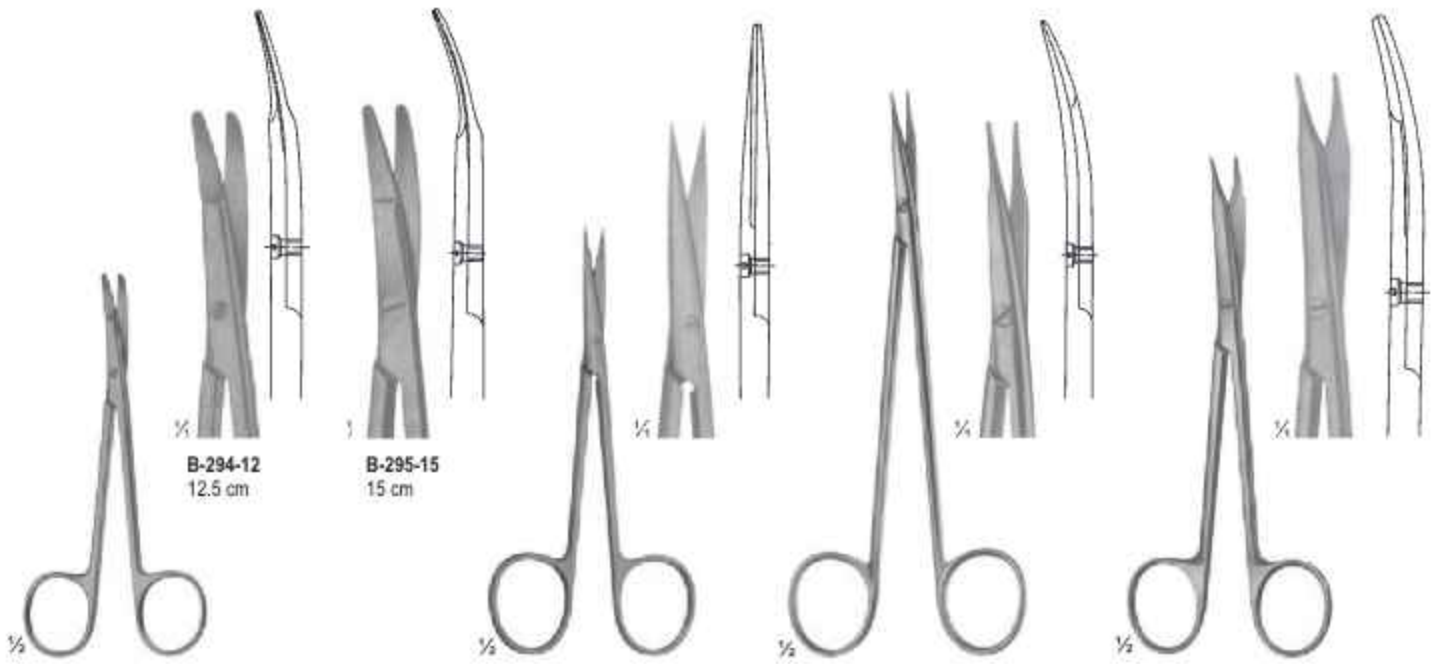

KILNER
B-294-12 - B-295-15
Special flat points for dissecting
and undermining the skin

KILNER
B-296-11
Fine dissecting scissors
11.5 cm

JAMESON
B-297-15
Dissecting scissors
15 cm

REYNOLDS
Dissecting scissors
B-298-14 - B-299-17
B-298-14 14.5 cm
B-299-17 17.5 cm

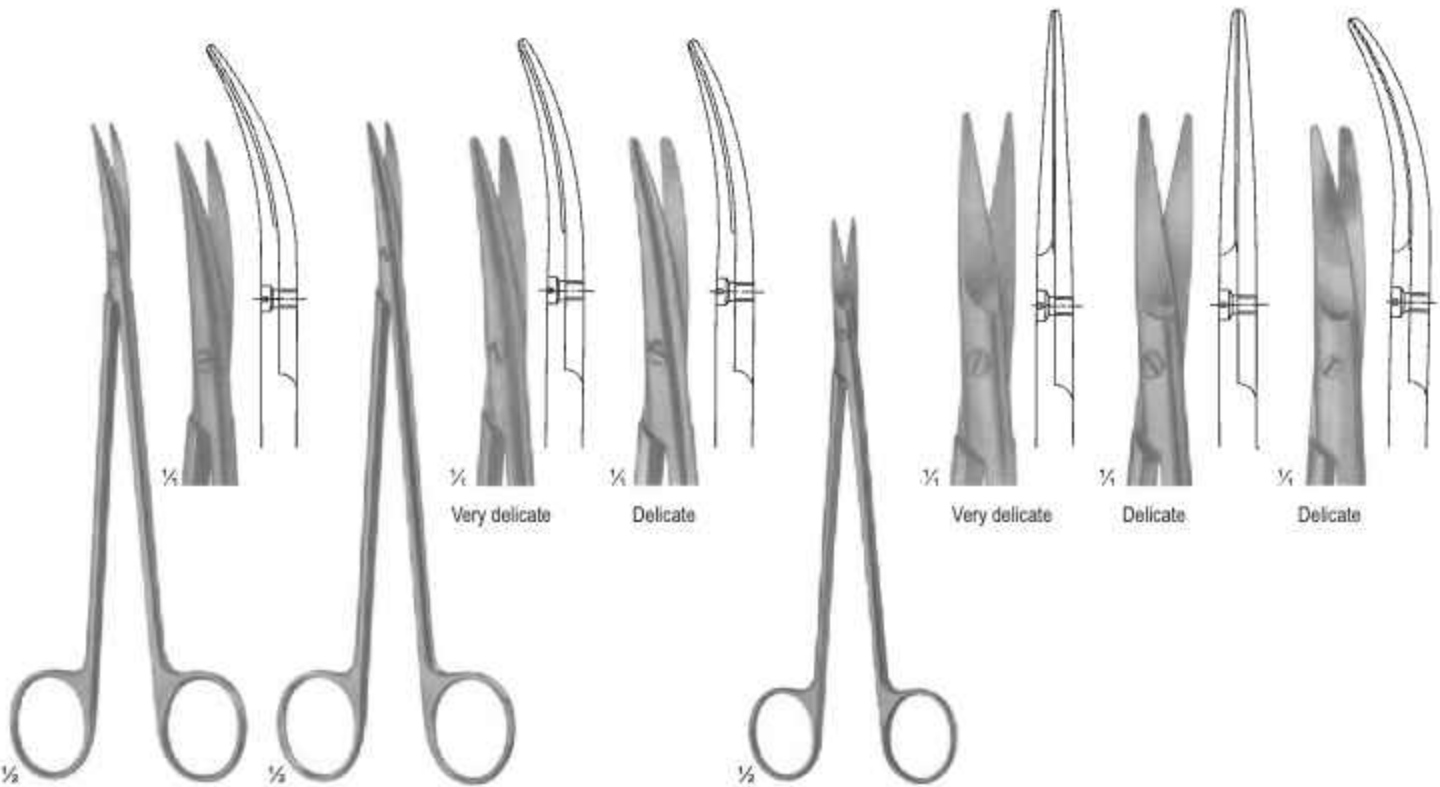

DE BAKEY
B-300-17
Ateriectomy scissors
17.5 cm

TOENNIS ADSON
B-301-17
Dissecting scissors
17.5 cm

TOENNIS
B-302-15
Dissecting scissors
15 cm

**SECTION
B**

Vessel Scissors

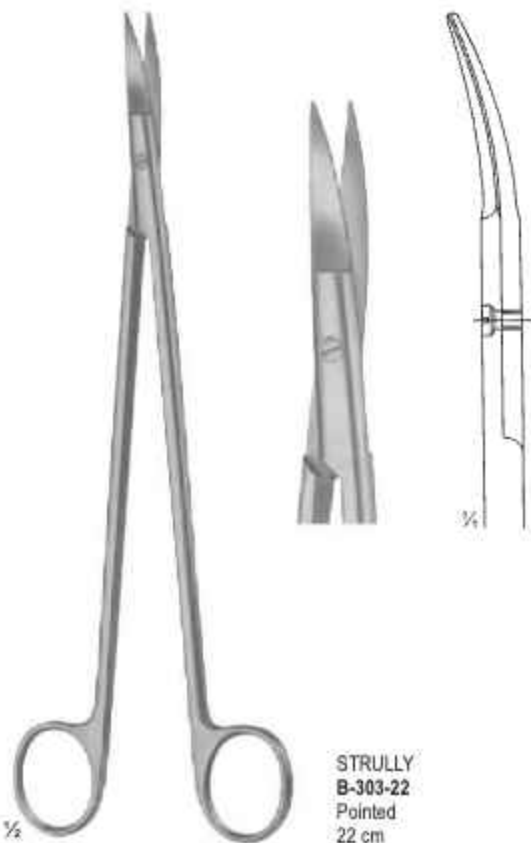

**STRULLY
B-303-22**
Pointed
22 cm

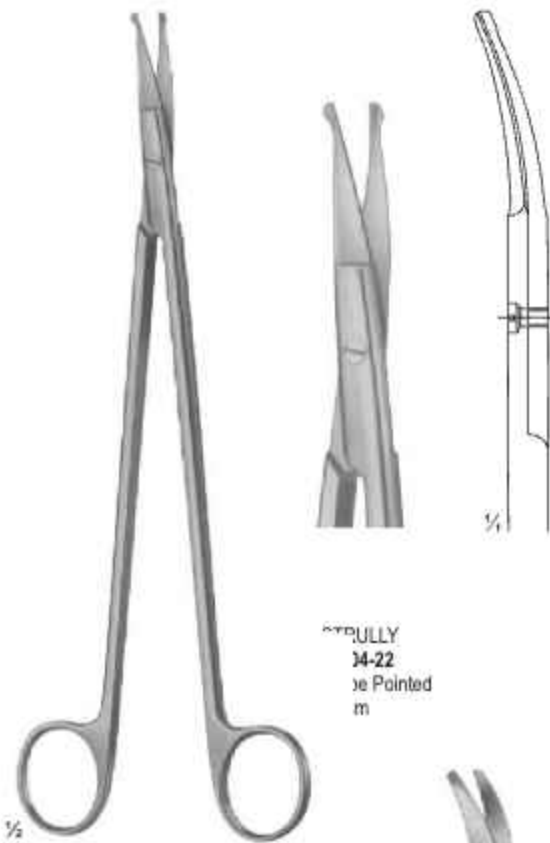

**STRULLY
B-304-22**
Pointed
22 cm



**FAVALORO
B-305-14**
14 cm

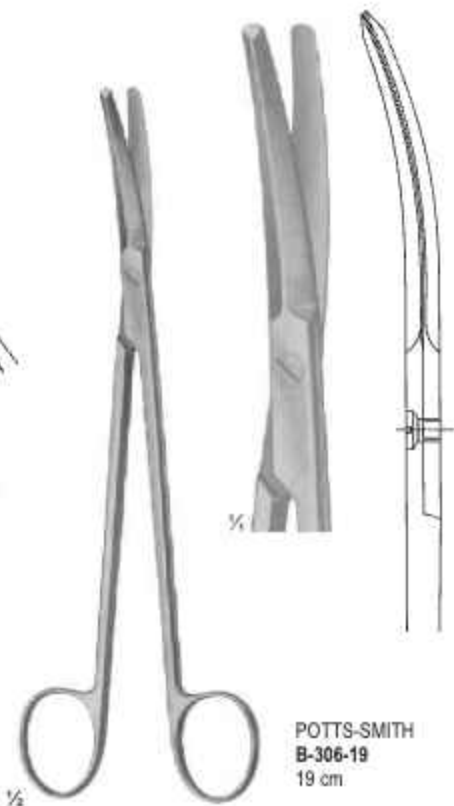

**POTTS-SMITH
B-306-19**
19 cm

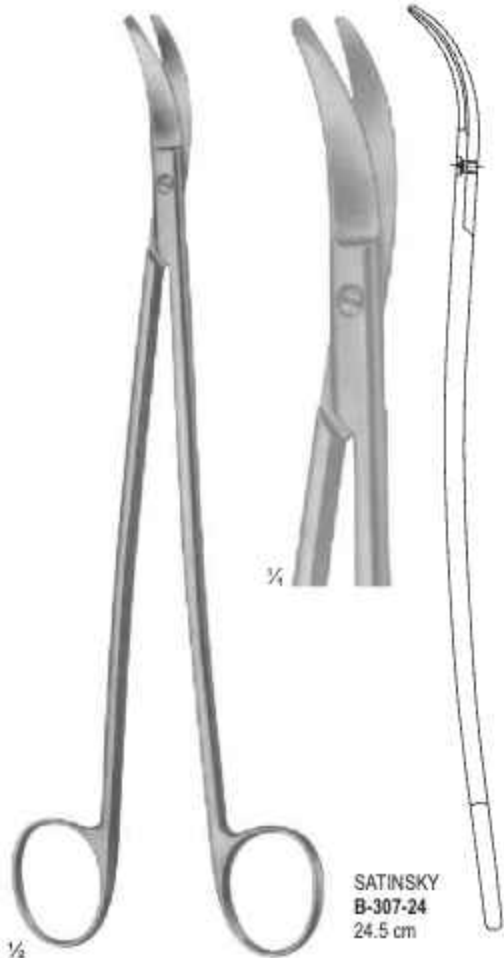

**SATINSKY
B-307-24**
24.5 cm



DIETRICH
B-308-19 - B-312-17



$\frac{1}{2}$
B-308-19
19 cm
25°



B-309-16
18.5 cm
45°



B-310-17
17.5 cm
60°



B-311-17
17.5 cm
90°



B-312-17
17.5 cm
120°



MIKRO-HEGEMANN
B-313-00 - B-317-00
18.5 cm



$\frac{1}{2}$
B-313-00
25°



B-314-00
45°



B-315-00
60°



B-316-00
90°



B-317-00
120°

**SECTION
B**

Vessel Scissors



POTTS-SMITH
B-318-00 - B-322-00
19 cm



B-318-00
60°



B-319-00
60°



B-320-00
40°



B-321-00
25°



B-322-00

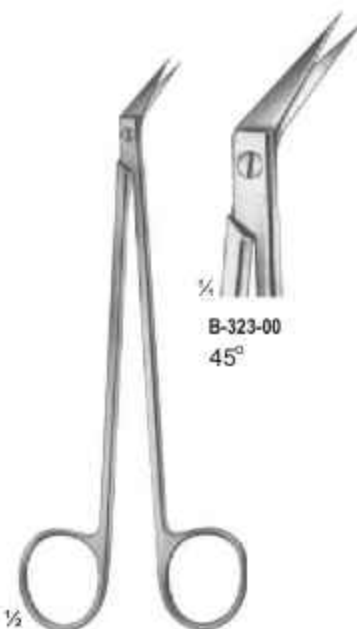

DE BAKKEY
B-323-00 - B-324-00
15.5 cm



B-323-00
45°



B-324-00
60°

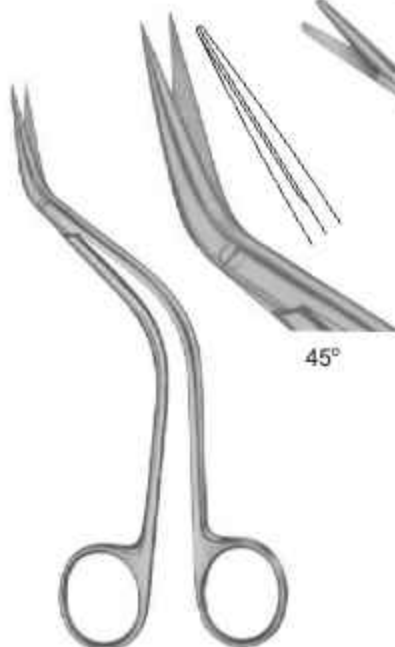

DEBAKEY
B-325-15
15.5 cm



45°



1/4



OLIVECRONA
Dura Scissors
B-326-12
12 cm

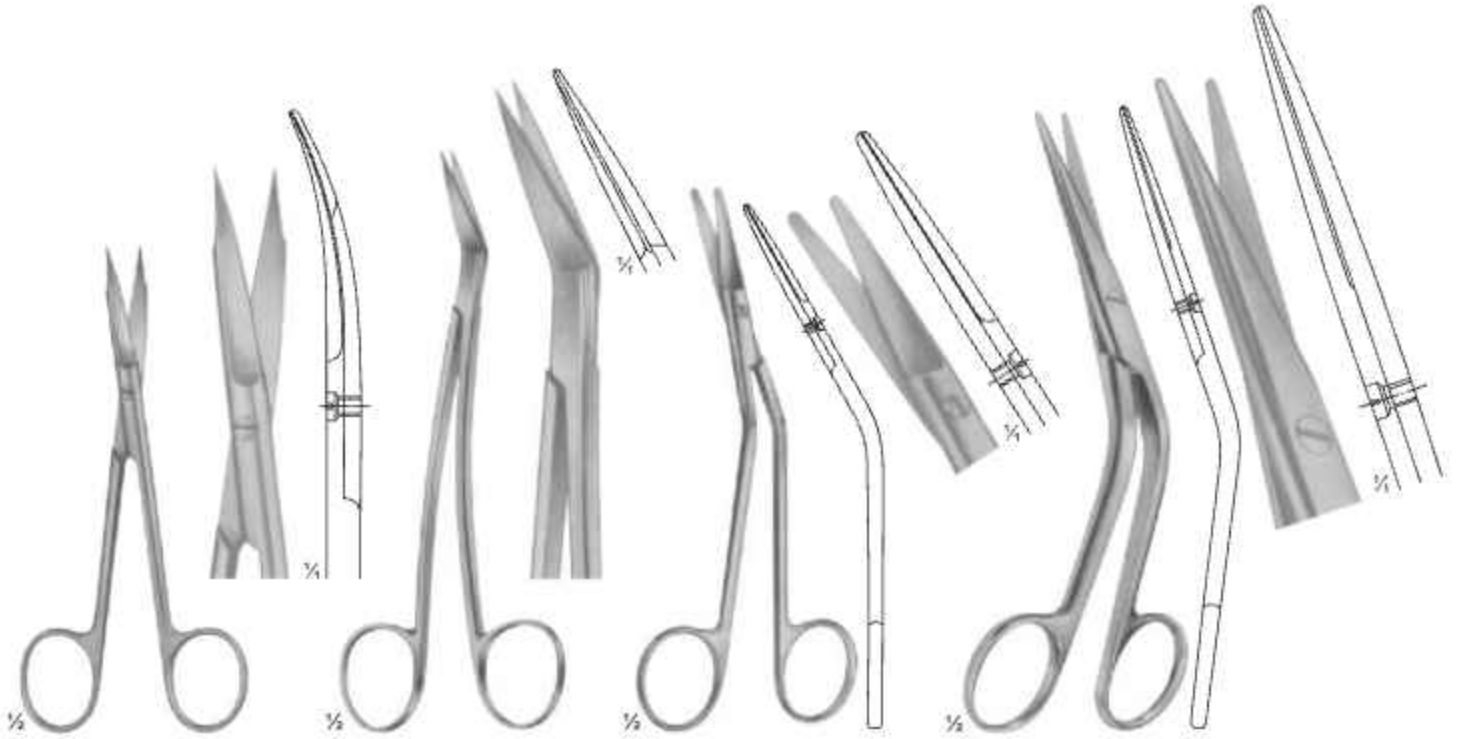

GOLDMAN-FOX
B-327-13
One Toothed Cutting Edge
13 cm

LOCKLIN
B-328-15
Curved Sideways,
1 Toothed Blade
15.5 cm

FOMON
B-329-14
Blades Serrated
14.5 cm

COTTLE
B-330-16
16.5 cm

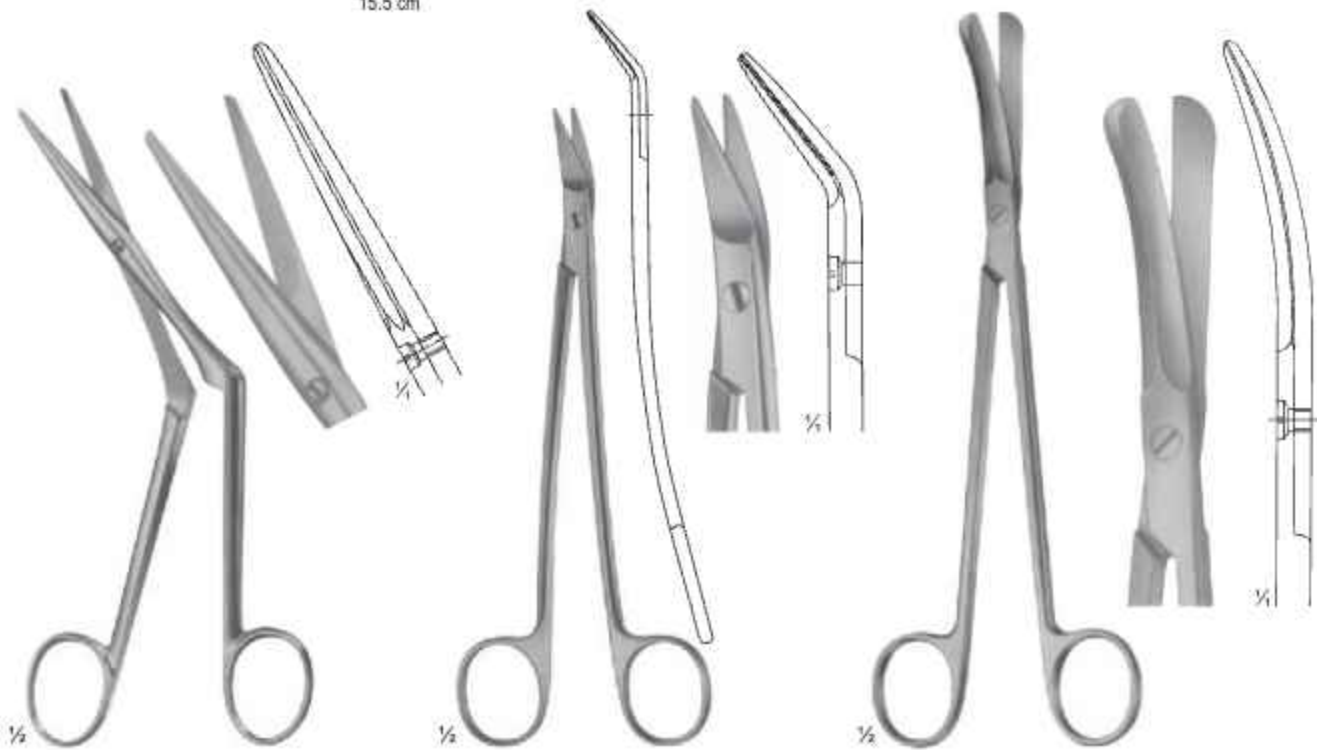

HEYMANN-KNIGHT
B-331-17
17.5 cm

DEAN
B-332-17
Blades Serrated
17 cm

GOOD
B-333-19
19.5 cm

**SECTION
B**

Ligature Scissors



**BENELUX
surgical**



SPENCER
B-334-09 - B-335-11
B-334-09 9 cm
B-335-11 11.5 cm

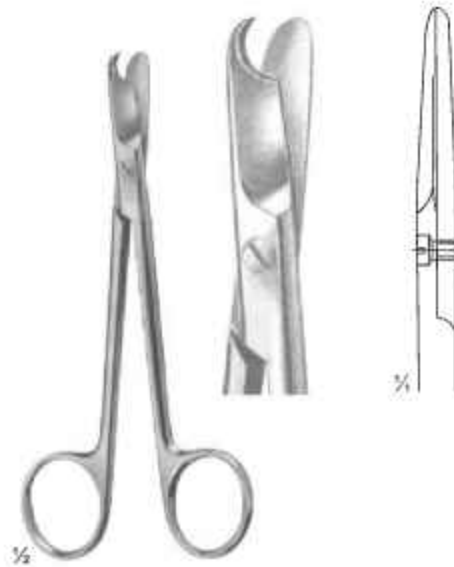

LITTAUER
B-336-13
 13.5 cm

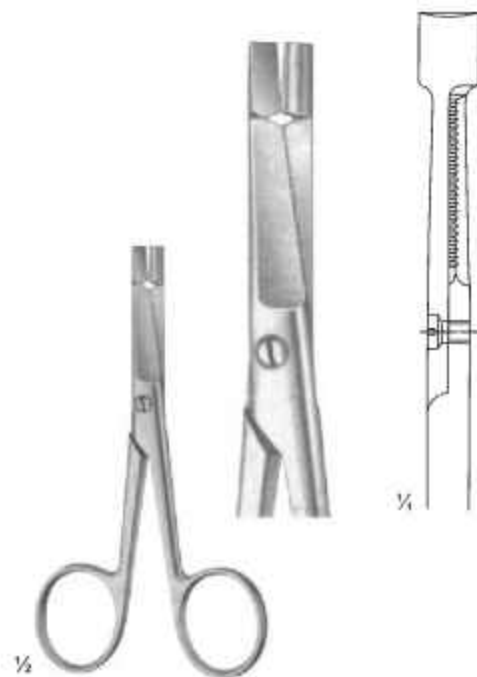

EISELSBERG
B-337-11
 11.5 cm

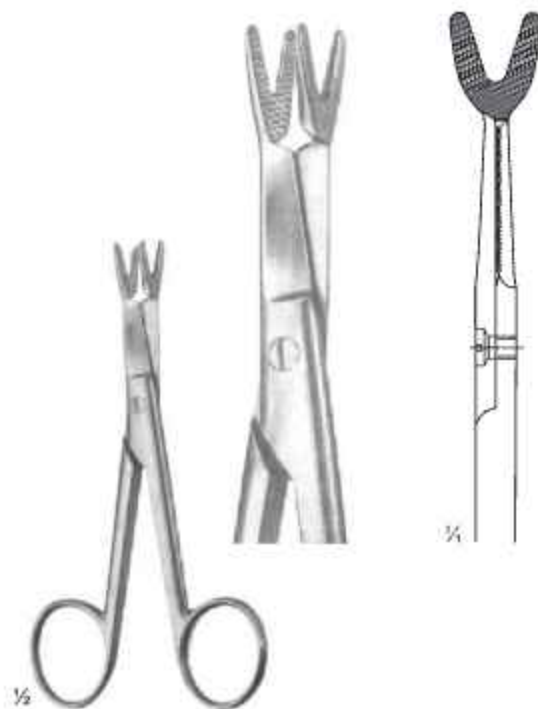

SCHOEMAKER-LOTH
B-338-12
 12,5 cm

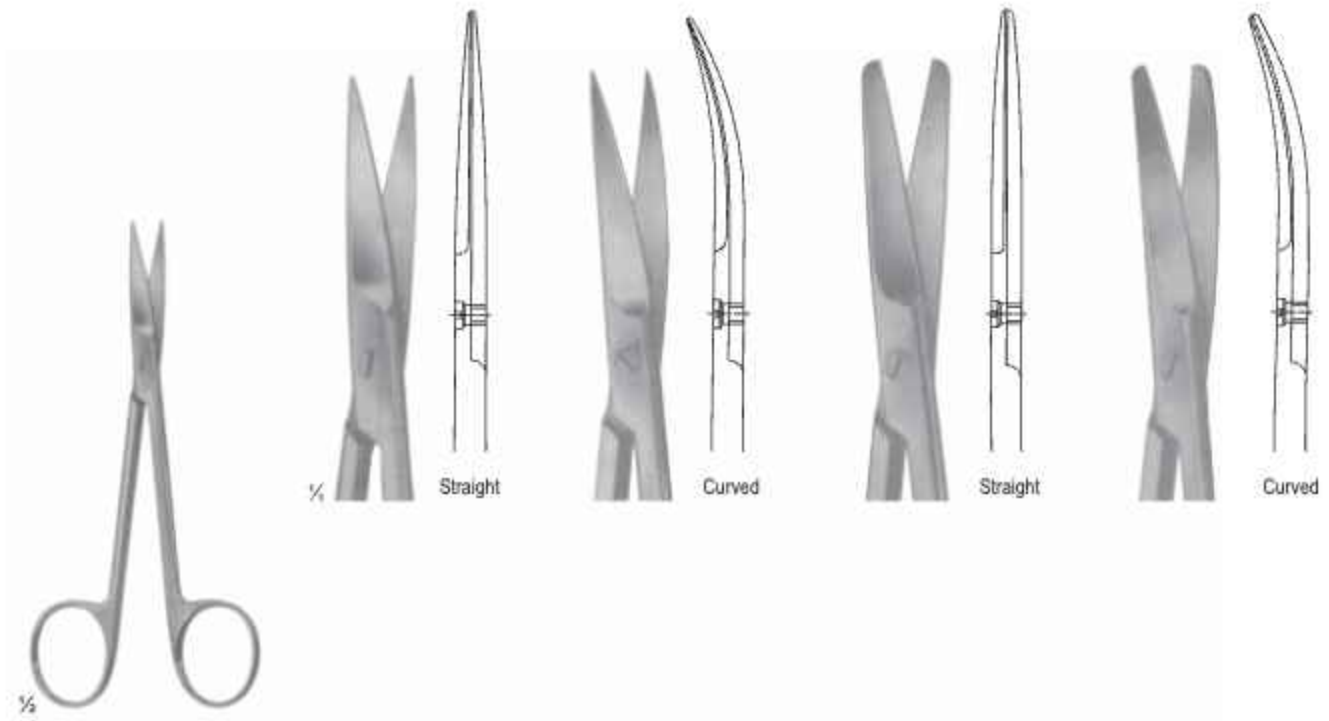

FINE OPERATING SCISSORS
B-339-12 - B-340-13
B-339-12 12 cm
B-340-13 13 cm



BONN
 Eye Scissors
B-341-09
 9 cm



NAIL SCISSORS
B-342-09
 9 cm



BABY NAIL SCISSORS
B-343-08
 8.5 cm

**SECTION
B**

Wire And Plate Scissors



B-344-11

Straight

Curved



B-345-11
Broad Blades

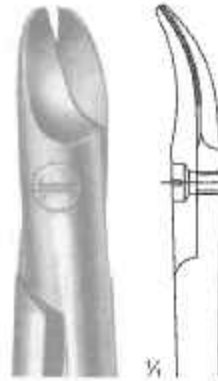

B-346-11



B-347-11

BEEBEE
B-344-11 - B-347-11
11 cm

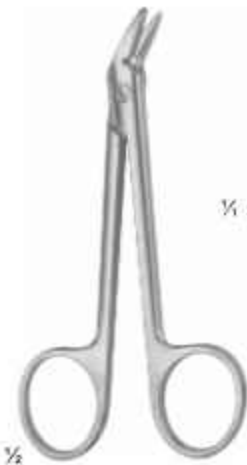

B-348-12
1 Blade Serrated
12 cm



STRACK
B-349-10
10 cm

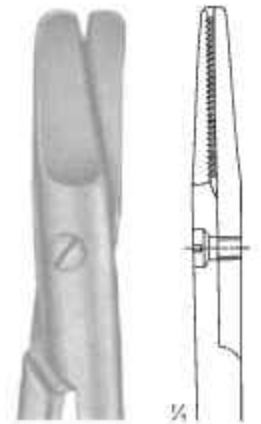

HARVEY
B-350-12
12.5 cm



DAMMSCHERE
B-351-21
Bowel Scissors
21 cm

DAMMSCHERE
B-352-21
Bowel Scissors
21 cm

LLOYD-DAVIES
(GOLIGHER'S)
B-353-25
Rectal Scissors
25.5 cm

STELZNER
B-354-31
Rectal Scissors
31 cm

SECTION
B

Ligature Scissors TC



BENELUX
surgical

TC **GOLD**



B-355-14
14.5 cm



B-356-18
18 cm



B-357-20
20.5 cm



1/2



B-358-23
23 cm



B-359-25
25 cm



B-360-30
30 cm

LIGATURE SCISSORS
B-355-14 - B-360-30
for synthetic suture material,
one toothed cutting edge

TC **GOLD**



1/2

LIGATURE SCISSORS
B-361-14 - B-363-23
for synthetic suture material,
one toothed cutting edge

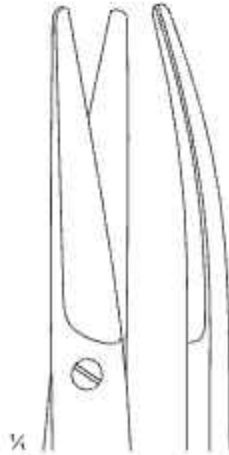

1/4

B-361-14
14.5 cm

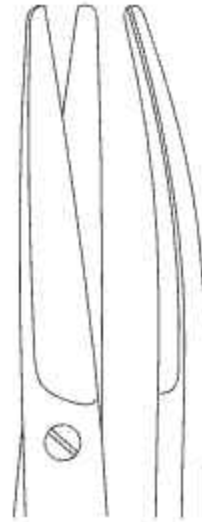

B-362-17
17 cm

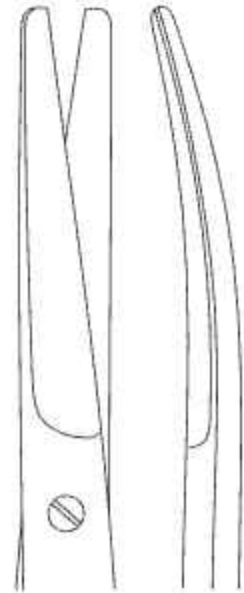

B-363-23
23 cm



1/2

IRIS
B-364-11
11.5 cm



1/4

SECTION
B

Dissecting Scissors TC



TC **GOLD**



B-365-18
18 cm

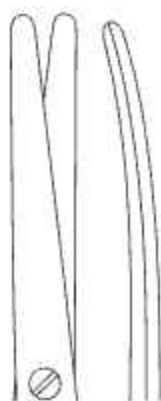

B-366-20
20 cm

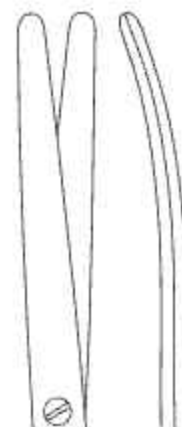

B-367-23
23 cm

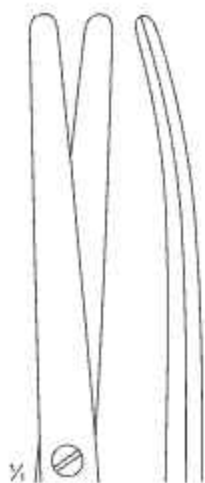

B-368-26
26 cm

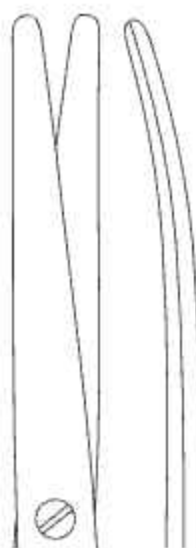

B-369-28
28.5 cm



B-370-31
31 cm



METZENBAUM
B-365-18 - B-370-31



B-371-12
12 cm



B-372-18
18 cm

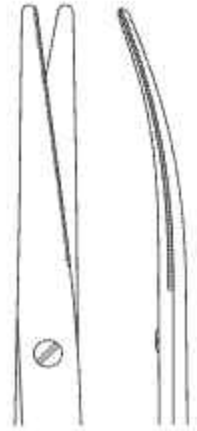

B-373-20
20 cm

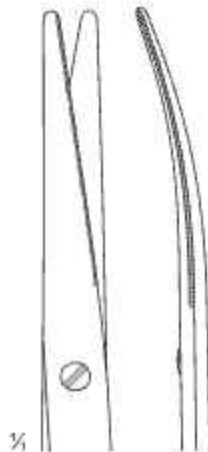

B-374-23
23 cm



B-375-25
25 cm

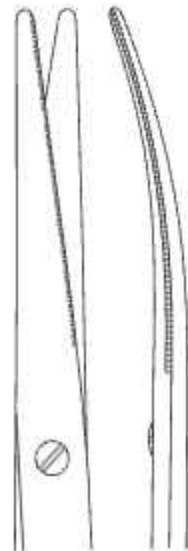

B-376-30
30 cm



Metzenbaum-Aquila
B-371-12 - B-376-30
one toothed cutting edge /
one cutting edge with knife cut

**SECTION
B**

Aquila-Scissors TC



TC GOLD



Metzenbaum-Aquila-Fino
B-377-14 - B-378-18
one toothed cutting edge/
one cutting edge with knife cut



B-377-14
14 cm

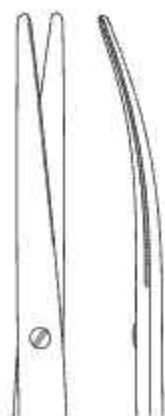

B-378-18
18 cm



TÖNNIS-ADSON-AQUILA
B-379-17
17.5 cm
one toothed cutting edge/
one cutting edge with knife cut

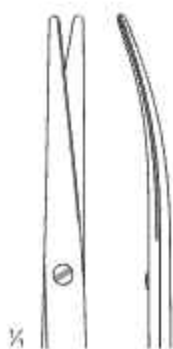

MAYO-LEXER-AQUILA
B-380-17
17.5 cm
one toothed cutting edge/
one cutting edge with knife cut

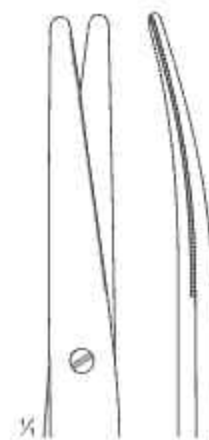



1/2

OPERATING SCISSORS
B-381-14 - B-383-14
14.5 cm



B-381-14

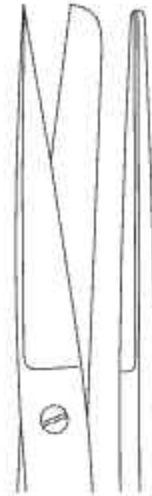

B-382-14

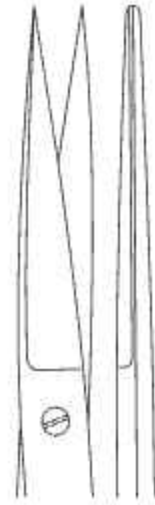

B-383-14



1/2

OPERATING SCISSORS
B-384-14 - B-386-14
14.5 cm

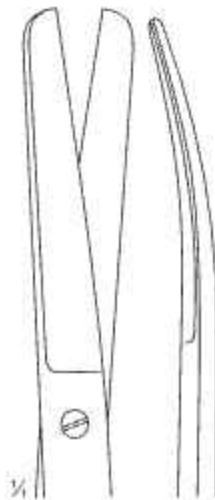

B-384-14

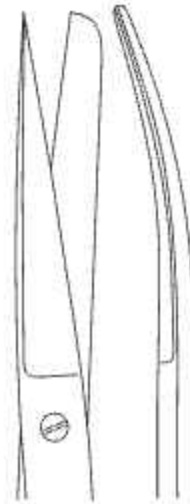

B-385-14

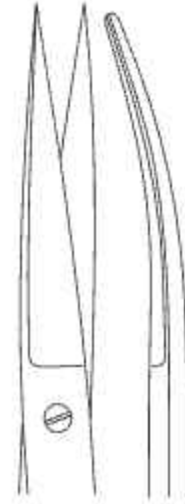

B-386-14

SECTION
B

Operating Scissors TC



TC **GOLD**



MAYO
B-387-14 - B-389-23

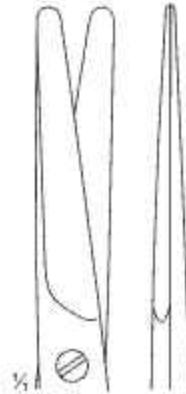

B-387-14
14.5 cm

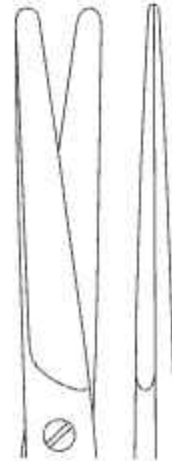

B-388-17
17 cm

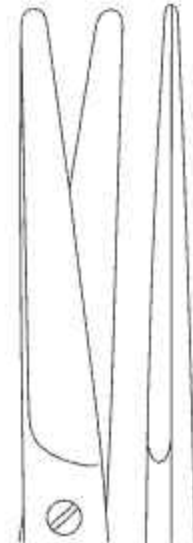

B-389-23
23 cm



MAYO
B-390-14 - B-392-23

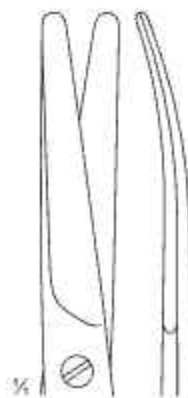

B-390-14
14.5 cm

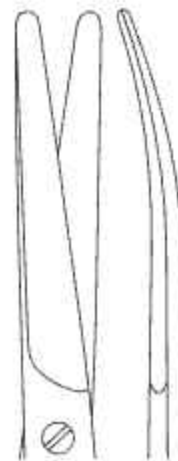

B-391-17
17 cm

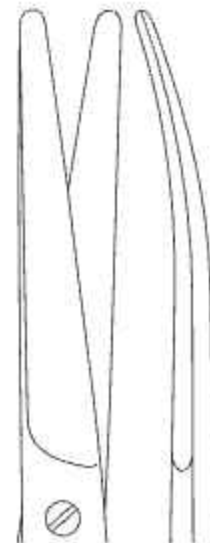

B-392-23
23 cm



1/2

MAYO-STILLE
B-393-14 - B-394-17

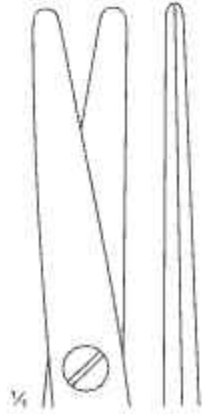

B-393-14
14.5 cm

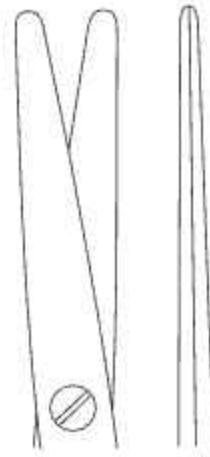

B-394-17
17 cm



1/2

MAYO-STILLE
B-395-14 - B-396-17

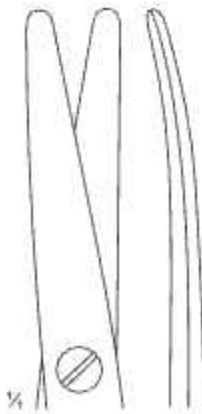

B-395-14
14.5 cm

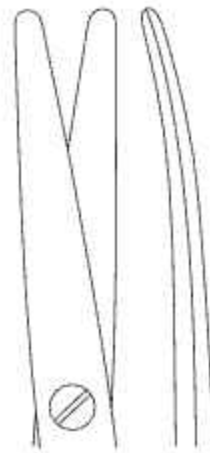

B-396-17
17 cm

SECTION
B

Dissecting Scissors TC

TC **GOLD**



METZENBAUM
B-397-11 - B-398-14

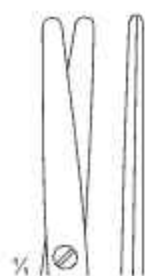

B-397-11
11.5 cm



B-398-14
14.5 cm



METZENBAUM
B-399-11 - B-400-14

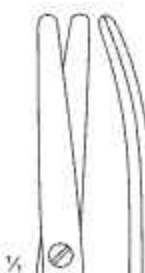

B-399-11
11.5 cm



B-400-14
14.5 cm



B-401-18
18 cm

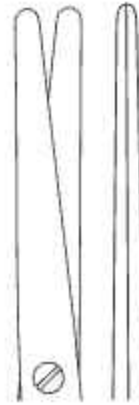

B-4B-20
20 cm



B-403-23
23 cm



METZENBAUM
B-401-18 - B-406-31

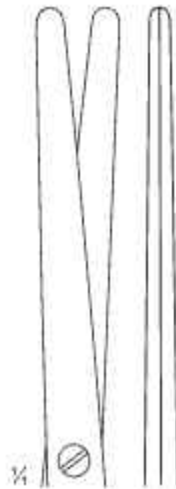

B-404-26
26 cm

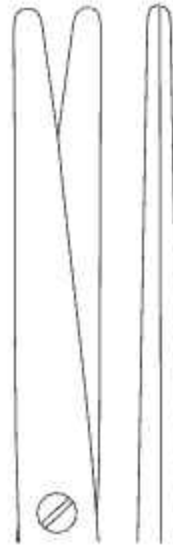

B-405-28
28.5 cm

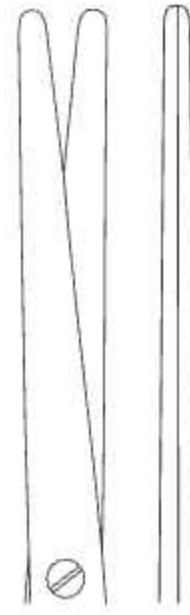

B-406-31
31 cm

SECTION
B

Dissecting Scissors TC



TC **GOLD**

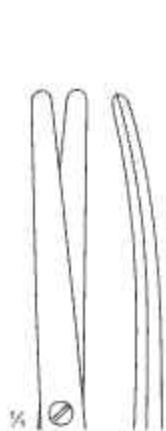

B-407-18
18 cm

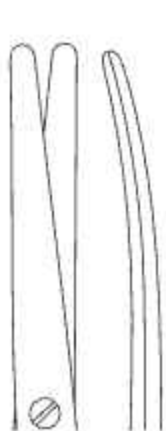

B-408-20
20 cm

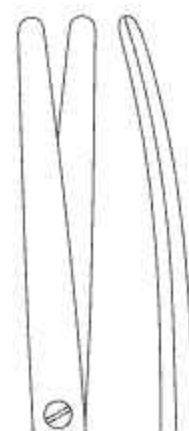

B-409-23
23 cm



METZENBAUM
B-407-18 - B-412-31

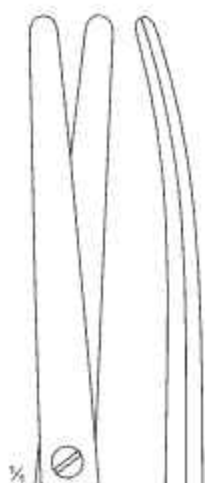

B-410-26
26 cm

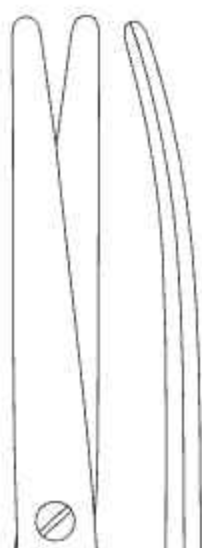

B-411-28
28.5 cm



B-412-31
31 cm

TC **GOLD**



½

METZENBAUM-THOREK
B-413-20 - B-415-28

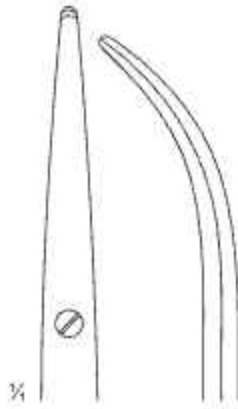

B-413-20
20 cm

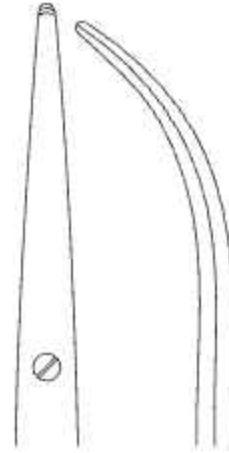

B-414-23
23 cm

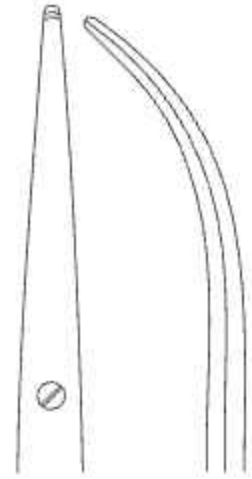

B-415-28
28 cm



½

JOSEPH
B-416-14 - B-417-14



B-416-14
14.5 cm



B-417-14
14.5 cm

**SECTION
B**

Operating And Dissecting Scissors TC



TC GOLD



**LEXER
B-418-16 - B-419-21**

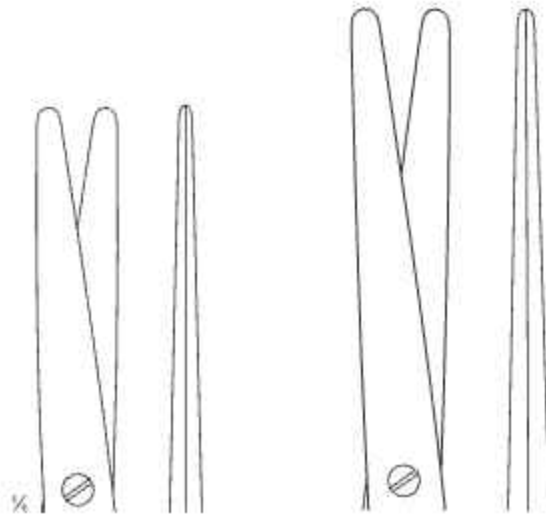

**B-418-16
16 cm**

**B-419-21
21 cm**



**LEXER
B-420-16 - B-421-21**

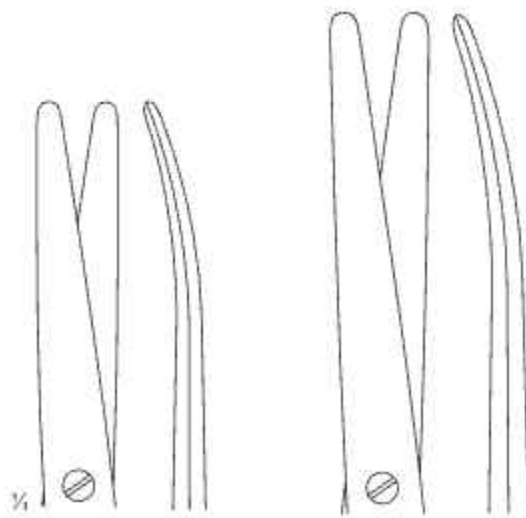

**B-420-16
16 cm**

**B-421-21
21 cm**



**MAYO-LEXER
B-422-16
16 cm**

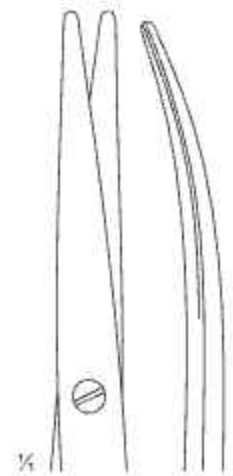

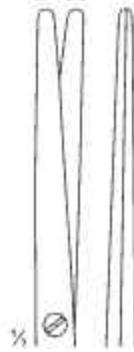

B-423-14



B-424-14

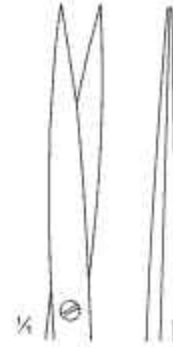

B-425-14

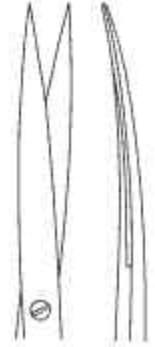

B-426-14



METZENBAUM-FINO
B-423-14 - B-424-14
14.5 cm

METZENBAUM-FINO
B-425-14 - B-426-14
14.5 cm



B-427-18



B-428-18

METZENBAUM-FINO
B-427-18 - B-428-18
18 cm

**SECTION
B**

Delicate Dissecting Scissors TC



TC GOLD



METZENBAUM-FINO
B-429-20 - B-432-28



B-429-20
20.5 cm



B-430-23
23 cm

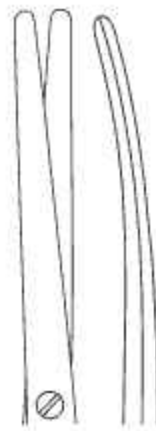

B-431-26
26 cm

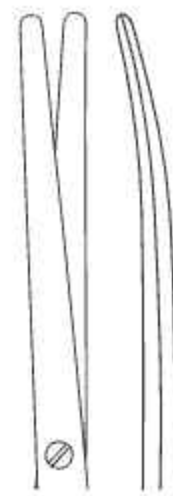

B-432-28
28.5 cm



METZENBAUM-FINO
B-433-18 - B-434-20

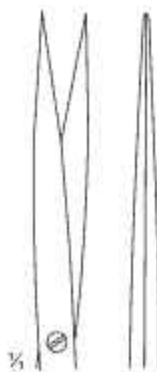

B-433-18
18 cm

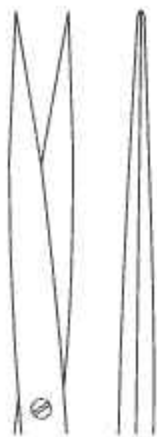

B-434-20
20 cm



METZENBAUM-LAHEY
B-435-14
14.5 cm
slender pattern



TC **GOLD**

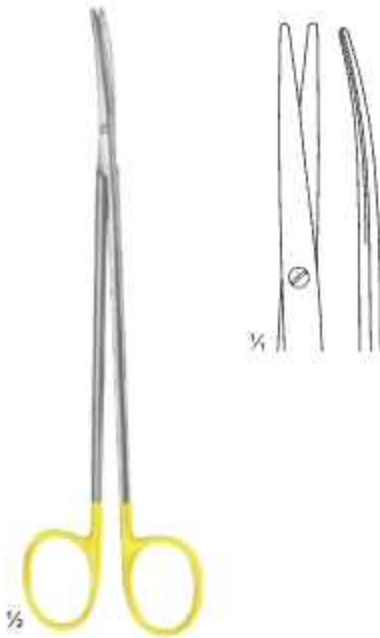

TOENNIS-ADSON
B-436-17
17.5 cm
slender pattern



METZENBAUM-FINO
B-437-20 - B-438-23
slender pattern

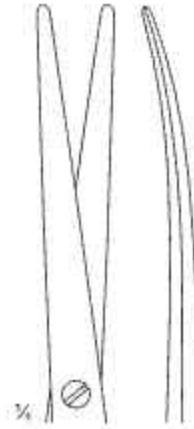

B-437-20
20.5 cm

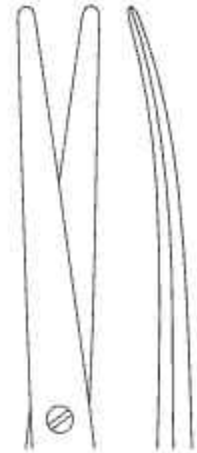

B-438-23
23 cm



METZENBAUM-FINO
B-439-18 - B-441-23
slender pattern



B-439-18
18 cm

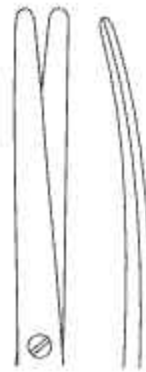

B-440-20
20.5 cm



B-441-23
23 cm

SECTION
B

Face-lift Scissors TC



BENELUX
surgical

TC **GOLD**



1/2

GORNEY
B-442-20 - B-443-23
one toothed cutting edge



1/4

B-442-20
20.5 cm



B-443-23
23 cm



1/2

REES
B-444-17
17 cm
one toothed cutting edge

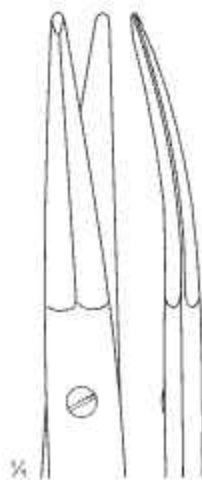

1/4



SIMS-AQUILA
B-445-20 - B-446-23
Uterine Scissors
one toothed cutting edge /
one cutting edge knife cut

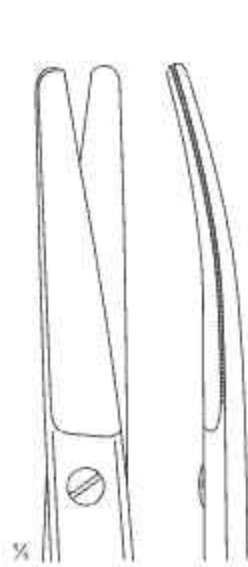

B-445-20
20.5 cm

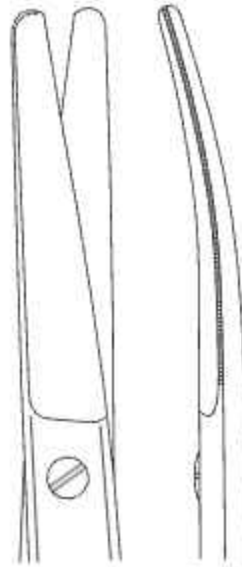

B-446-23
23 cm



SIMS
B-447-23 - B-448-23
23 cm

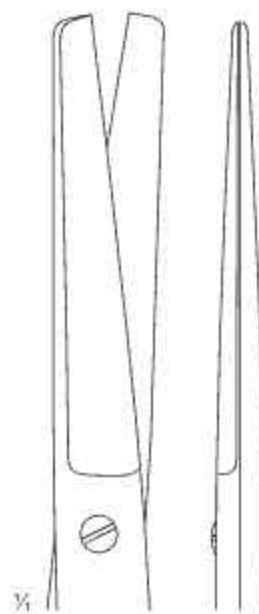

B-447-23

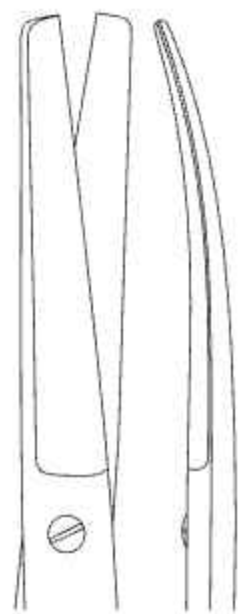

B-448-23

SECTION
B

Hysterectomy Scissors TC



TC **GOLD**

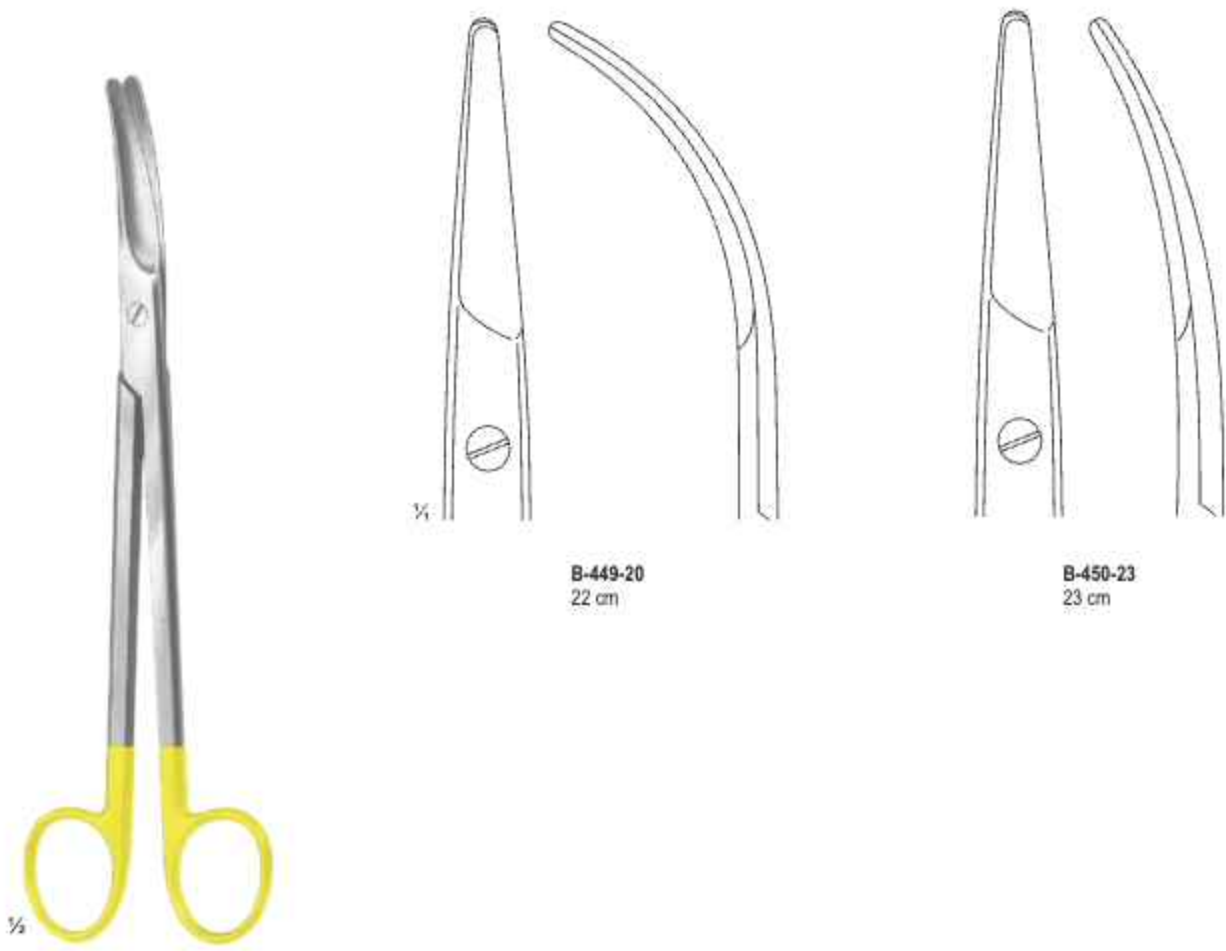

B-449-20
22 cm

B-450-23
23 cm

HYSTERECTOMY
B-449-20 - B-450-23
heavy pattern



B-451-13



B-452-13

GOLDMANN-FOX
B-451-13 - B-452-13
13 cm
one toothed cutting edge



B-453-11
11.5 cm



IRIS
B-454-11
11.5 cm

**SECTION
B**

Angled Scissors TC

TC GOLD



DE BAKEY
B-455-19 - B-460-22

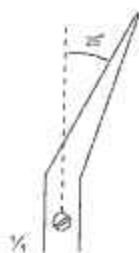

B-455-19
19 cm

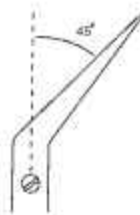

B-456-18
18.5 cm



B-457-18
18 cm

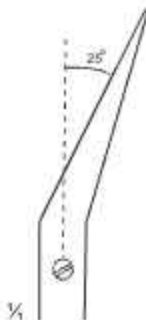

B-458-23
23 cm

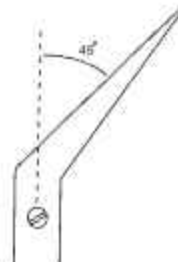

B-459-23
23 cm

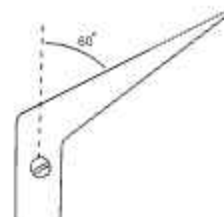

B-460-22
22 cm



B-461-11
11 cm



TC **GOLD**

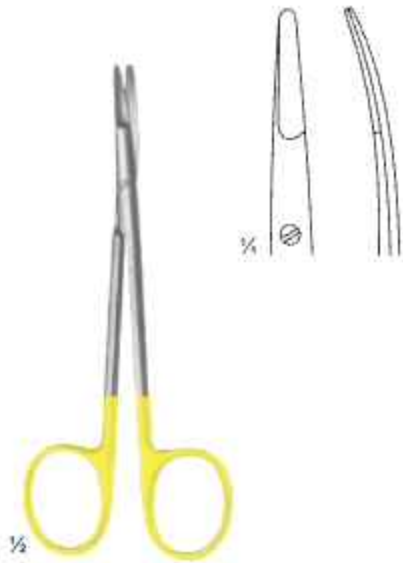

RAGNELL
B-462-12
12.5 cm



KELLY
B-463-16 - B-464-16

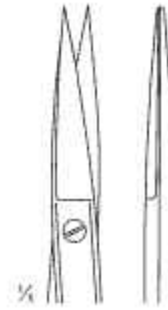

B-463-16
16 cm

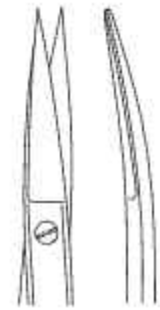

B-464-16
16 cm

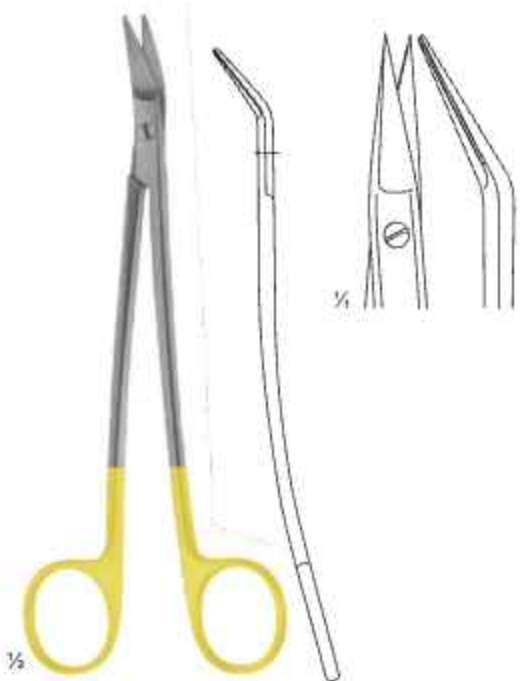

DEAN
B-465-17
17.5 cm
one toothed cutting edge

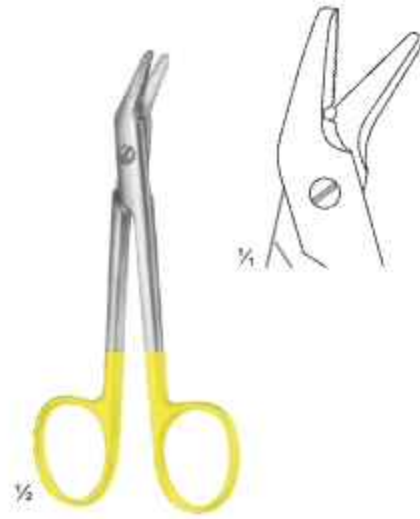

UNIVERSAL
B-466-12
12.5 cm
one toothed cutting edge

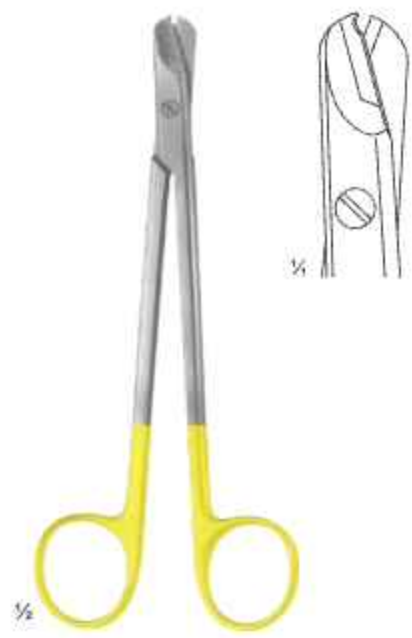

MARTIN
B-467-16
16 cm
Wire cutting scissors

**SECTION
B**

Delicate, Nasal And Tonsil Gum Scissors TC



**BENELUX
surgical**

TC GOLD



**FOMON
B-468-14**
Blades Serrated
14.5 cm



**COTTLE
B-469-16**
16.5 cm

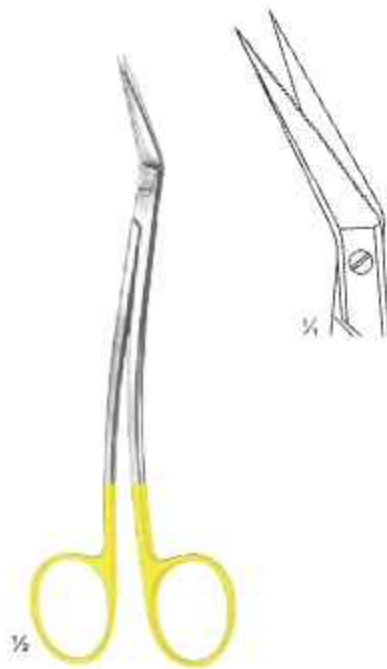

LOCKLIN
B-470-16
16 cm
one toothed cutting edge



LOCKLIN
B-471-16
16 cm
one toothed cutting edge



BENELUX
s u r g i c a l

SECTION

C

Page 59-73

- Dissecting & Delicate Tissue Forceps
- Delicate Dissecting Forceps
- Forceps, Bayonet - Shaped
- Delicate Tissue Forceps
- Tissue Forceps
- Lung Dissecting Forceps
- Forceps For Grasping Tissue, Tumors
- Ligature Forceps, Micro Forceps (light Patterns)
- Splinter And Cilia Forceps
- Forceps With Tungsten Carbide Inserts



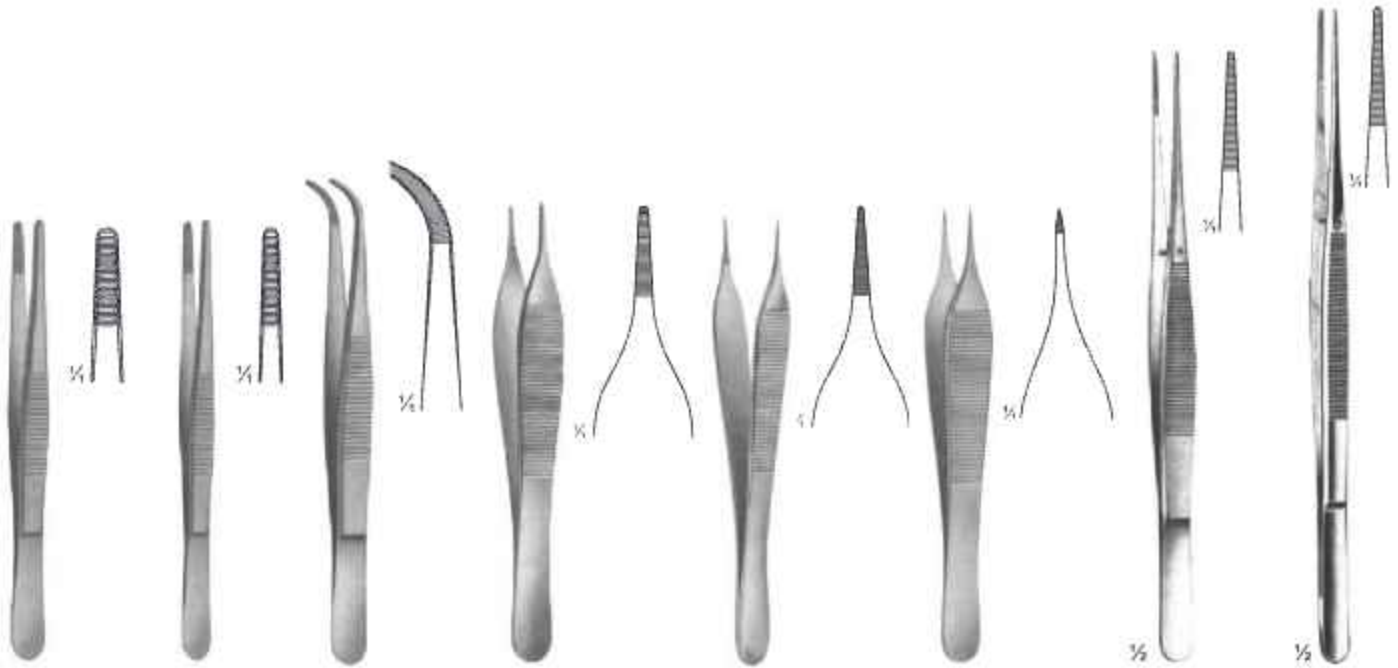

STANDARD
C-100-11 - C-109-30
C-100-11
11.5 cm
C-101-12
12 cm
C-102-13
13 cm
C-1C-14
14.5 cm
C-104-15
15 cm
C-105-16
16 cm
C-106-18
18 cm
C-107-20
20 cm
C-108-25
25 cm
C-109-30
30 cm

NARROW
C-110-11 - C-114-25
C-110-11
11.5 cm
C-111-13
13 cm
C-112-14
14.5 cm
C-113-18
18 cm
C-114-25
25 cm

NARROW
C-115-13 - C-116-14
C-115-13
13 cm
C-116-14
14.5 cm

ADSON
C-117-12 - C-118-15
C-117-12
12 cm
C-118-15
15 cm

MICRO-ADSON
C-119-12 - C-120-15
C-119-12
12 cm
C-120-15
15 cm

THOREK
Corneal Forceps
C-121-12
12 cm

POTTS-SMITH
C-122-18 - C-124-25
C-122-18
18 cm
C-123-21
21 cm
C-124-25
25 cm

TAYLOR
C-125-17 - C-126-18
C-125-17
17 cm
C-126-18
18 cm

**SECTION
C**

Delicate Dissecting Forceps





LUCAE
C-141-14
14 cm

JANSEN
C-142-16
16 cm

TAYLOR
C-143-18
18.5 cm

GRUENWALD
C-144-20
20 cm

COTTLE
C-145-14
Forceps with
jaws toothed
and serrated
14 cm

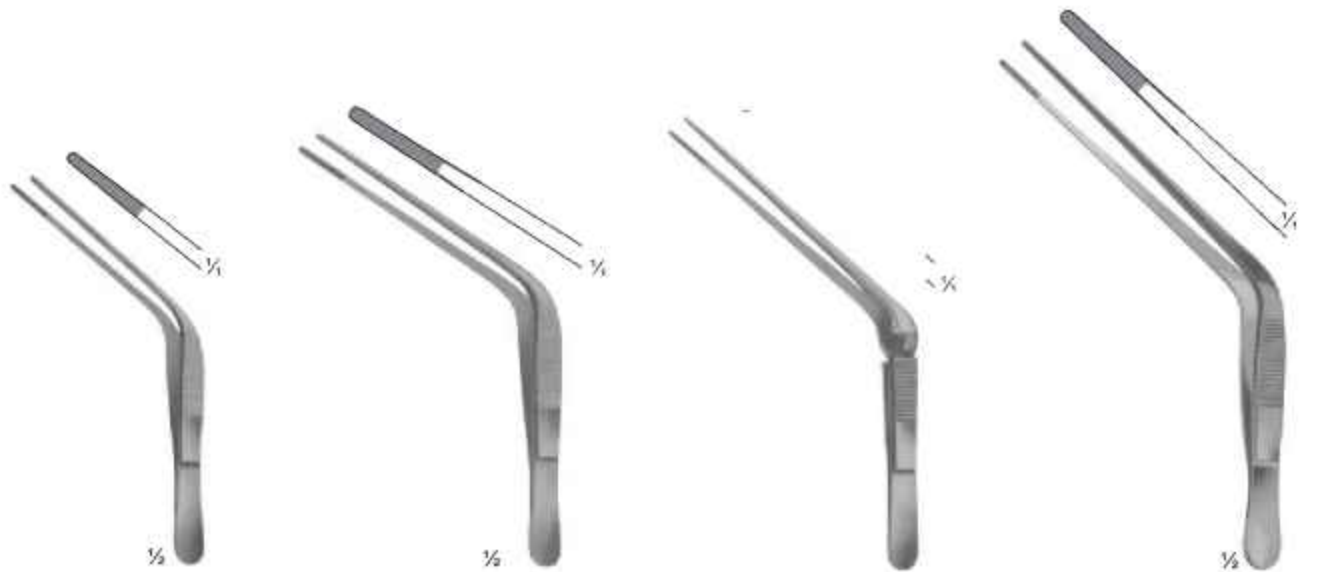

TROELTSCH
C-146-10 - C-147-11
C-146-10
10 cm
C-147-11
11.5 cm

WILDE
C-148-11
11.5 cm

TROELTSCH
C-149-12
cross action
12 cm

TROELTSCH
C-150-14
14 cm

SECTION
C

Forceps

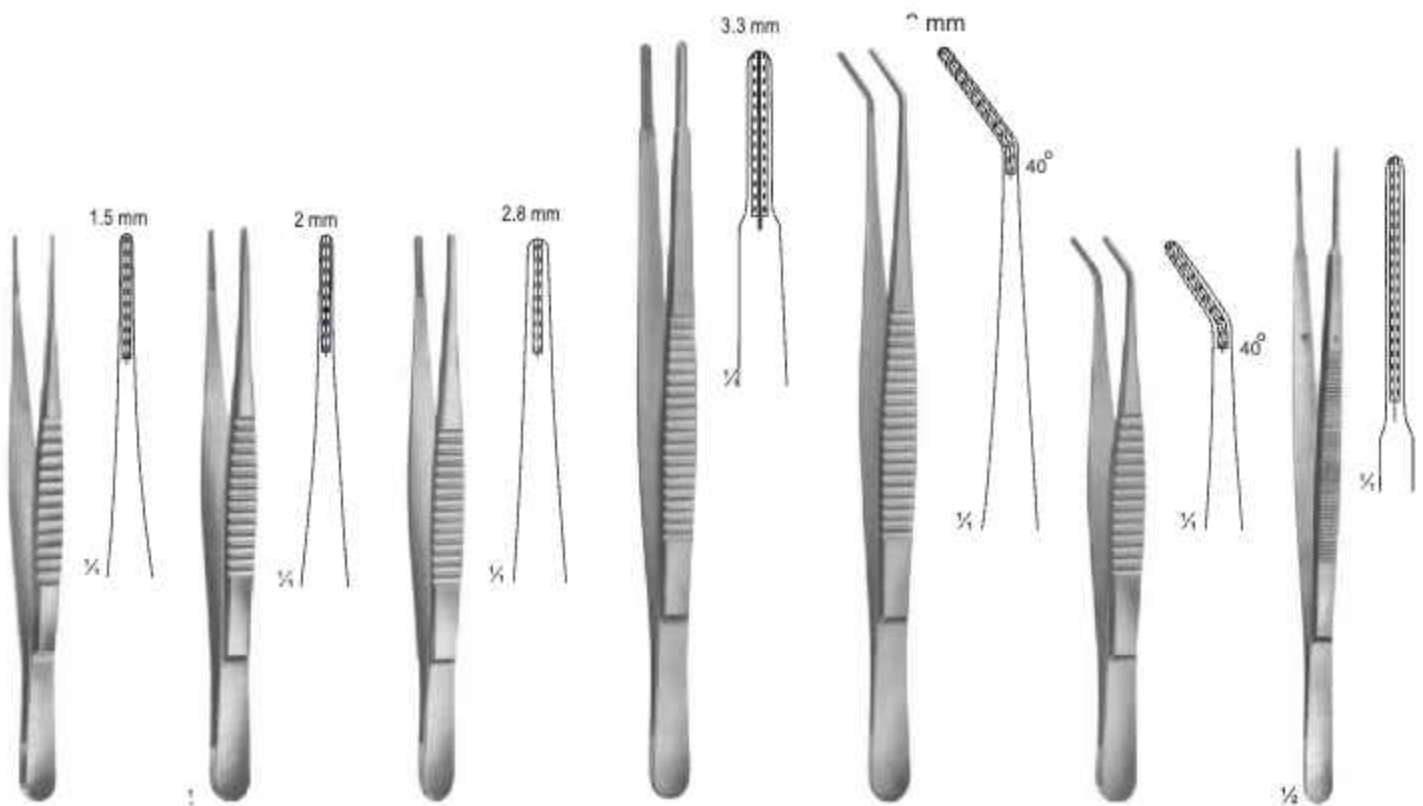

DE BAKEY
C-151-15 - C-152-20
C-151-15
15 cm
C-152-20
20 cm

DE BAKEY
C-153-15 - C-156-30
C-153-15
15 cm
C-154-20
20 cm
C-155-24
24 cm
C-156-30
30 cm

DE BAKEY
C-157-15 - C-160-30
C-157-15
15 cm
C-158-20
20 cm
C-159-24
24 cm
C-160-30
30 cm

DE BAKEY
C-161-20 - C-163-30
C-161-20
20 cm
C-162-24
24 cm
C-163-30
30 cm

DE BAKEY
C-164-20
20 cm

DE BAKEY
C-165-15
15 cm

GERALD
C-166-17
17.5 cm
C-167-23
23 cm

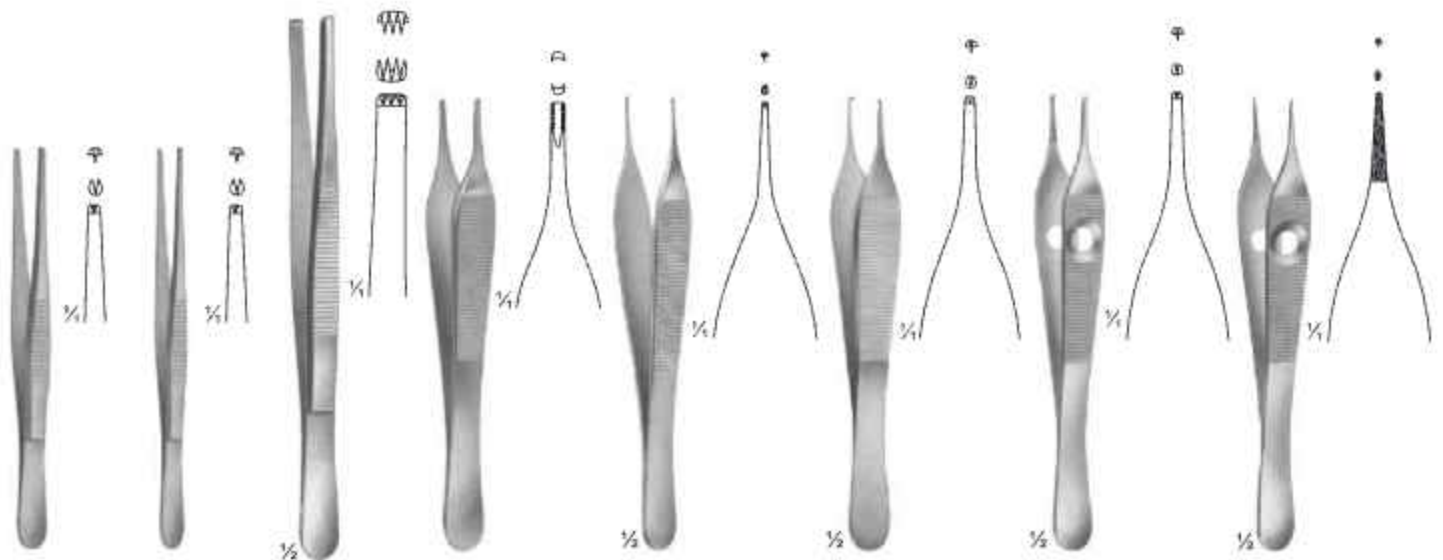

STANDARD
C-168-10
10.5 cm
C-169-11
11.5 cm
C-170-13
13 cm
C-171-14
14.5 cm
C-172-16
16 cm
C-173-18
18 cm
C-174-20
20 cm
C-175-25
25 cm
C-176-30
30 cm

NARROW
C-177-11
11.5 cm
C-178-13
13 cm
C-179-14
14.5 cm
C-180-18
18 cm
C-181-25
25 cm

3x4 teeth
C-182-14
14.5 cm
C-183-16
16 cm
C-184-20
20 cm

ADSON - BROWN
 Non-traumatic
C-185-12
12 cm

MICRO-ADSON
C-186-12
12 cm

ADSON
C-187-12
12 cm

ADSON
C-188-12
12 cm
C-189-15
15 cm

ADSON
C-190-12
12 cm



GRAEFE
C-191-11
11 cm
C-192-11
11.5 cm
C-193-13
13 cm
C-194-14
14.5 cm
C-195-16
16 cm



MC INDOE
C-196-15
15 cm



SEMKEN
C-197-12
12.5 cm
C-198-12
12.5 cm
C-199-15
15 cm



GERALD
C-200-17
17.5 cm
C-201-17
17.5 cm
C-202-23
23 cm



WAUGH
C-203-18
18 cm
C-204-20
20 cm
C-205-25
25 cm
C-206-30
30.5 cm



BRUPHY
C-207-20
20 cm



BROWN
C-208-12
12 cm



GRAEFE
C-209-10
10 cm



GRAEFE
C-210-10
With Catch
10 cm



GILLIES
C-211-15
15.5 cm



C-212-14
LUCAE
1x2 teeth
14 cm



C-213-11
TROELTSCH
1X2 teeth
11 cm



LANE
C-214-15
15 cm
C-215-15
15 cm
C-216-17
17.5 cm

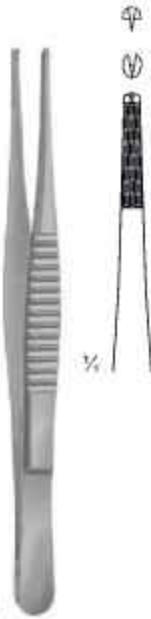

STRASSBURGER
MODELL
C-217-15
15 cm
C-218-20
20 cm

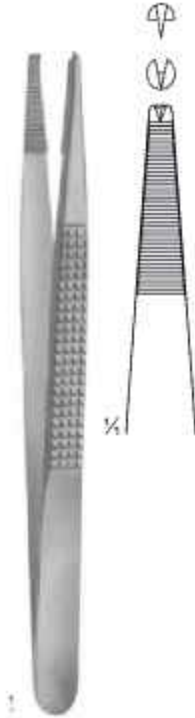

BONNEY
C-219-17
17.5 cm

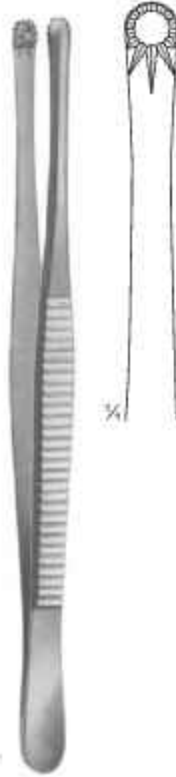

RUSS MODELL
C-220-20
20 cm

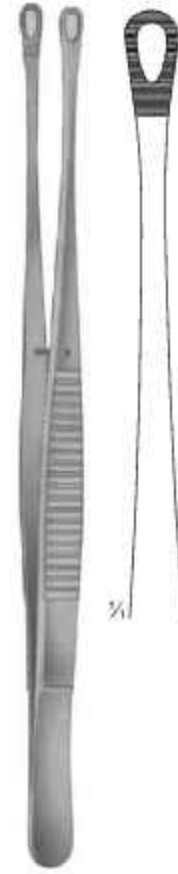

TUTTLE
C-221-23
Lung Dissecting
Forceps
23 cm

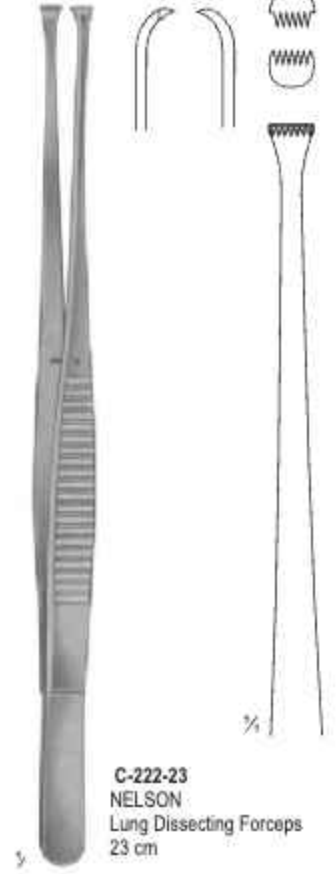

C-222-23
NELSON
Lung Dissecting Forceps
23 cm



STILLE
C-223-15
15 cm



STILLE
C-224-15
15 cm



STONE
C-225-15
15 cm



LERCHE
C-226-15
15 cm



DUVAL
Intestinal Forceps
C-227-14
14.5 cm



DENIS-BROWNE
Intestinal Forceps
C-228-19
19 cm

SECTION
C

Forceps For Grasping Tissue, Tumors

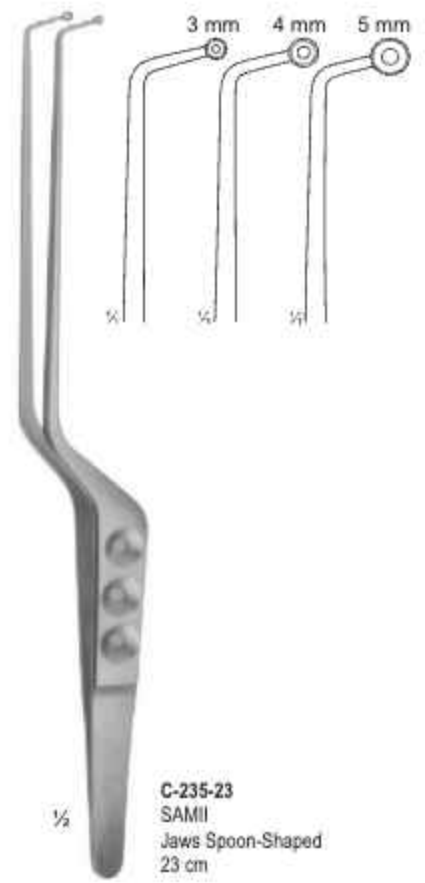

YASARGIL-SAMI
Jaws Spoon-Shaped
C-229-22
22 cm 3 mm
C-230-22
22 cm 5 mm
C-231-24
24 cm 3 mm
C-232-24
24 cm 5 mm
C-233-24
24 cm 7 mm



HUNT
C-236-20
Tumor-and Vessel Forceps
20 cm



HUNT
C-237-20
Tumor-and Vessel Forceps
20 cm



YASARGIL
C-238-20
Tumor-and Vessel Forceps
20 cm

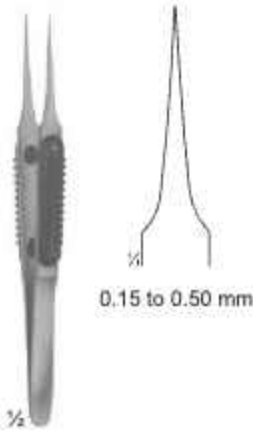

0.15 to 0.50 mm

MULLER
C-239-11
11 cm 0.15 mm
C-240-11
11 cm 0.20 mm
C-241-11
11 cm 0.30 mm
C-242-11
11 cm 0.50 mm
C-243-11

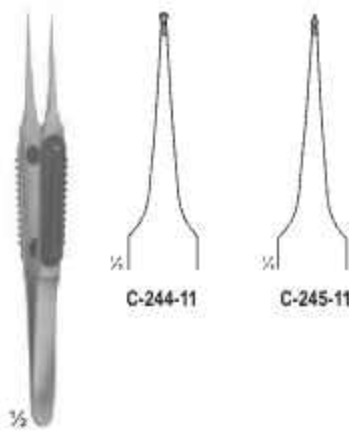

C-244-11 **C-245-11**

MULLER
C-244-11
11 cm
C-245-11
11 cm



YASARGIL
C-246-18
18.5 cm



YASARGIL
C-247-18
18 cm
C-248-20
20 cm
C-249-22
22 cm
C-250-24
24 cm

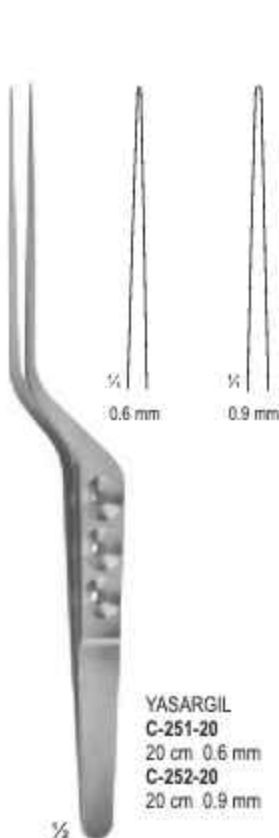

YASARGIL
C-251-20
20 cm 0.6 mm
C-252-20
20 cm 0.9 mm

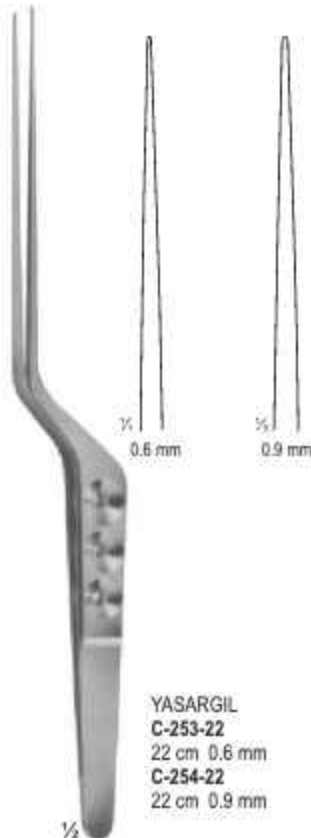

YASARGIL
C-253-22
22 cm 0.6 mm
C-254-22
22 cm 0.9 mm

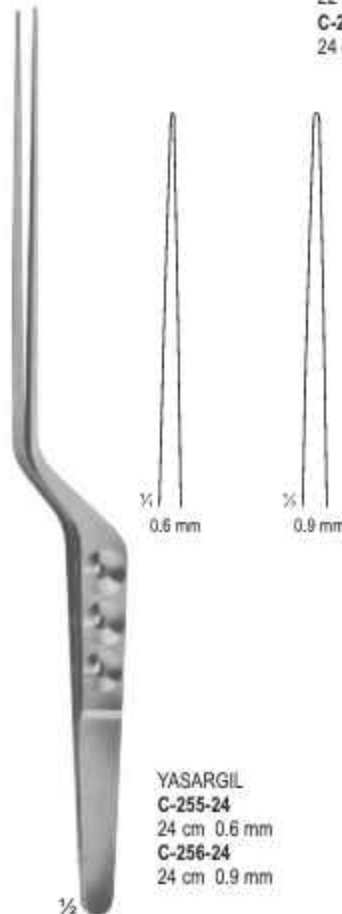

YASARGIL
C-255-24
24 cm 0.6 mm
C-256-24
24 cm 0.9 mm

**SECTION
C**

Splinter And Cilia Forceps



FEILCHENFELD
C-257-07
7.5 cm
C-258-09
9 cm
C-259-11
11.5 cm

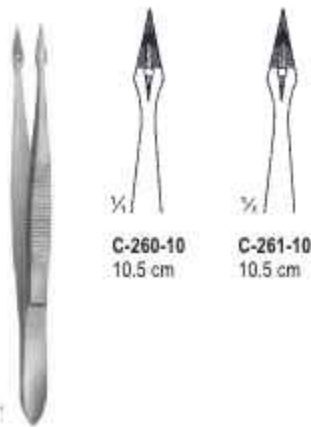

**C-260-10 - C-261-10
HUNTER**



PEET
12 cm



C-263-14
14 cm



C-265-10
10.5 cm



RALK
C-266-14
14 cm



C-267-15
15 cm



C-268-14
14 cm

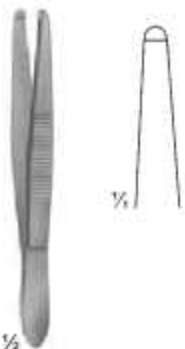

BEER
C-269-09
9 cm



DOUGLAS
C-270-09
9 cm

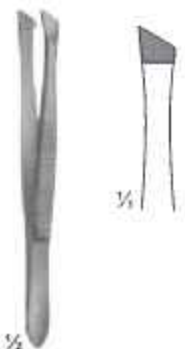

LITTAUER
C-271-09
9 cm



SAUPE
C-272-10
10.5 cm

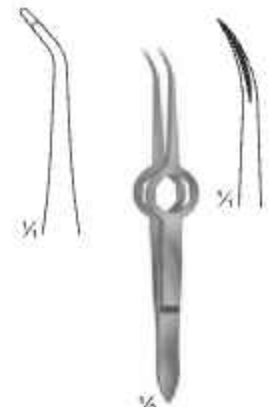

SCHAAF
C-273-09
9.5 cm

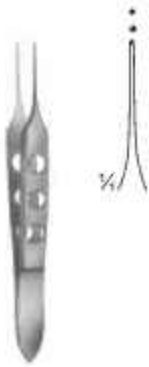

BISHOP-HARMON
C-274-08
8.5 cm

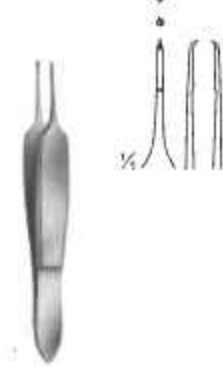

ST.MARTIN
C-275-08
8 cm

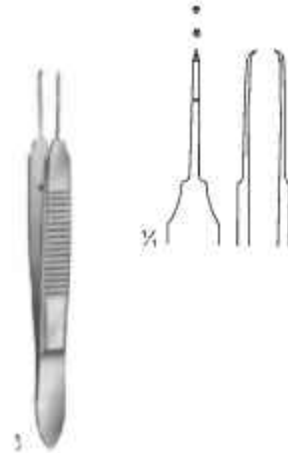

CASTROVIEJO
C-276-10
teeth 0.9 mm
10 cm

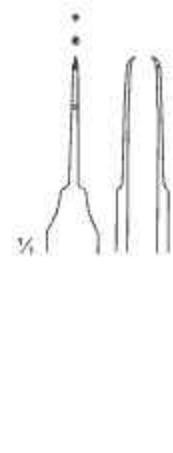

CASTROVIEJO
C-277-10
teeth 0.5 mm
10 cm

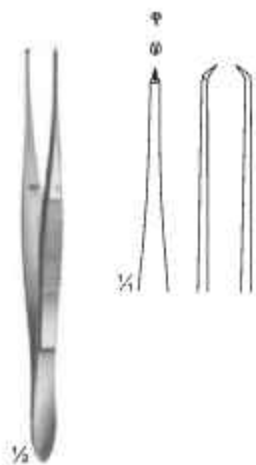

ELSCHING
C-278-11
11 cm



GILL
C-279-07
7.5 cm



GILL - HESS
C-280-07
7.5 cm



HESS
C-281-07
7 cm

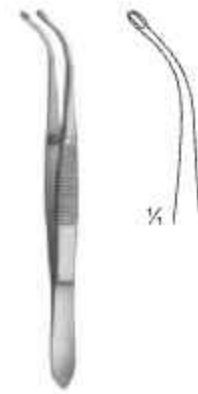

ARRUGA
C-282-10
10 cm

**SECTION
C**

Forceps With Tungsten Carbide Inserts TC



TC GOLD



- STANDARD**
- C-283-14 14.5 cm
 - C-284-16 16 cm
 - C-285-18 18 cm
 - C-286-20 20 cm
 - C-287-25 25 cm
 - C-288-30 30 cm



- STANDARD**
- C-289-14 14.5 cm
 - C-290-16 16 cm
 - C-291-18 18 cm
 - C-292-20 20 cm
 - C-293-25 25 cm
 - C-294-30 30 cm



- STANDARD**
- C-295-12 12.5 cm
 - C-296-15 15 cm



- WANGENSTEEN**
- C-297-15 15 cm
 - C-298-23 23 cm
 - C-299-25 25 cm



- ADSON**
- C-300-12 12 cm
 - C-301-15 15 cm

- ADSON**
- C-302-12 12 cm
 - C-303-15 15 cm

ADSON
C-300-12 - C-303-15



- MICRO ADSON**
- C-304-12 12 cm

- MICRO ADSON**
- C-305-12 12 cm

MICRO ADSON
C-304-12 - C-305-12



ADSON-BROWN
C-306-12 12 cm



- SEMKEN**
- Normal
 - C-307-16 16 cm
 - C-308-18 18 cm

- SEMKEN**
- Mini
 - C-309-16 16 cm
 - C-310-18 18 cm

SEMKEN
C-307-16 - C-310-18



GILLIES
C-311-15
15 cm



MC INDOE
C-312-15
15 cm



GERALD
C-313-17- C-314-17



GERALD
C-313-17
17 cm



GERALD
C-314-17
17 cm



POTTS-SMITH
C-315-15 15 cm
C-316-18 18 cm
C-317-20 20 cm



BONNEY
C-318-17 - C-319-17



BONNEY
C-318-17
17.5 cm



BONNEY
C-319-17
17.5 cm



CUSHING
C-320-17 - C-321-18
17.5 cm



C-320-17
17.5 cm



C-321-18
18 cm



CUSHING-TAYLOR
C-322-18
18 cm



OEHLER
C-323-14 14 cm
C-324-16 16 cm
C-325-18 18 cm
C-326-20 20 cm
C-327-25 25 cm
C-328-30 30 cm



**SECTION
C**

Tissue Forceps TC



TC GOLD



DE BAKEY
C-329-15
15 cm
C-330-20
20 cm
C-331-25
25 cm



DE BAKEY
C-332-15
15 cm
C-333-20
20 cm
C-334-25
25 cm



JABOMA-TC
C-335-18
18 cm



JABOMA-TC
C-336-18
18 cm



JABOMA-TC
C-337-18
18 cm

DE BAKEY
C-329-15 - C-334-25



OBWEGESER
C-338-16
16 cm



OBWEGESER
C-339-18
18 cm



MERIEM
C-340-00



POTTS-NEVINS
C-341-18
18 cm



BENELUX
s u r g i c a l

Page 74-114

SECTION

D

- Muller Vessel Clips And Bulldog Clamps
- Haemostatic Forceps
- Organ Grasping Forceps
- Dressing, Sponge Holding, Organ And Tissue Grasping Forceps
- Delicate Haemostatic Forceps
- Dissecting And Ligature Forceps
- Special Pattern, Tonsil Forceps
- Towel Clamps
- Tendon Seizing Forceps
- Vaginal Clamps And Compression Forceps
- Hysterectomy Forceps
- Peritoneum Forceps
- Tubing Clamps

Closing Force

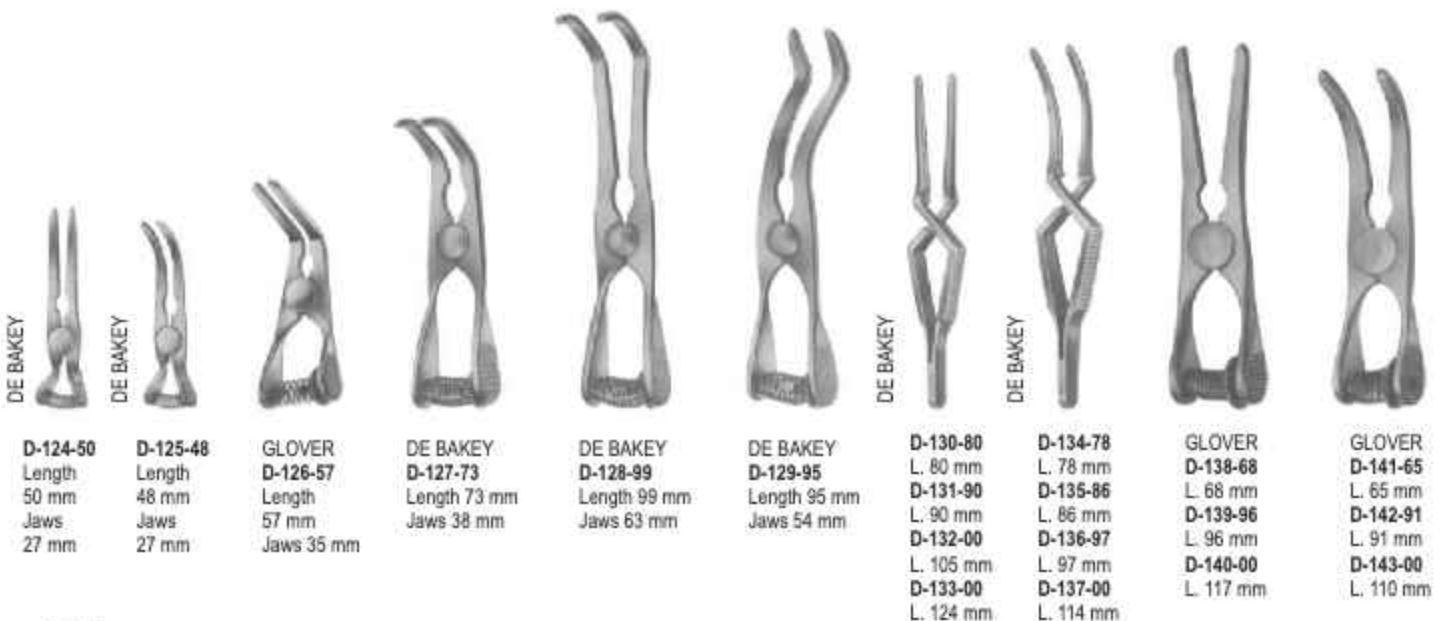
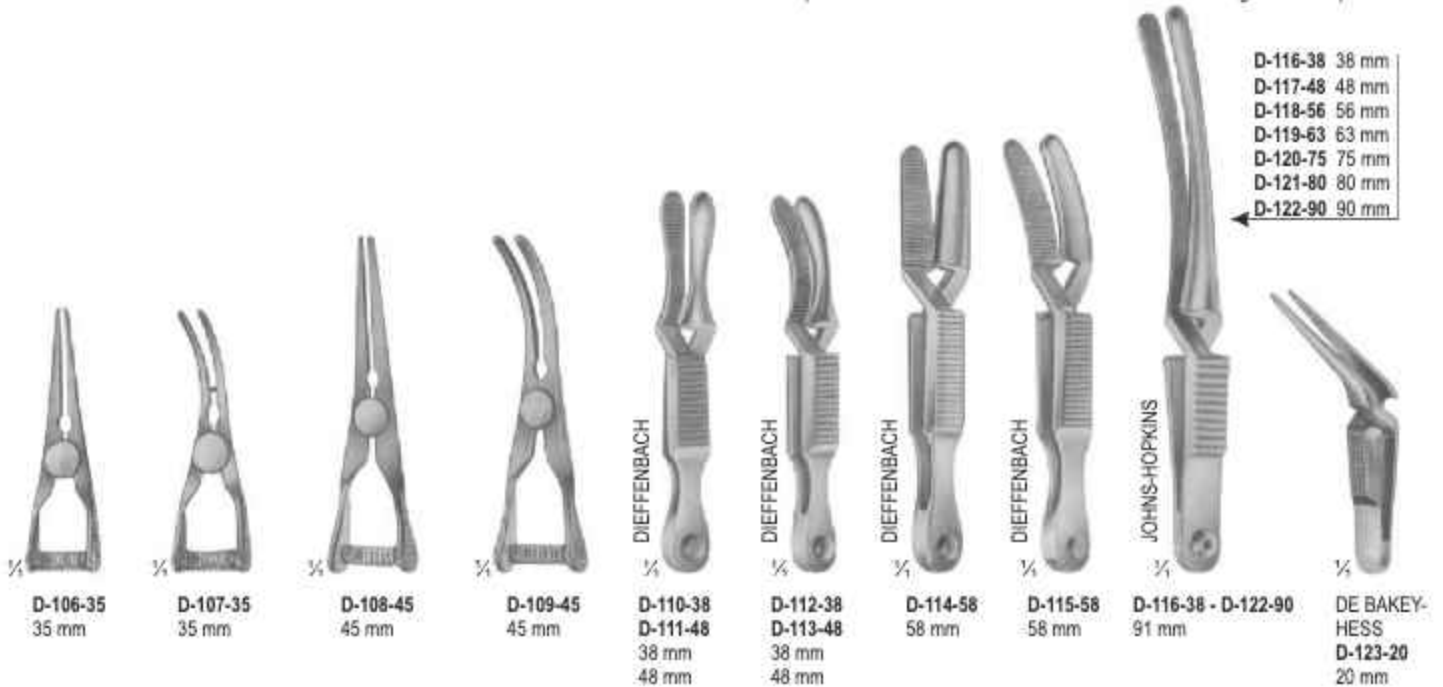
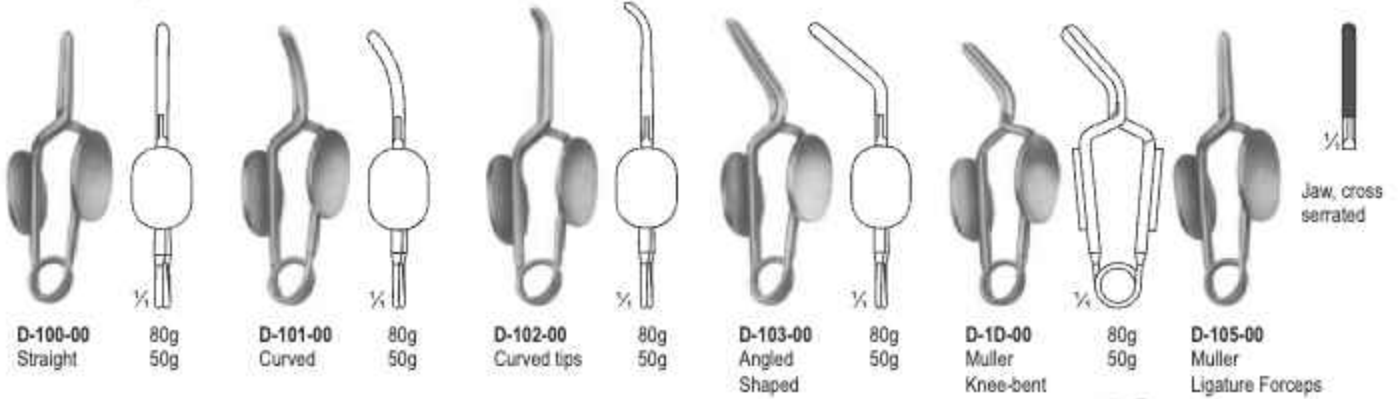

**SECTION
D**

Haemostatic Forceps



**BENELUX
surgical**



PEAN
D-144-16 16 cm
D-145-18 18 cm



PEAN
D-146-12 12.5 cm



PEAN
D-147-12 12.5 cm
D-148-14 14 cm



KRONLEIN
D-149-13 13 cm



1/4
Straight

SPENCER-WELLS
D-150-13 - D-156-30
D-150-13 13 cm
D-151-14 14 cm
D-152-15 15 cm
D-153-18 18 cm
D-154-20 20 cm
D-155-25 25 cm
D-156-30 30 cm

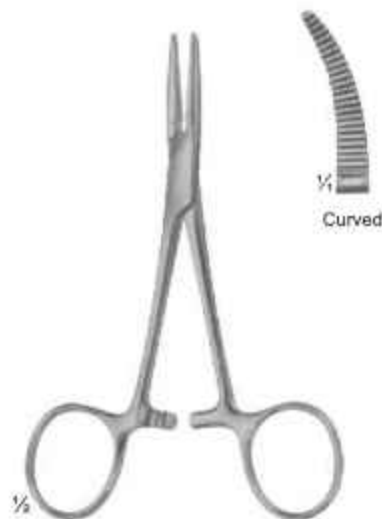

1/4
Curved

SPENCER-WELLS
D-157-13 - D-163-30
D-157-13 13 cm
D-158-14 14 cm
D-159-15 15 cm
D-160-18 18 cm
D-161-20 20 cm
D-162-25 25 cm
D-163-30 30 cm

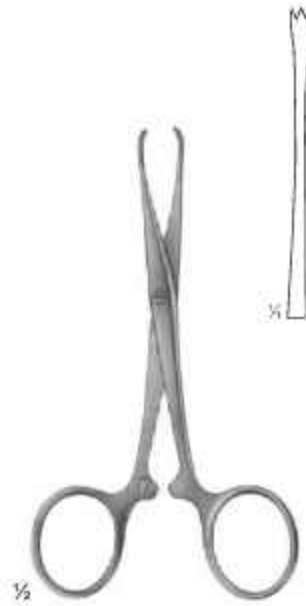

CHAPUT
D-164-12
2 X 3 teeth, sharp
12.5 cm



TUFFIER
D-165-12
5 X 6 teeth, sharp
12.5 cm

ATRAUMA



D-166-25 - D-167-27



D-166-25
25 cm



D-167-27
27 cm

**SECTION
D**

Dressing, Sponge Holding, Organ And Tissue Grasping Forceps

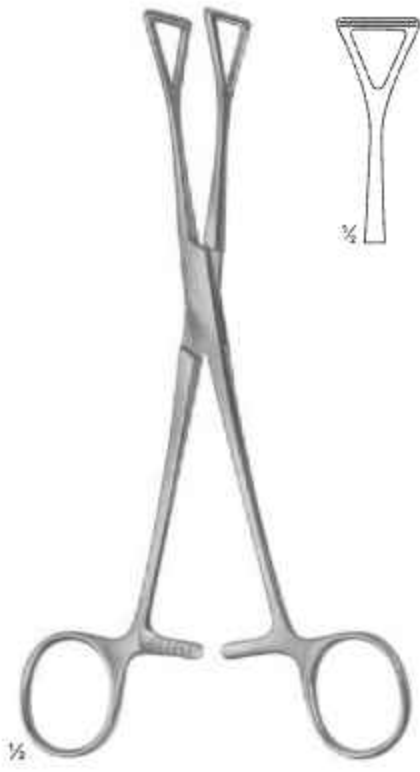

COLLIN
D-168-19 20 cm
D-169-23 23 cm



PRATT
D-170-15 15 cm



MARTEL-REES
D-171-13 13.5 cm

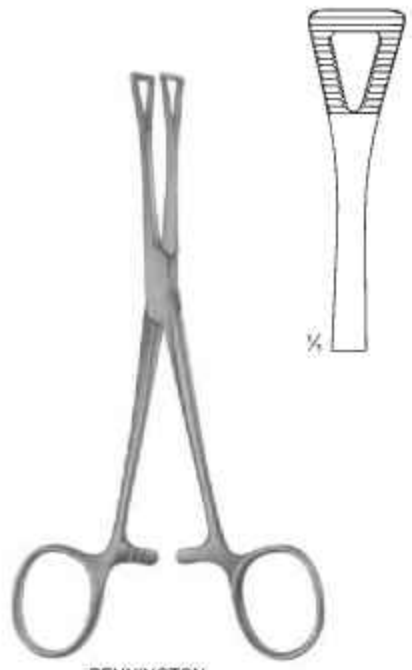

PENNINGTON
D-172-15 15.5 cm
D-173-21 21 cm

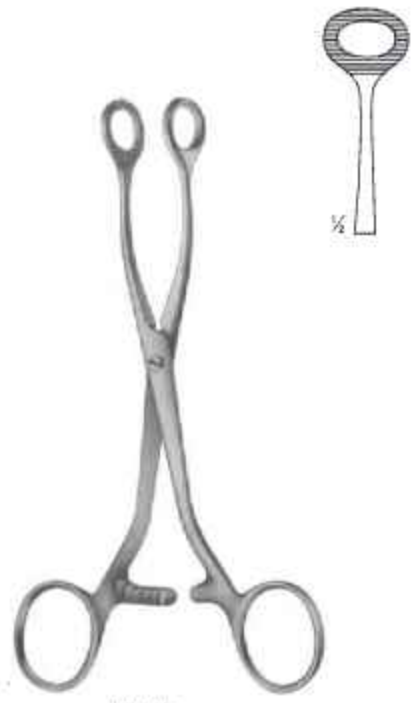

COLLIN
D-174-16 16 cm
D-175-17 17 cm



CARREL
D-176-08
8,5 cm



BABY-MOSQUITO
(HARTMANN)
D-177-10 - D-178-10
10 cm



BABY-MOSQUITO
(HARTMANN)
D-179-10 - D-180-10
10 cm



MICRO-HALSTED
D-181-12 12,5 cm
D-182-14 14 cm



MICRO-HALSTED
D-183-12 12,5 cm
D-184-14 14 cm



HALSTED-MOSQUITO
D-185-12 12,5 cm
D-186-14 14 cm



HALSTED-MOSQUITO
D-187-12 12,5 cm
D-188-14 14 cm

**SECTION
D**

Delicate- and Ligature Forceps



MICRO-ADSON
D-189-12 12 cm
D-190-14 14 cm



BABY-ADSON
D-191-12 12 cm
D-192-14 14 cm

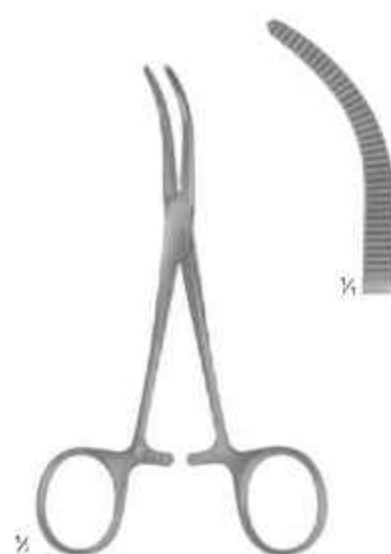

BABY-OVERHOLT
D-193-13
13 cm



BABY-MIXTER
D-194-13
13 cm

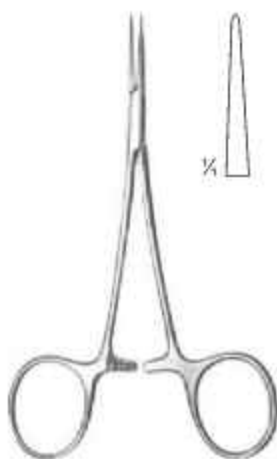

LIGTURE-FORCEP
D-195-12
12.5 cm



LIGTURE-FORCEP
D-196-12
12.5 cm



OVERHOLT-MINI
D-197-15
15 cm

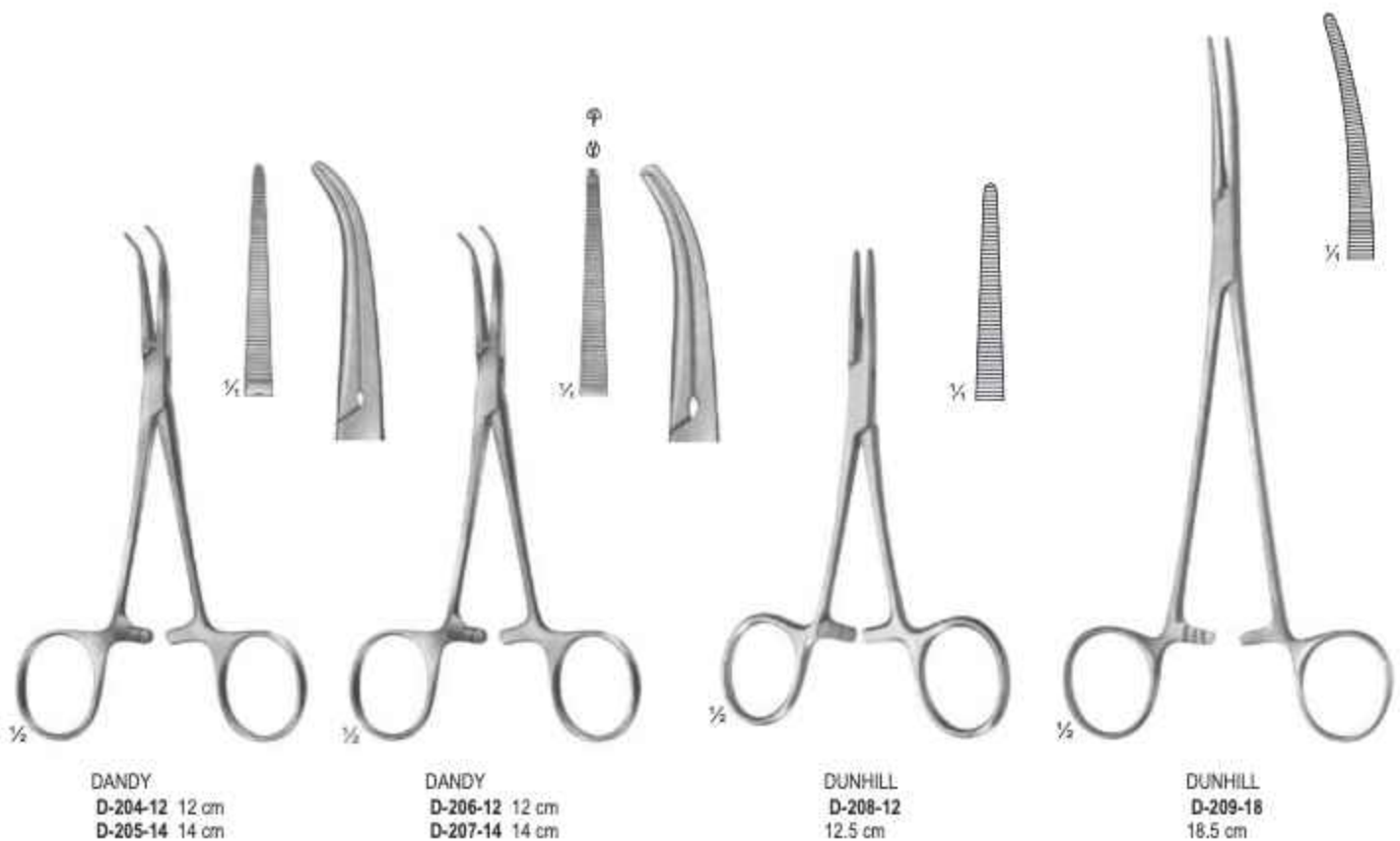
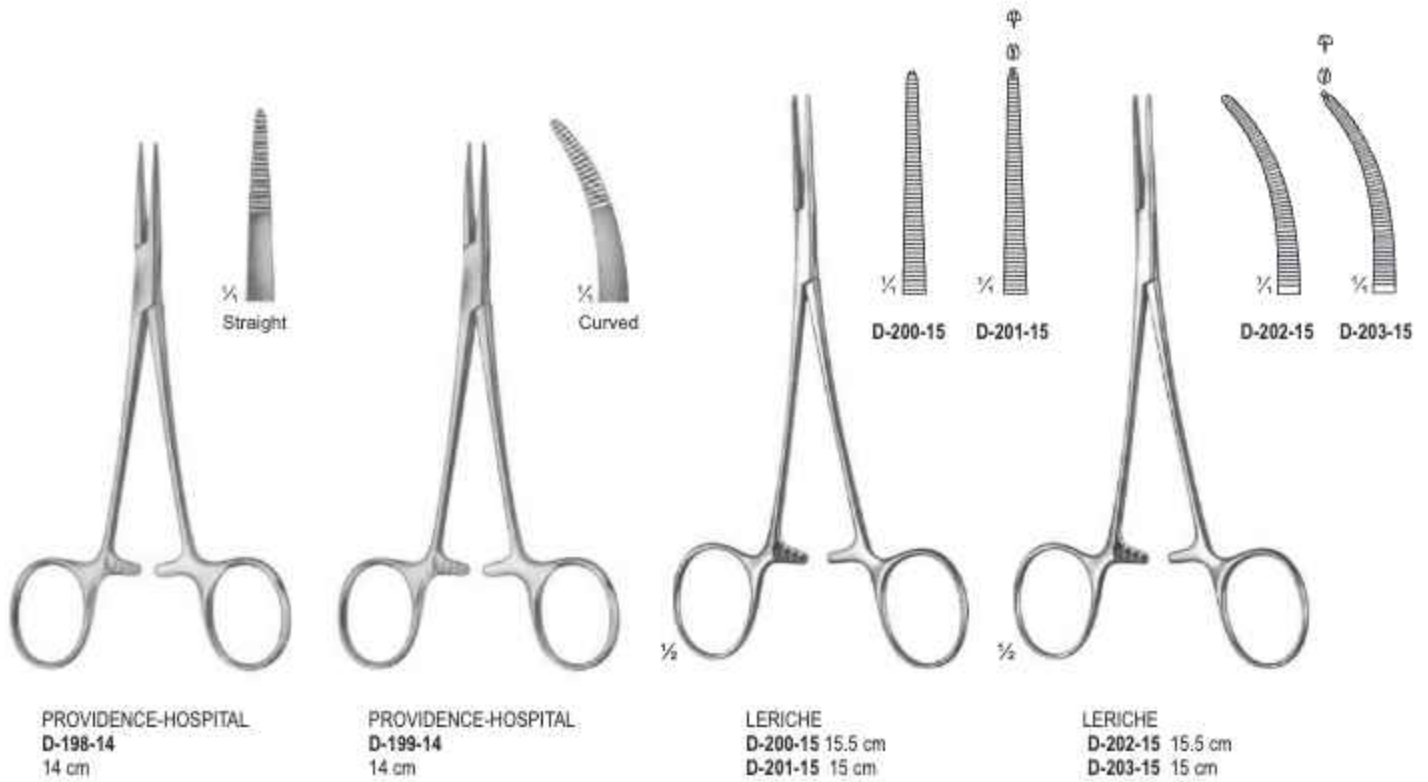

**SECTION
D**

Delicate Haemostatic Forceps

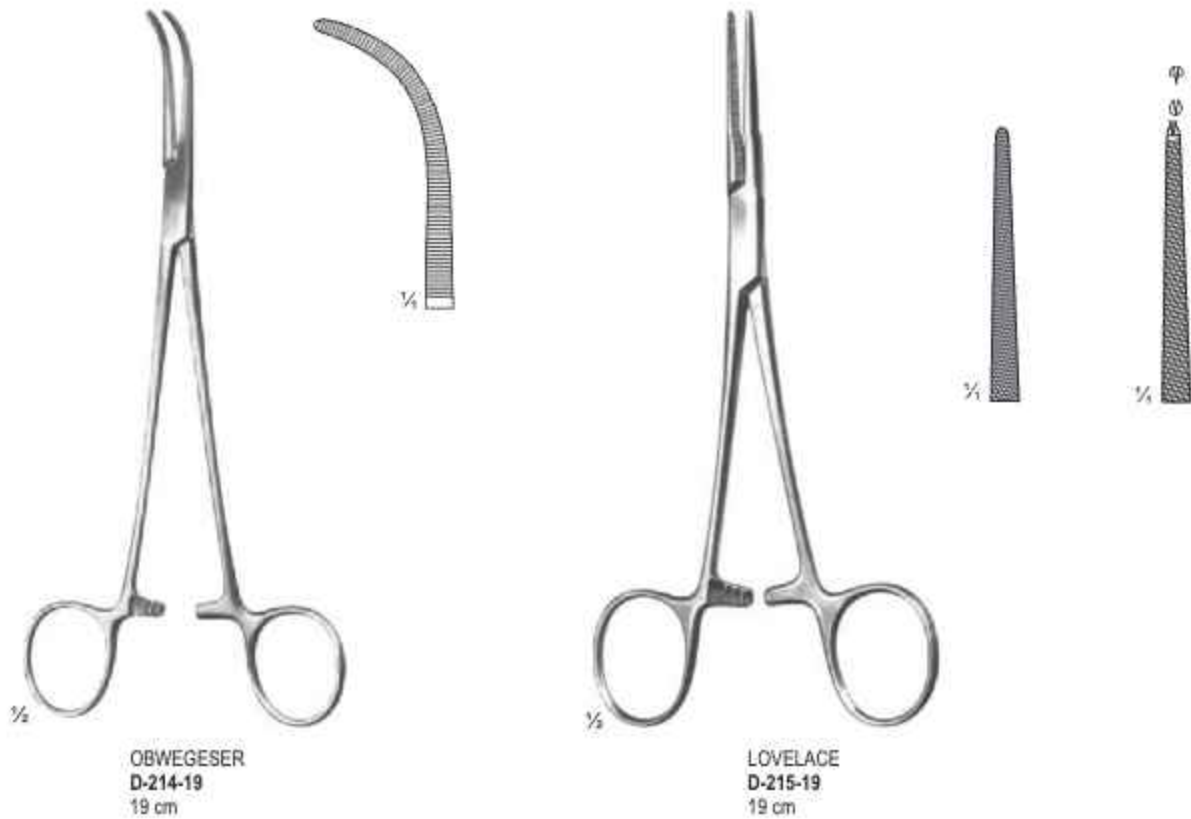
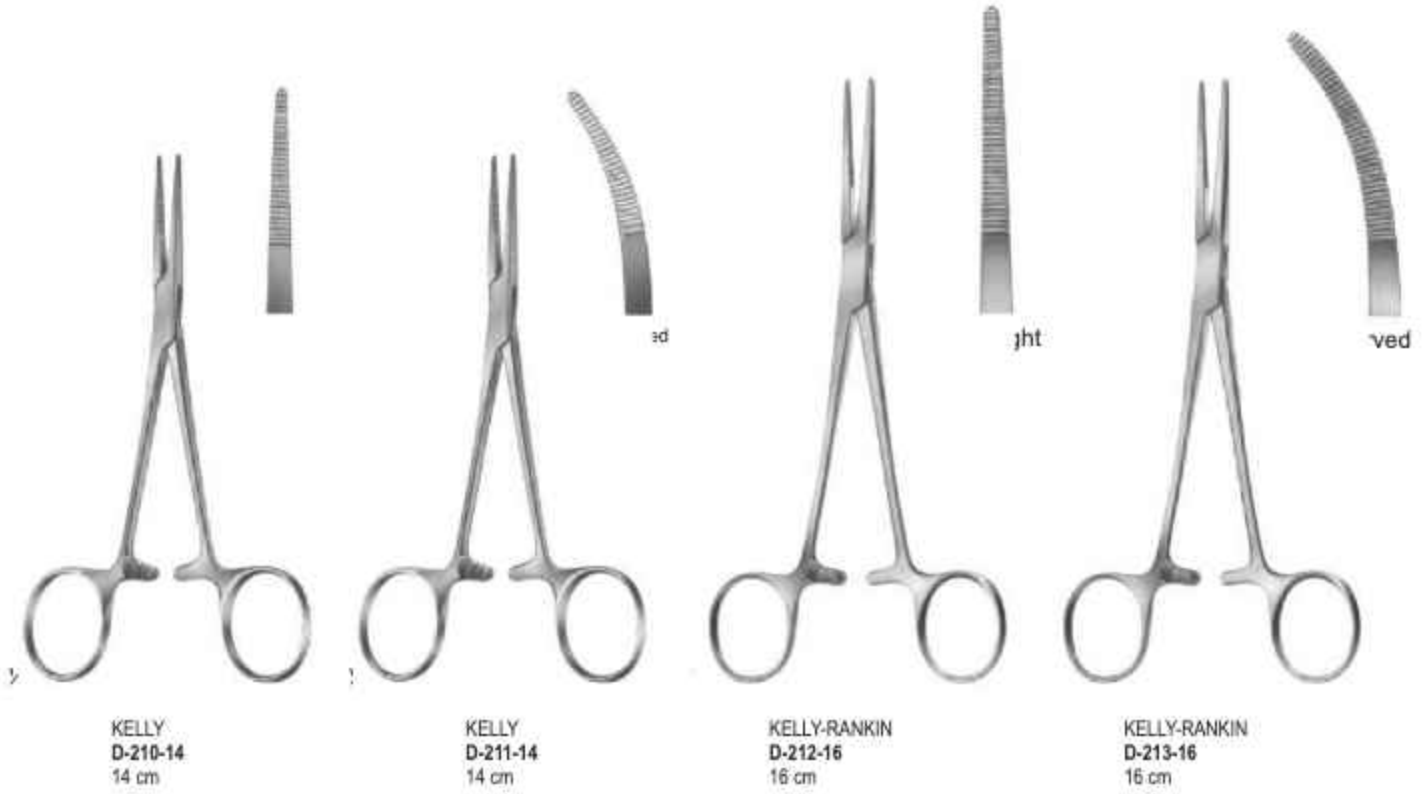

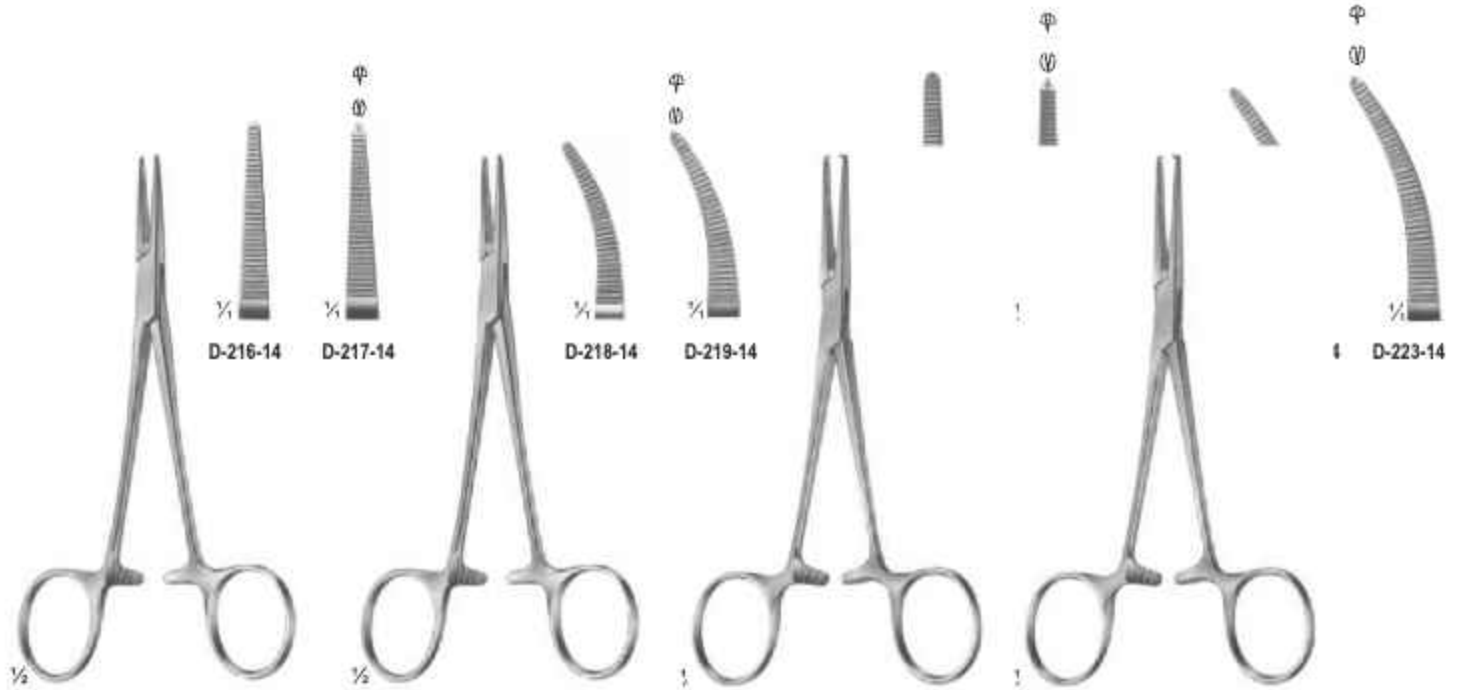

BABY-CRILE
D-216-14 - D-217-14
14 cm

BABY-CRILE
D-218-14 - D-219-14
14 cm

CRILE
D-220-14 - D-221-14
14 cm

CRILE
D-222-14 - D-223-14
14 cm

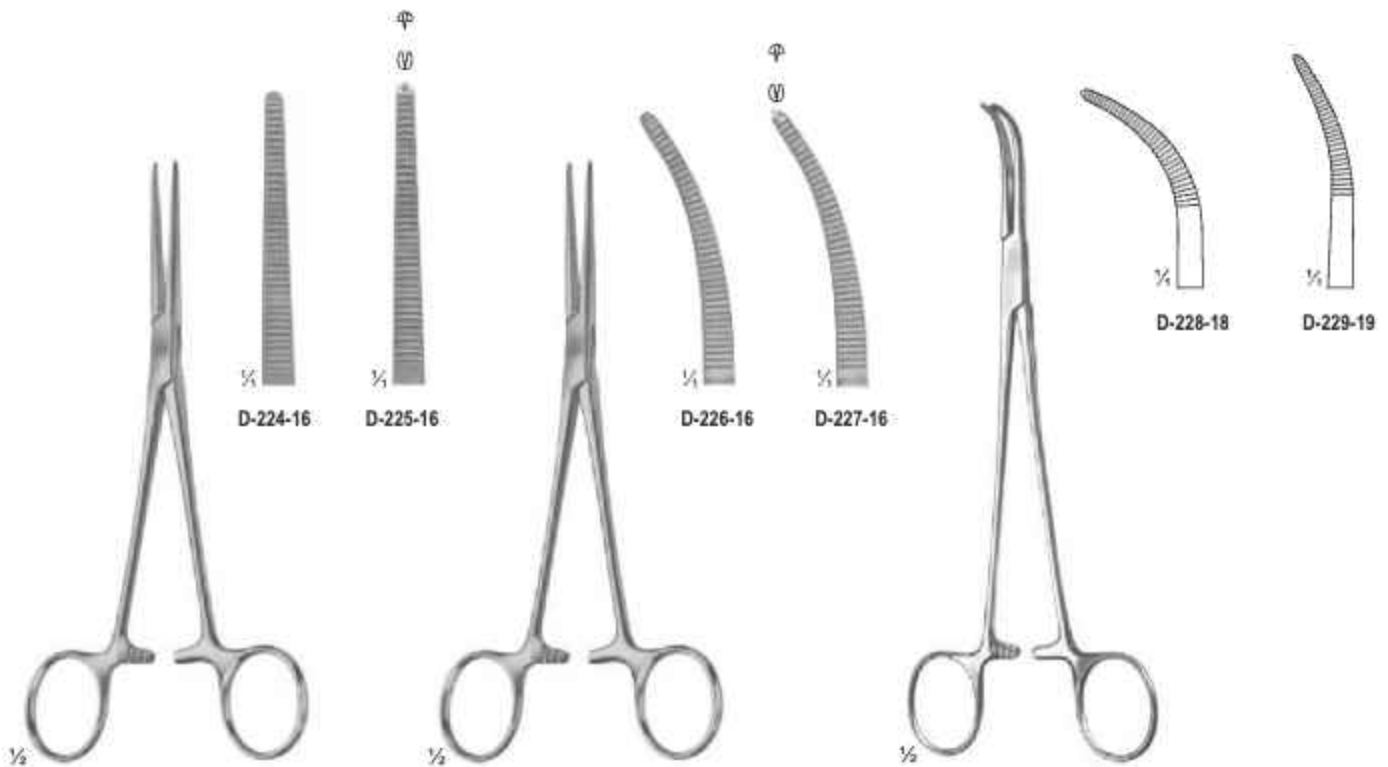

CRILE-RANKIN
D-224-16 - D-225-16
16 cm

CRILE-RANKIN
D-226-16 - D-227-16
16 cm

SCHNIDT
D-228-18 18 cm
D-229-19 19 cm

**SECTION
D**

Delicate Haemostatic Forceps



D-230-16 16 cm
D-231-21 21 cm



D-232-16 16 cm
D-233-21 21 cm



HALSTED
D-234-21 - D-235-21
21.5 cm



MARTIN-FUCHSIG
D-236-20
20 cm



ROCHESTER-CARMALT
D-237-17 17 cm
D-238-20 20 cm



ROCHESTER-CARMALT
D-239-16 16 cm
D-240-20 20 cm





BENGOLEA
D-241-20 - D-244-26



1/4
Straight
D-241-20
20 cm
D-242-26
26 cm



1/4
Straight
D-243-20
20 cm
D-244-26
26 cm



BENGOLEA
D-245-20 - D-248-26



1/4
Curved
D-245-20
20 cm
D-246-26
26 cm



1/4
Curved
D-247-20
20 cm
D-248-26
26 cm

**SECTION
D**

Haemostatic Forceps

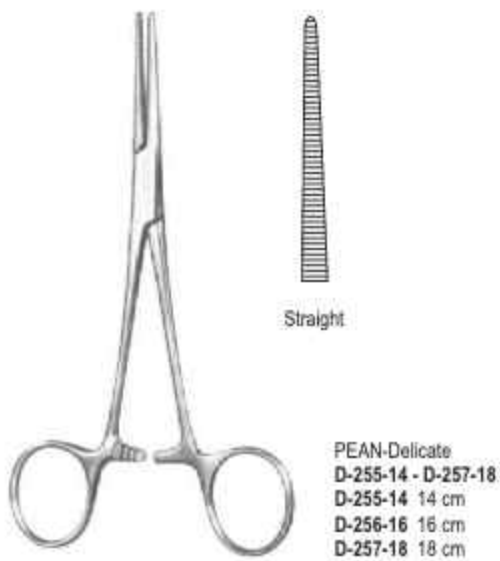
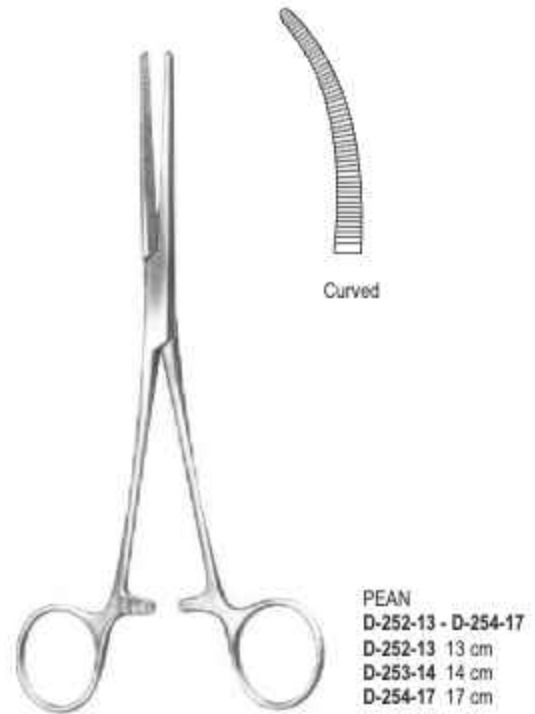
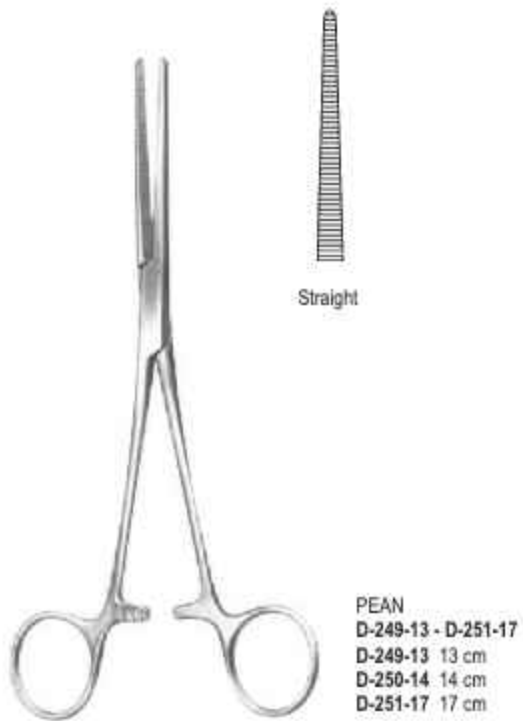

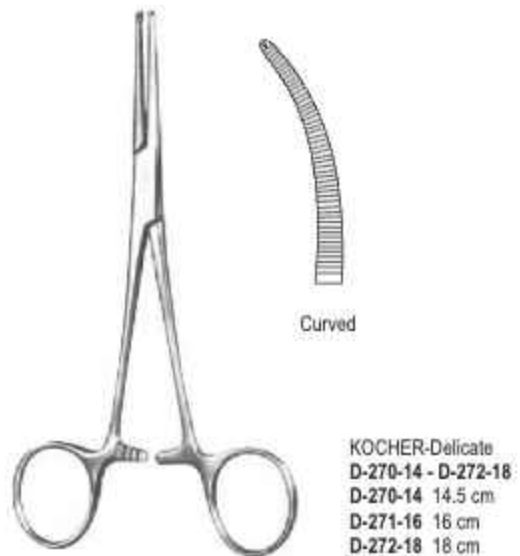
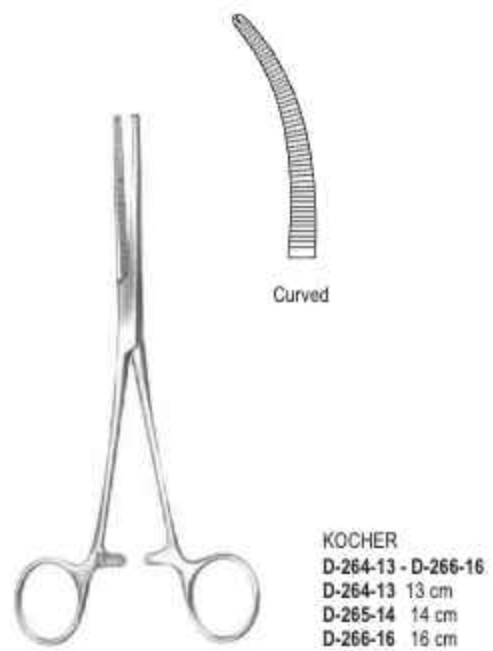
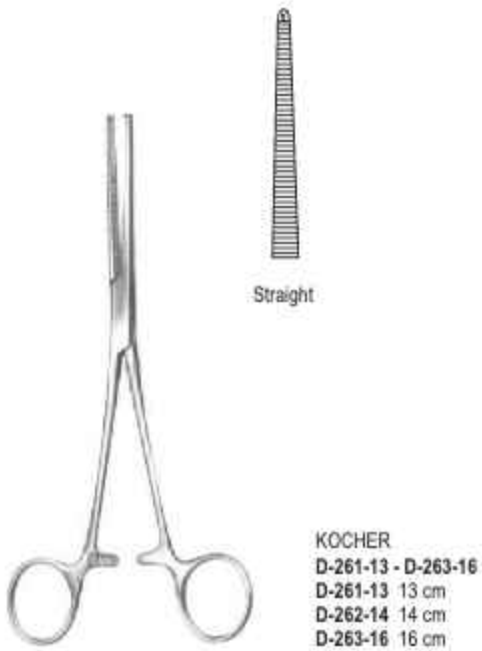

**SECTION
D**

Haemostatic Forceps



Straight

PEAN (ROCHESTER)
D-273-14 - D-280-30
 D-273-14 14 cm
 D-274-16 16 cm
 D-275-18 18 cm
 D-276-20 20 cm
 D-277-22 22 cm
 D-278-24 24 cm
 D-279-26 26 cm
 D-280-30 30 cm

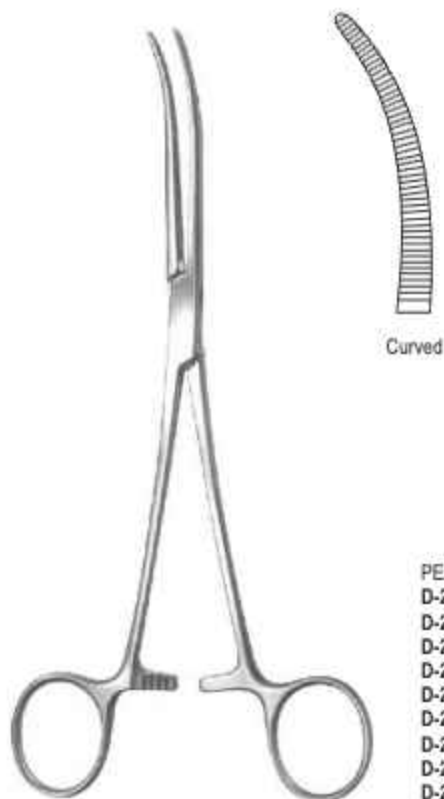

Curved

PEAN (ROCHESTER)
D-281-14 - D-288-30
 D-281-14 14 cm
 D-282-16 16 cm
 D-283-18 18 cm
 D-284-20 20 cm
 D-285-22 22 cm
 D-286-24 24 cm
 D-287-26 26 cm
 D-288-30 30 cm



Straight

KOCHER (OCHSNER)
D-289-14 - D-296-31
 D-289-14 14 cm
 D-290-16 16 cm
 D-291-18 18 cm
 D-292-20 20 cm
 D-293-22 22 cm
 D-294-24 24 cm
 D-295-26 26 cm
 D-296-31 31 cm

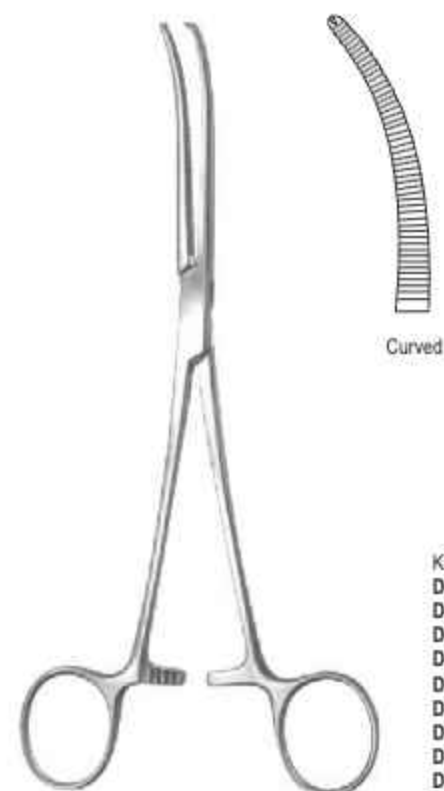

Curved

KOCHER (OCHSNER)
D-297-14 - D-304-31
 D-297-14 14 cm
 D-298-16 16 cm
 D-299-18 18 cm
 D-300-20 20 cm
 D-301-22 22 cm
 D-302-24 24 cm
 D-303-26 26 cm
 D-304-31 31 cm



1/4
Straight

1/2
ADSON
D-305-18
18.5 cm



1/4
Curved

1/2
ADSON
D-306-19
19 cm

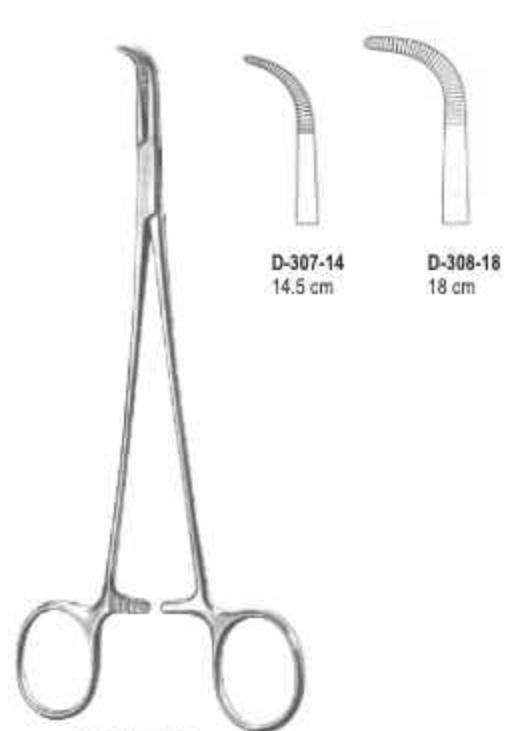

D-307-14
14.5 cm

D-308-18
18 cm

ADSON (BABY)
D-307-14 - D-308-18



1/4
D-309-20

1/4
D-310-20

1/4
D-311-20

1/4
D-312-20

1/4
D-313-20

HEISS
D-309-20 - D-313-20
20 cm



1/4

1/2
HEISS
D-314-19
19.5 cm

**SECTION
D**

Haemostatic Forceps



**BENELUX
surgical**



OVERHOLT-MARTIN
D-315-18 - D-319-24



Fig. 1
D-315-18
18.5 cm



Fig. 2
D-316-20
20.5 cm



Fig. 3
D-317-21
21 cm



Fig. 4
D-318-24
21.5 cm



Fig. 5
D-319-24
24.5 cm



MIXTER-BABY
D-320-18
18.5 cm



OVERHOLT-MIXTER
D-321-18
18.5 cm



OVERHOLT-MIXTER
D-322-20
20.5 cm



MIXTER-O'SHAUGNESSY
D-323-19
19 cm



MIXTER
D-324-16 - D-325-17



D-324-16
16 cm

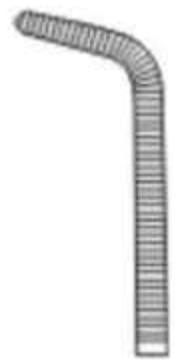

D-325-17
17.5 cm

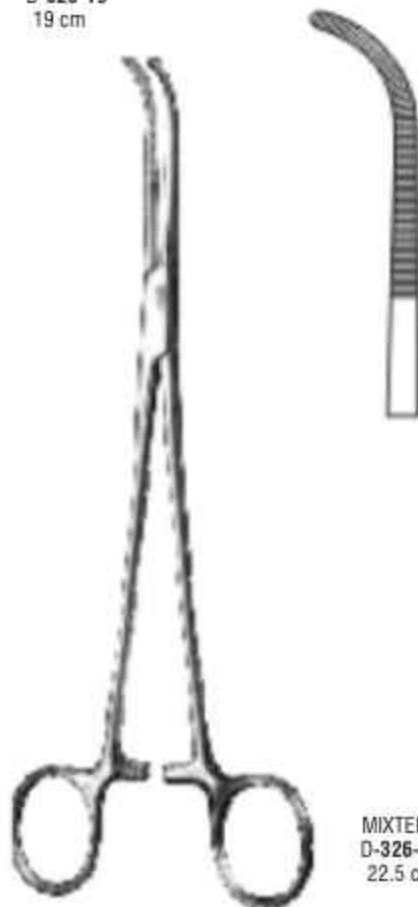

MIXTER
D-326-22
22.5 cm



MIXTER
D-327-23
23 cm

**SECTION
D**

Haemostatic Forceps



MIXTER
D-328-22 - D-330-28



D-328-22
22.5 cm



D-329-26
26 cm



D-330-28
28 cm



½

MIXTER
D-331-22 - D-332-25
D-331-22 22 cm
D-332-25 25 cm



¼



MCQUIGG-MIXTER
D-333-23
23.5 cm



MINI-GEMINI
D-334-18 - D-337-28



D-334-18
18 cm



D-335-23
23 cm



D-336-25
25 cm



D-337-28
28 cm



OVERHOLT-MINI
D-338-20
20 cm



GEMINI
D-339-13 - D-345-28



D-339-13
13 cm



D-340-13
16 cm



D-341-18
18 cm

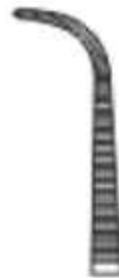

D-342-21
21 cm

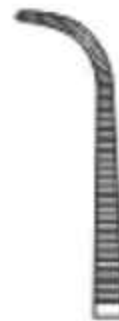

D-343-23
23 cm



D-344-25
25 cm



D-345-28
28 cm

**SECTION
D**

Dissecting- And Ligature Forceps

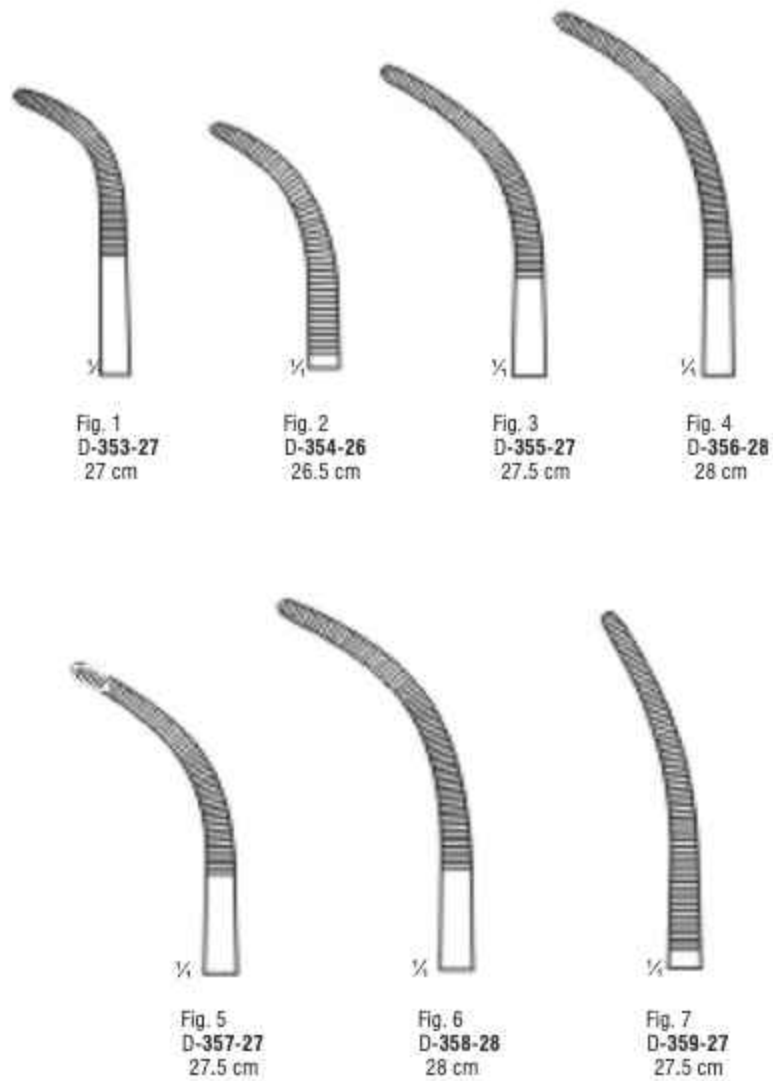
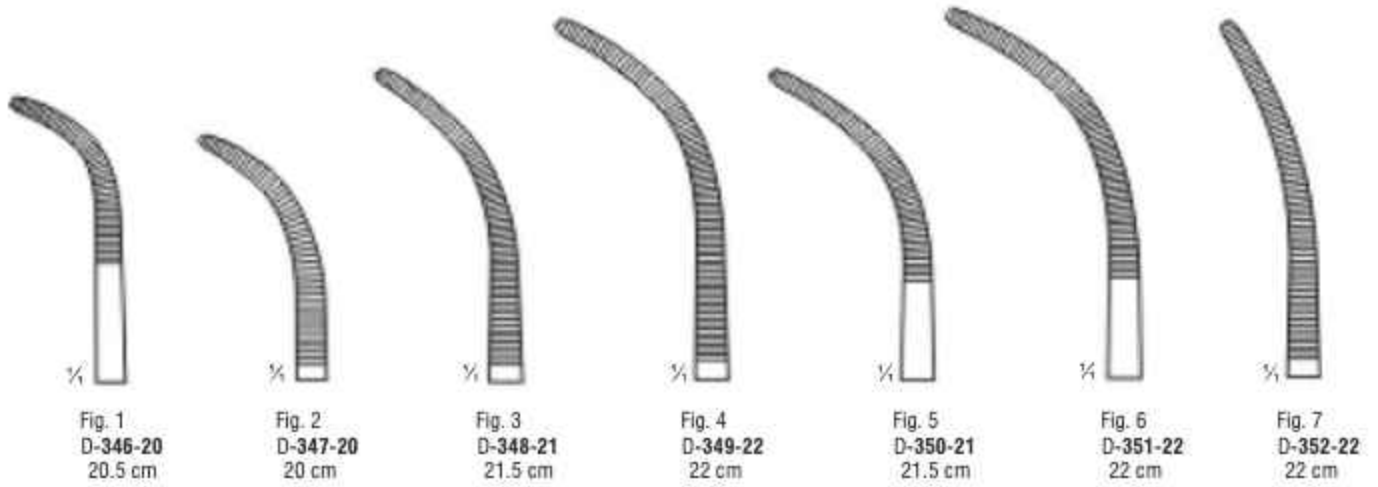



OVERHOLT
D-360-29 - D-362-30

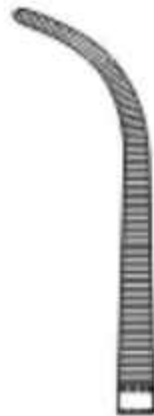

D-360-29
29.5 cm

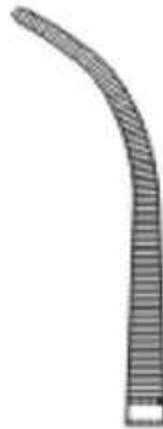

D-361-29
29.5 cm



D-362-30
30 cm



OVERHOLT-DELICATE
D-363-21 - D-367-22

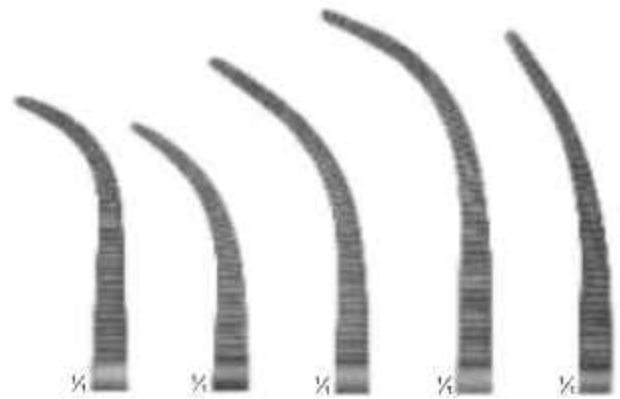

Fig. 0
D-363-21
21.5 cm

Fig. 1
D-364-22
22 cm

Fig. 2
D-365-22
22.5 cm

Fig. 3
D-366-23
23 cm

Fig. 6
D-367-22
22.5 cm

**SECTION
D**

Haemostatic Forceps, Special Pattern, Tonsil Forceps



**BENELUX
surgical**



CRAFOORD
D-368-18 - D-369-24



D-368-18
18 cm



D-369-24
24 cm



D-372-24



D-371-24



D-370-24



CRAFOORD-SELLORS
D-370-24 - D-372-24
24 cm

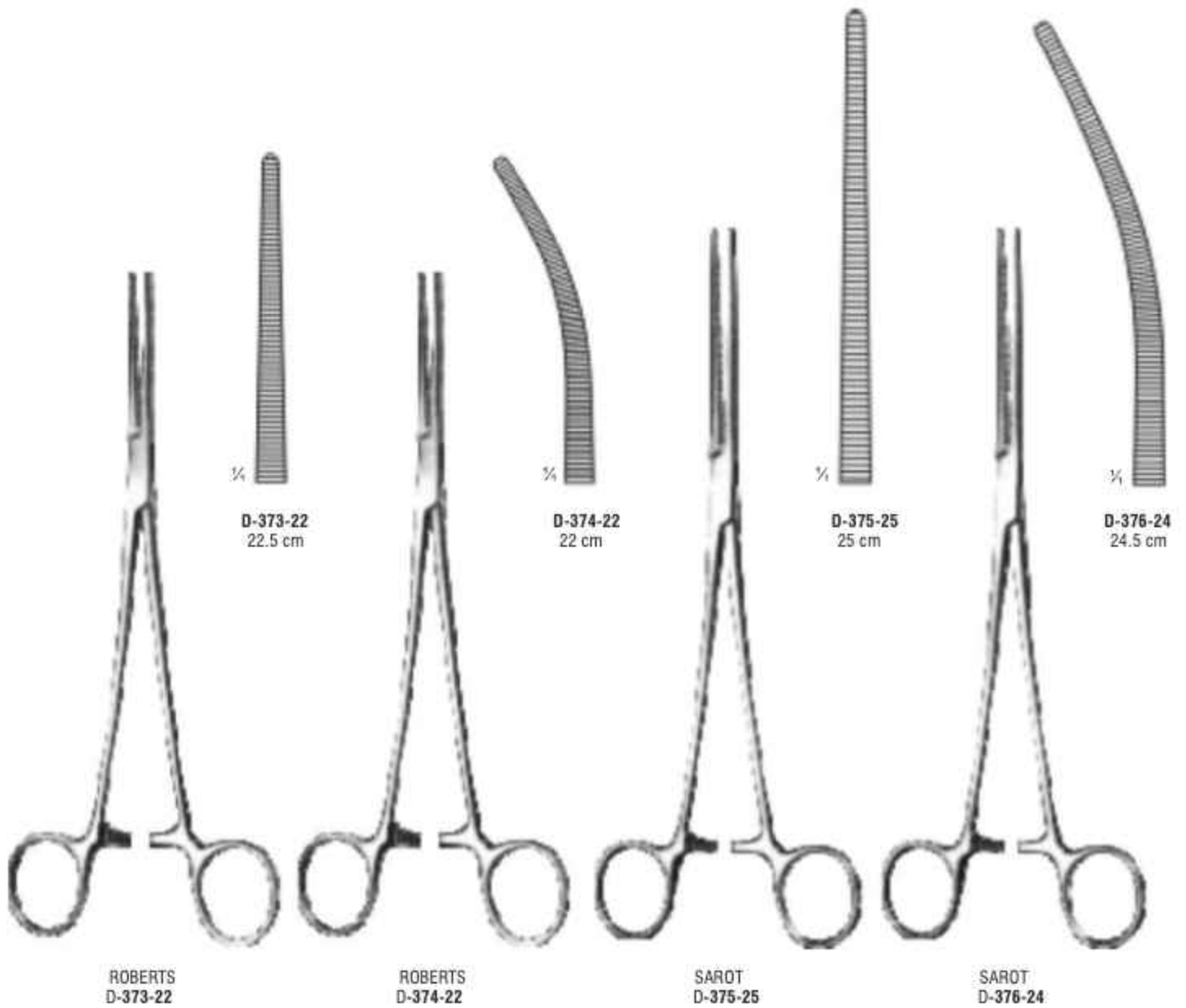

**SECTION
D**

Dissecting- And Ligature Forceps



**BENELUX
surgical**



RUMEL
D-377-24 - D-381-24
24 cm



D-377-24



D-378-24



D-379-24



D-380-24



D-381-24



ZENKER
D-382-30 - D-383-29
D-382-30 30 cm
D-383-29 29 cm



D-382-30



LAWRENCE
D-384-27
27 cm



D-384-27



NEGUS
D-385-19 - D-386-19
19 cm



D-385-19



D-386-19



MEEKER
D-387-28
28 cm



KELLY
D-388-19 - D-396-23



Fig. 1
D-388-19
19 cm



Fig. 1
D-389-22
22.5 cm

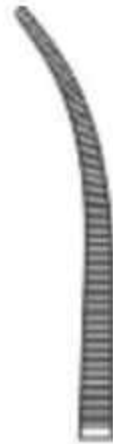

Fig. 1
D-390-24
24 cm



Fig. 2
D-391-19
19 cm



Fig. 2
D-392-22
22 cm

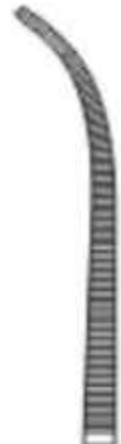

Fig. 2
D-393-23
23.5 cm



Fig. 3
D-394-18
18.5 cm



Fig. 3
D-395-21
21.5 cm

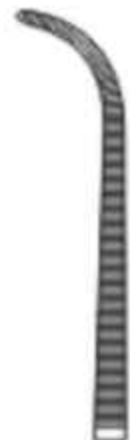

Fig. 3
D-396-23
23.5 cm

**SECTION
D**

Dissecting- And Ligature Forceps



FINOCHIETTO
D-397-24
24.5 cm



FINOCHIETTO
D-398-24
24.5 cm



LAHEY (SWEET)
D-399-19 - D-400-23
D-399-19 19 cm
D-400-23 23 cm



DESJARDINS
D-401-21
21 cm



LOWER
D-402-18
18 cm



NISSEN
D-403-18
18 cm

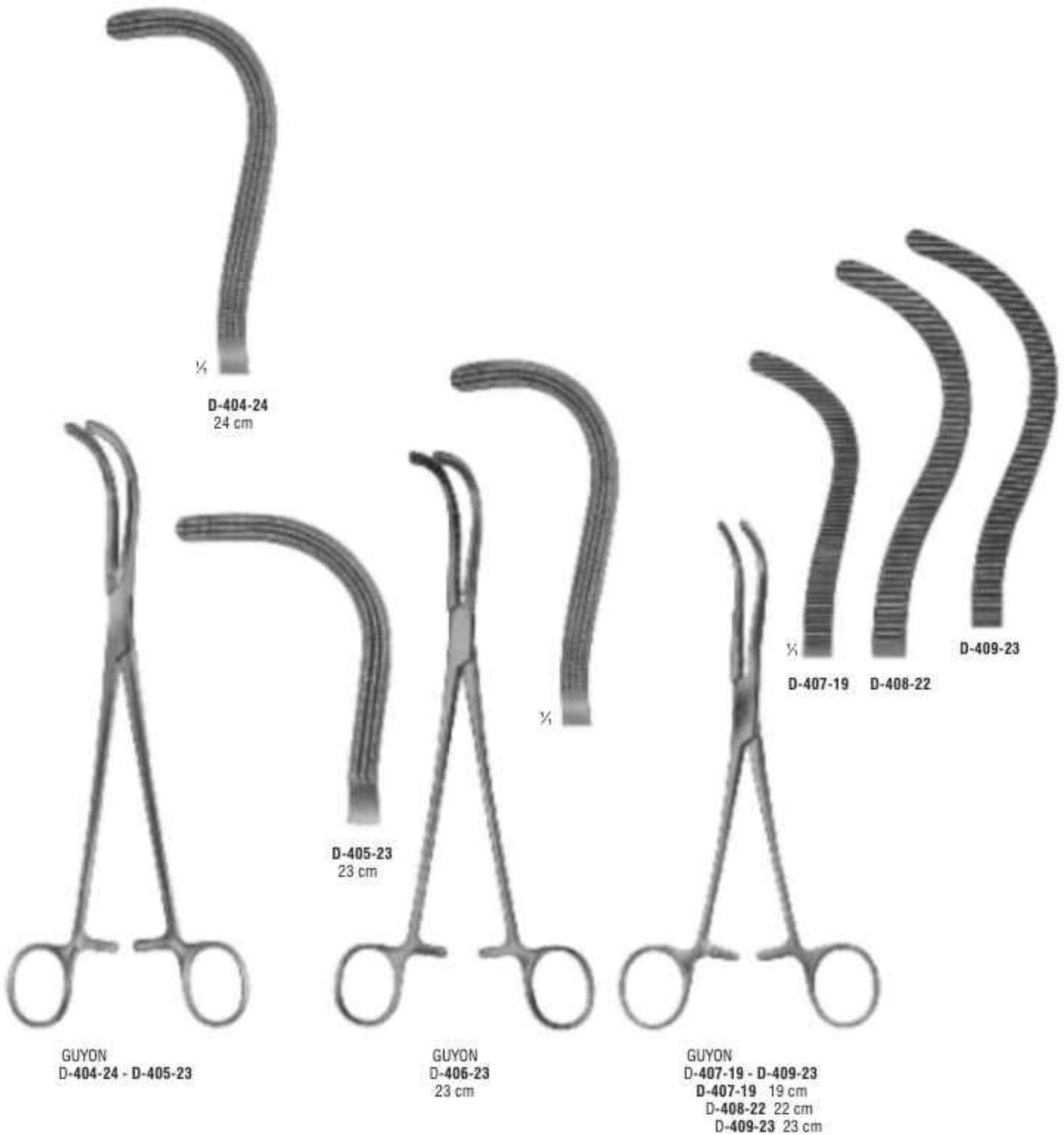

SECTION
D

Haemostatic Forceps, Special Pattern, Tonsil Forceps

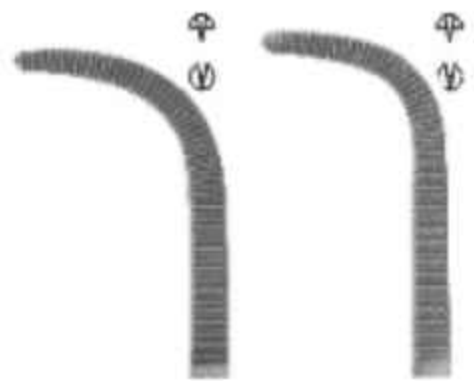
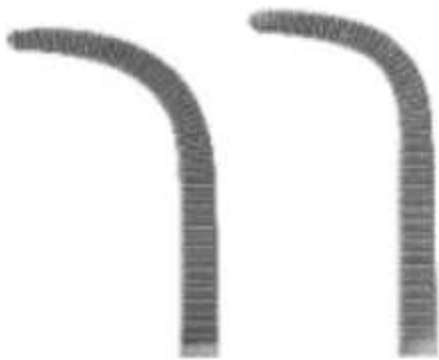

22



D-416-23
23 cm

D-417-24
24 cm

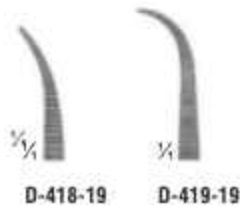

YASARGIL
D-418-19 - D-419-19
19.5 cm



STILLE
D-420-22
22 cm



HERRICK
D-421-22
22.5 cm

**SECTION
D**

Towel Clamps



ROBIN
with holders for tubing
up to 13 mm
D-422-13
13.5 cm



D-423-11
with clip for tubing
up to 15 mm
11 cm



LORNA
non perforating
D-424-13
13 cm



for paper cloths
D-425-14
14 cm



BUNT
D-426-10
10.5 cm



MAYO
D-427-14
14 cm

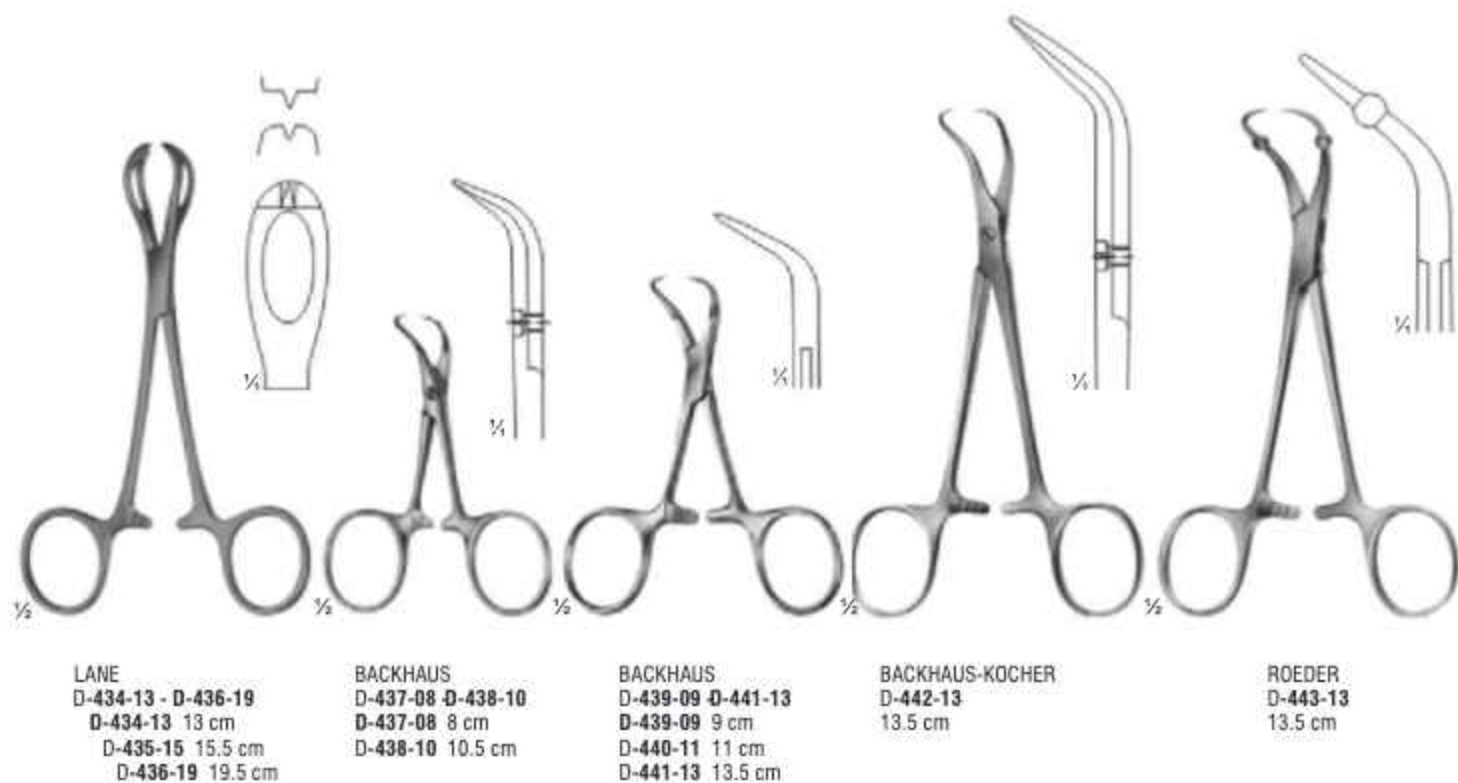
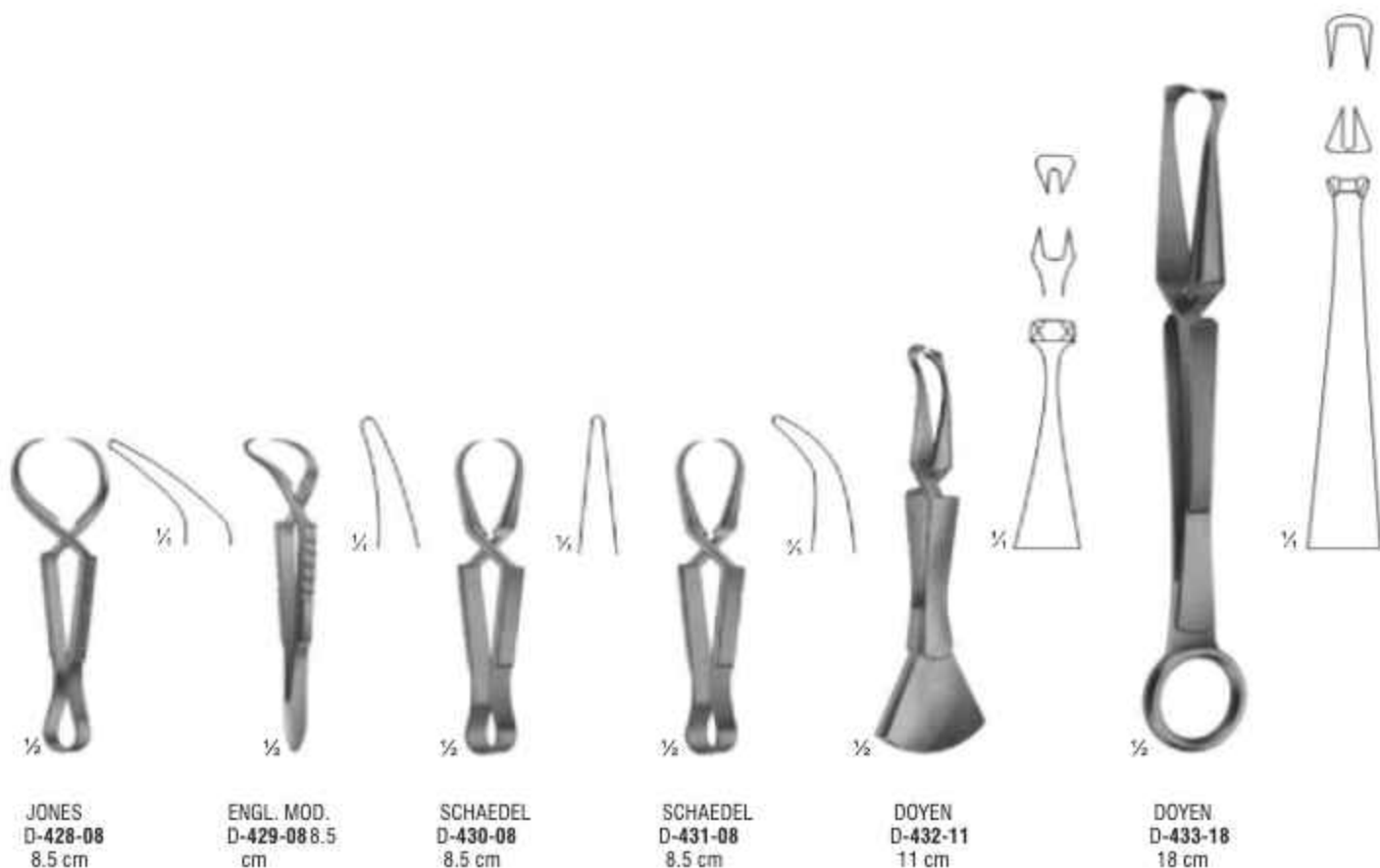

**SECTION
D**

Tendon Seizing Forceps



HERZ
D-444-15 D-445-15
15.5 cm



D-444-15



D-445-15



JACKSON
4 x 5 teeth
D-446-15
15 cm

D-446-15

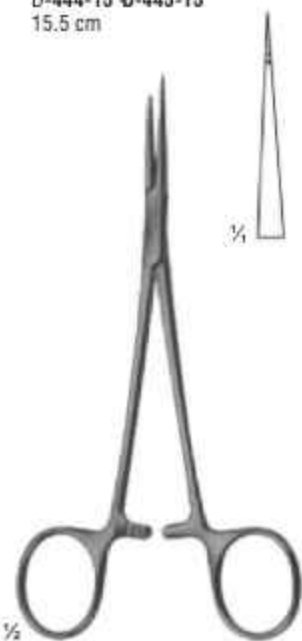

D-447-15
15 cm



D-448-15
15 cm

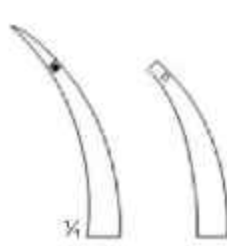

D-449-12
12 cm

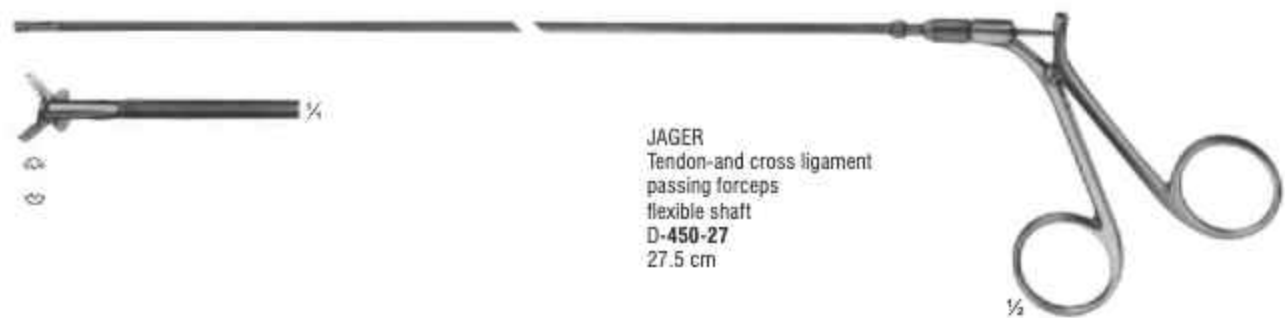

JAGER
Tendon-and cross ligament
passing forceps
flexible shaft
D-450-27
27.5 cm



WERTHEIM
Hysterectomy Forceps
D-451-25
25.5 cm

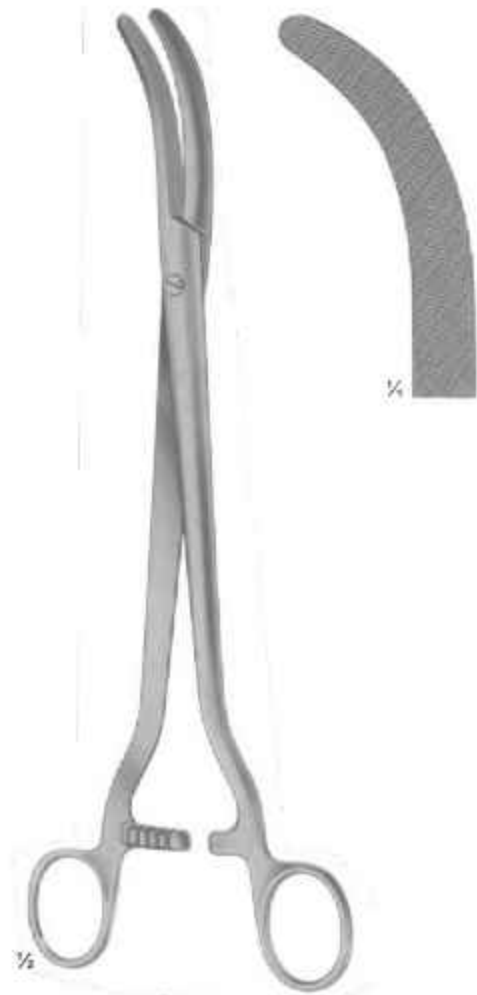

WERTHEIM
Parametrium Clamp
D-452-26
26 cm



WERTHEIM
D-453-22
22.5 cm

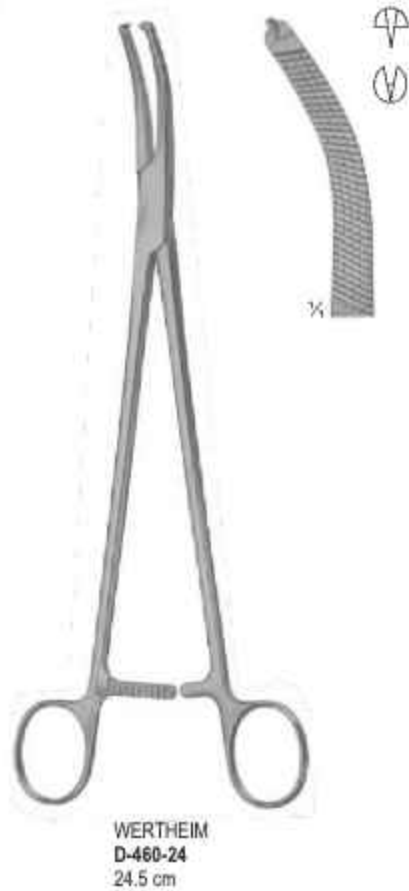

**SECTION
D**

Hysterectomy Forceps And Vaginal Clamps

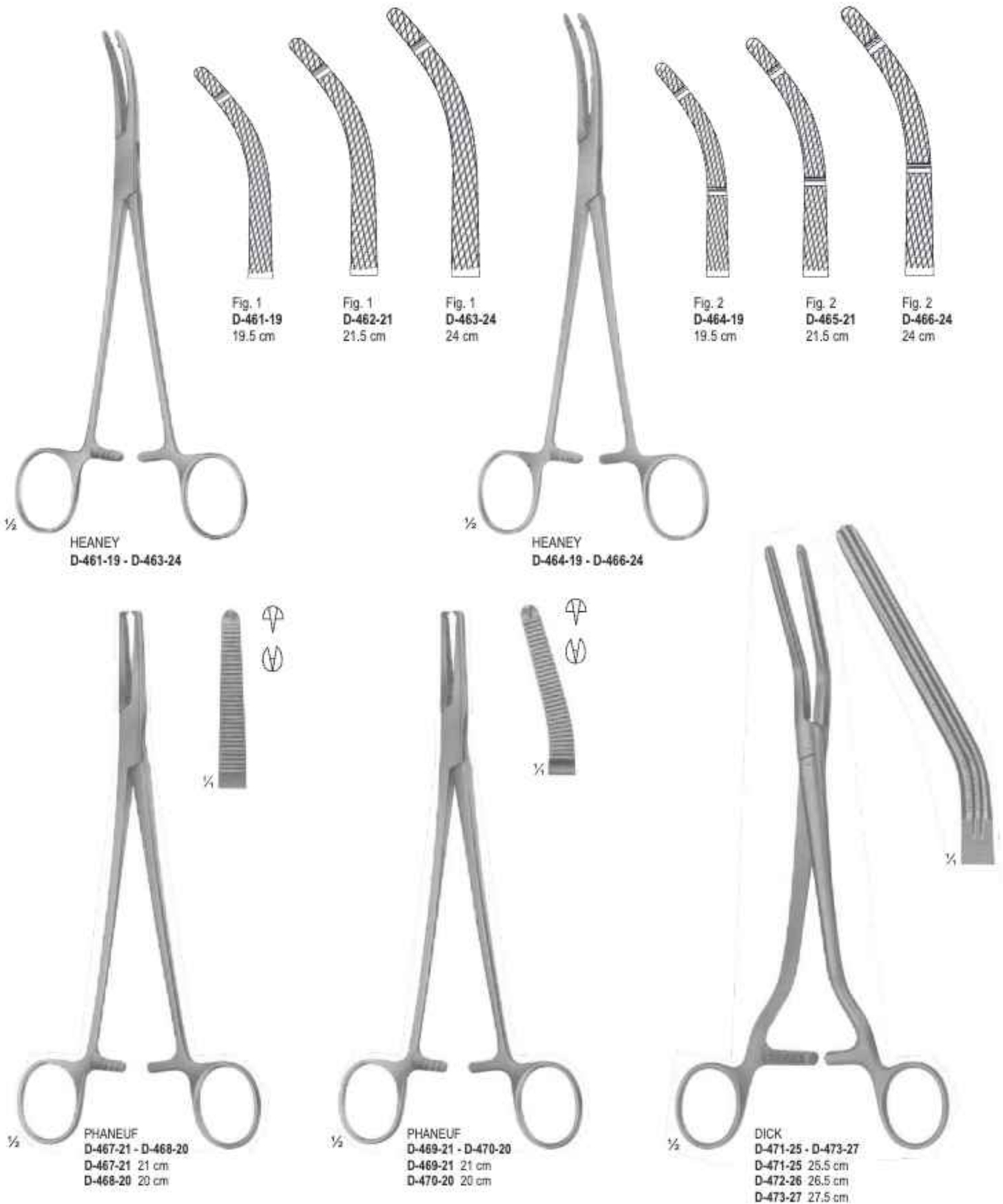



ROGERS
D-474-21 - D-477-20



Fig. 1
D-474-21
21.5 cm



Fig. 2
D-475-21
21 cm



Fig. 3
D-476-21
21.5 cm



Fig. 4
D-477-20
20.5 cm



ROGERS
D-478-25 - D-480-24



Fig. 1
D-478-25
25.5 cm



Fig. 2
D-479-25
25 cm



Fig. 3
D-480-24
24.5 cm

**SECTION
D**

Peritoneum Forceps



**BENELUX
surgical**

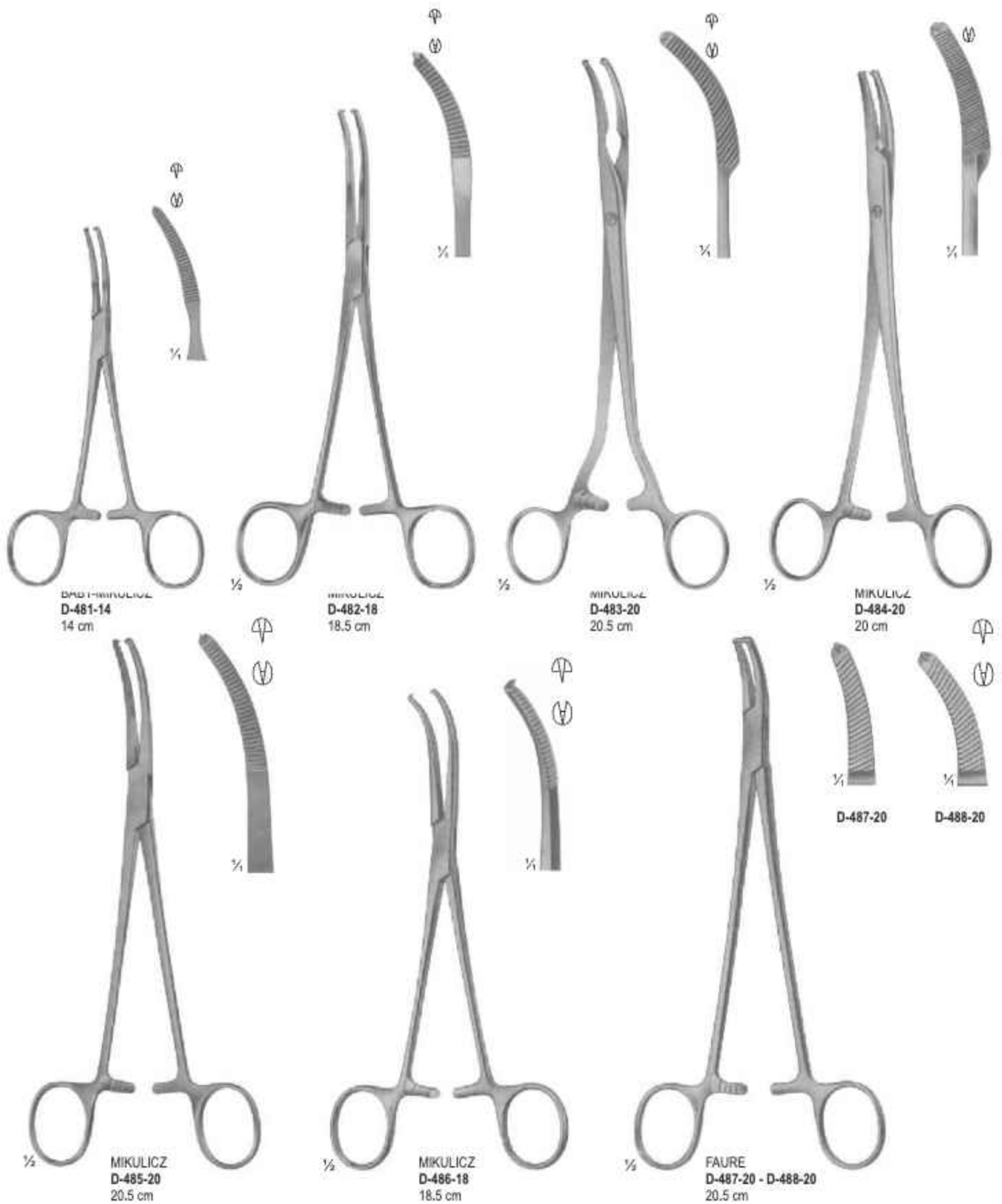

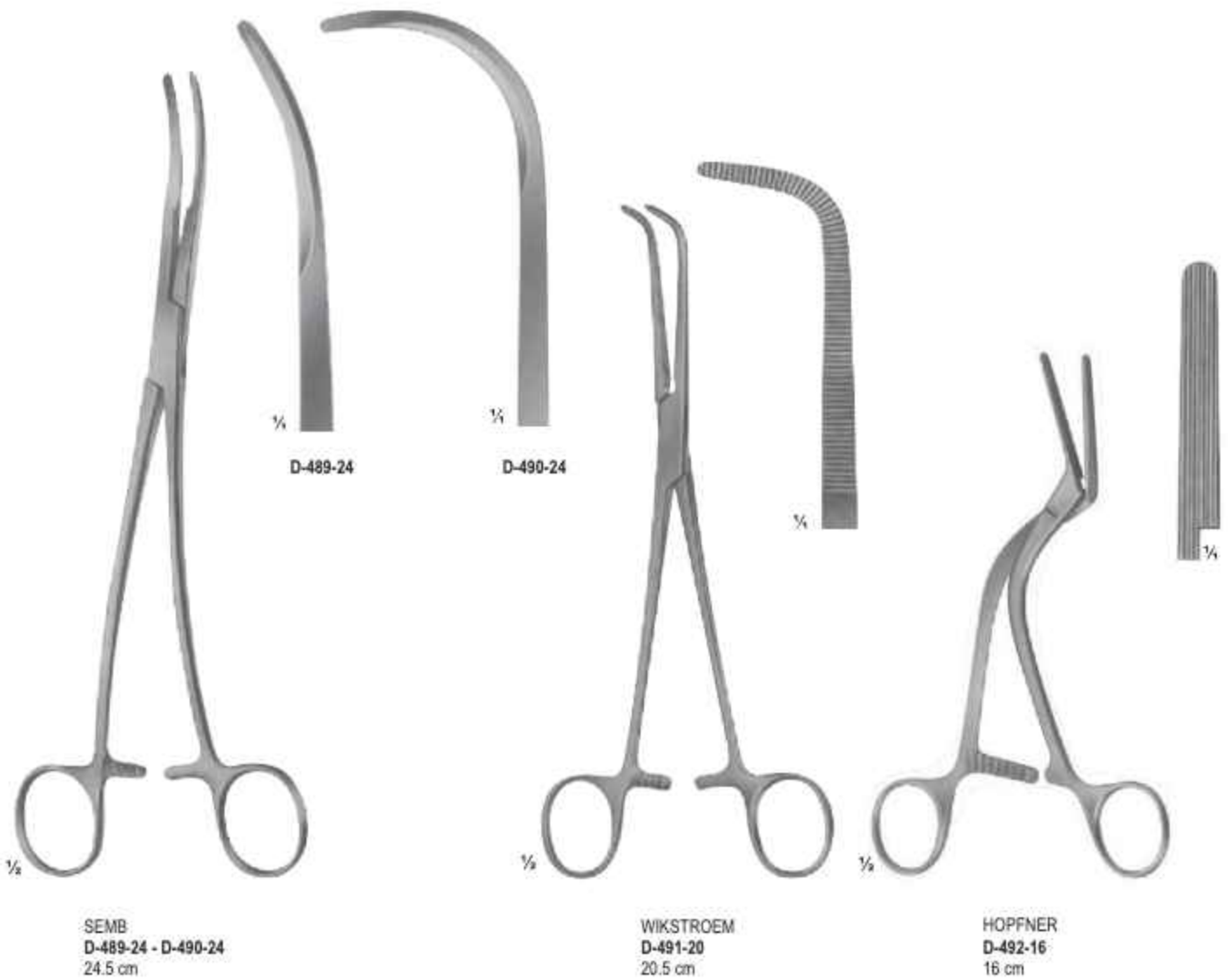

SECTION
D

Tubing Clamps



BENELUX
surgical

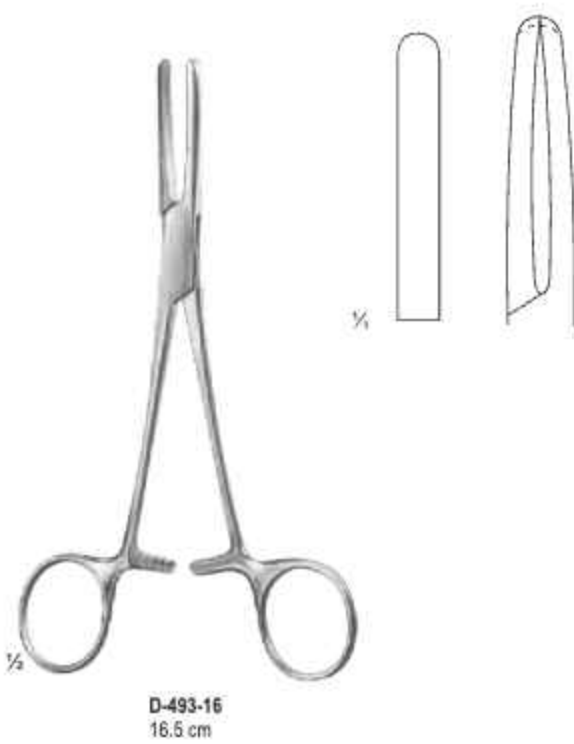

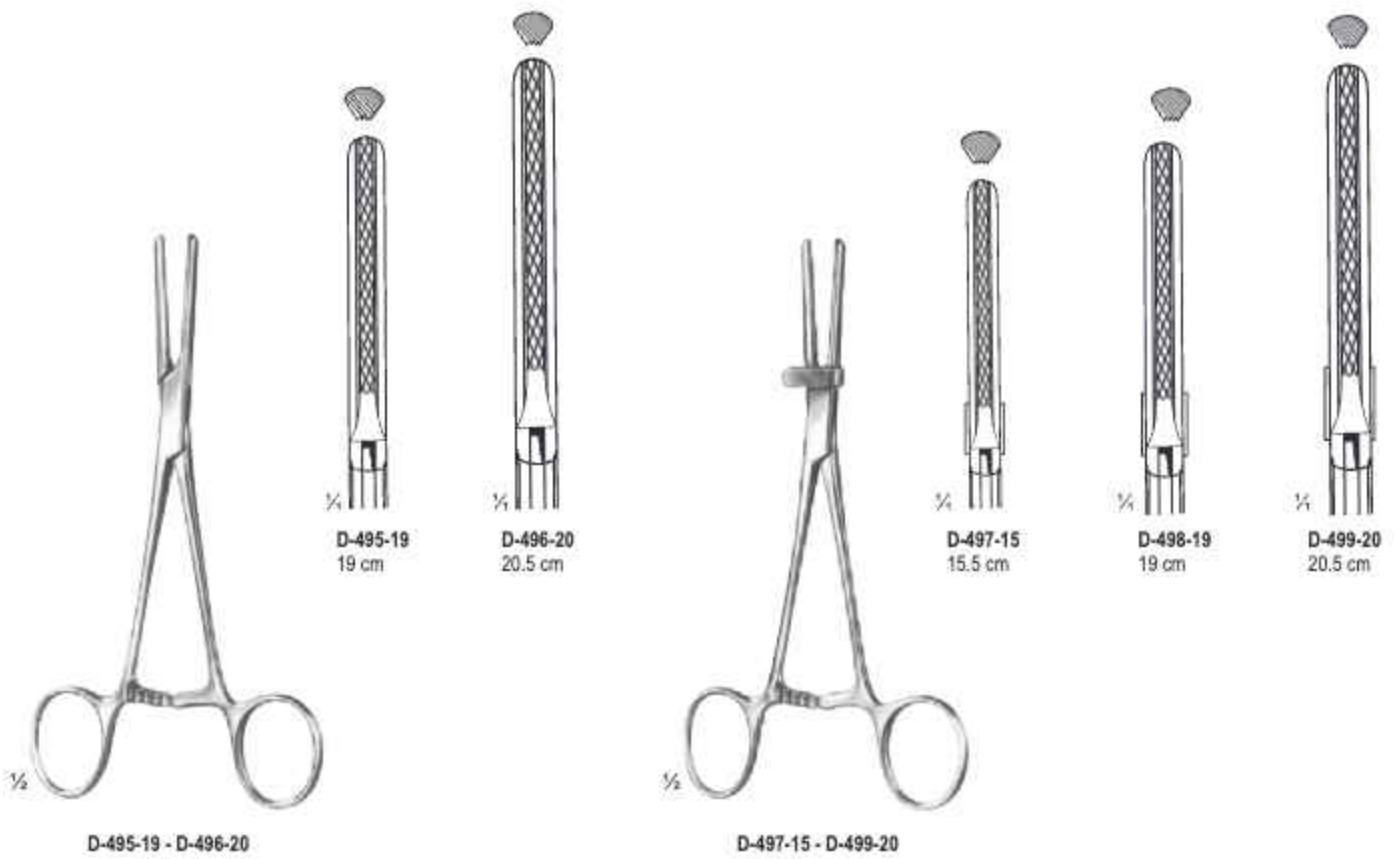



BENELUX
s u r g i c a l

Page 115-123

SECTION

E

- Dressing Forceps
- Sponge And Dressing Forceps
- Sponge Forceps
- Uterine Dressing Forceps
- Tendon Seizing Forceps



ULRICH
E-100-22
22.5 cm

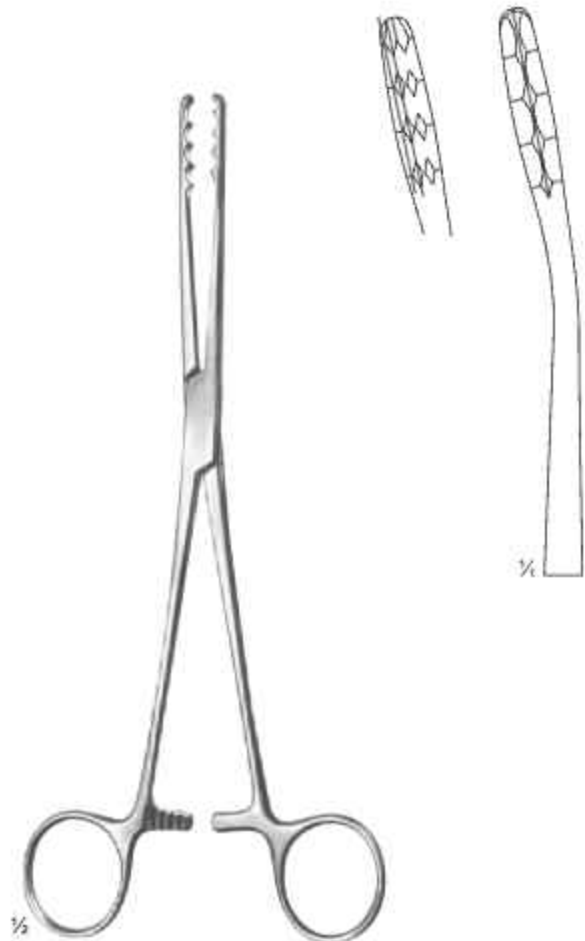
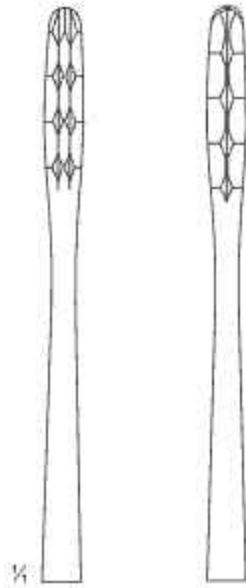

ULRICH
E-101-22
22.5 cm

SECTION
E

Dressing Forceps



BENELUX
surgical



ULRICH
E-102-26
26.5 cm

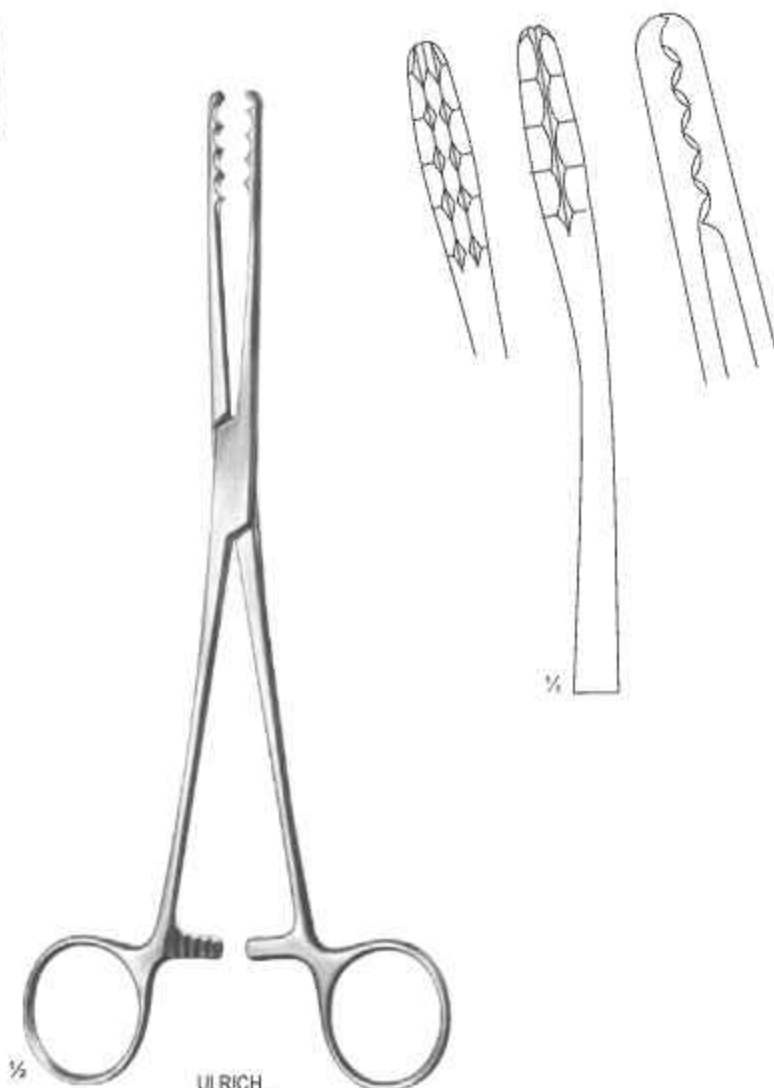
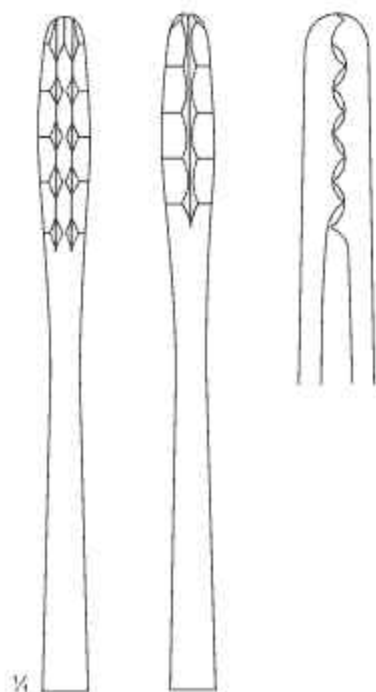

ULRICH
E-103-26
26.5 cm



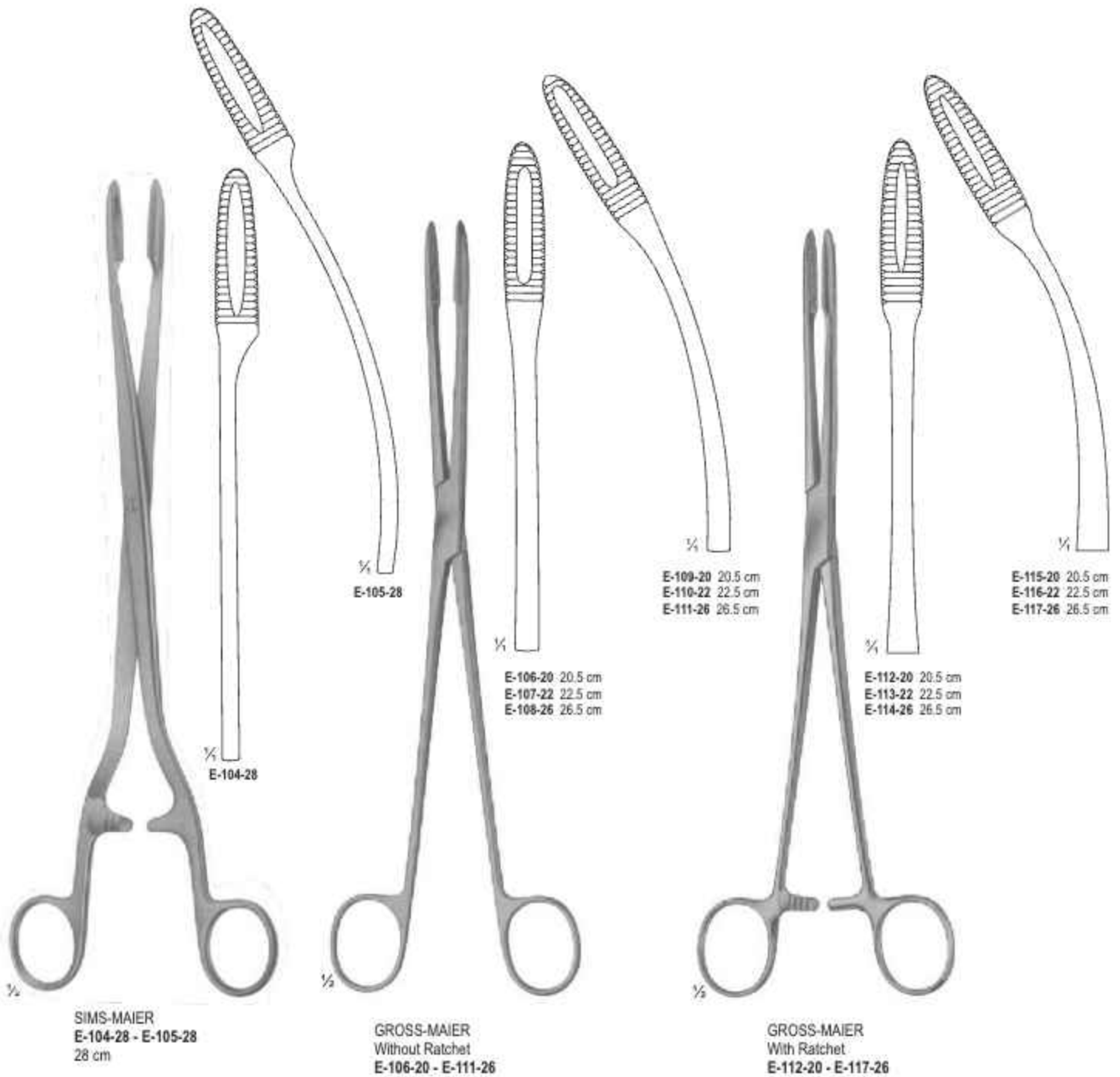

SECTION
E

Sponge And Dressing Forceps



BENELUX
surgical



1. COLLIN
E-118-24
24 cm

2. CHERON
E-119-24
24 cm

3. EMMET
E-120-21
21 cm

4. LISTER
E-121-13 - E-123-18
E-121-13 13 cm
E-122-16 16 cm
E-123-18 18.5 cm



FOERSTER-BALLENGER
E-124-18 - E-129-25



Serrated Jaws
E-124-18 18 cm
E-125-20 20.5 cm
E-126-25 25 cm

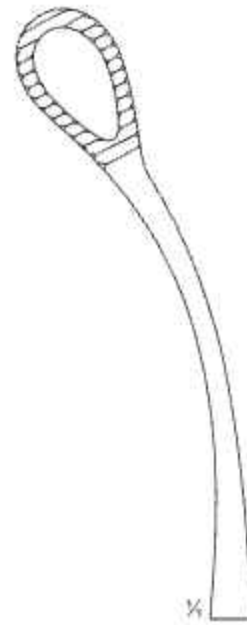

Serrated Jaws
E-127-18 18 cm
E-128-20 20.5 cm
E-129-25 25 cm

**SECTION
E**

Sponge Forceps

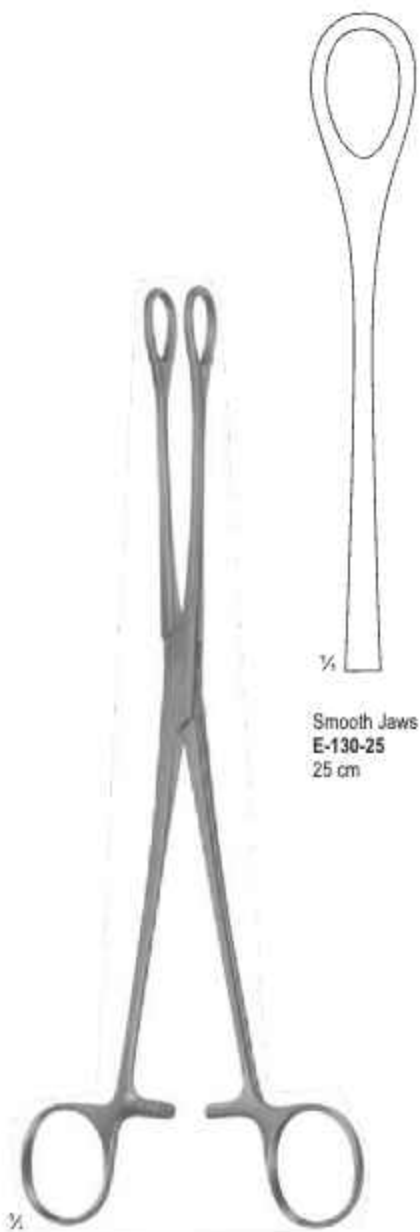

FOERSTER-BALLENGER
E-130-25 - E-131-25



Smooth Jaws
E-130-25
25 cm

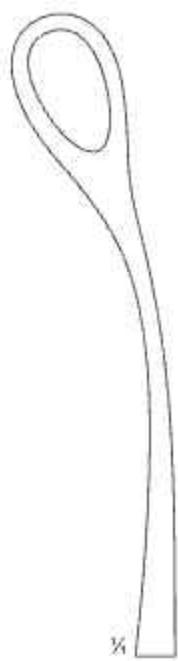

Smooth Jaws
E-131-25
25 cm



FÖRSTER
E-132-25 - E-133-25

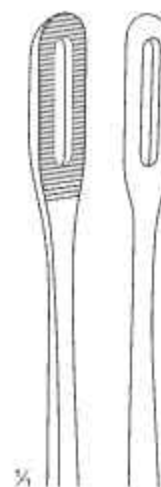

E-132-25
25 cm

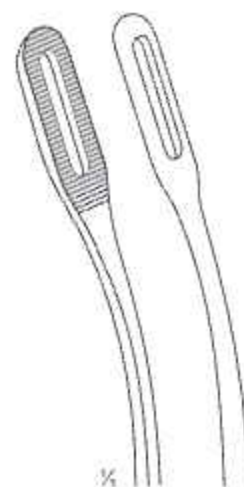

E-133-25
25 cm



BERGMANN
E-134-24
24 cm



RAMPLEY
E-135-18 - E-136-25



E-135-18
18 cm



E-136-25
25 cm

SECTION
E

Uterine Dressing Forceps

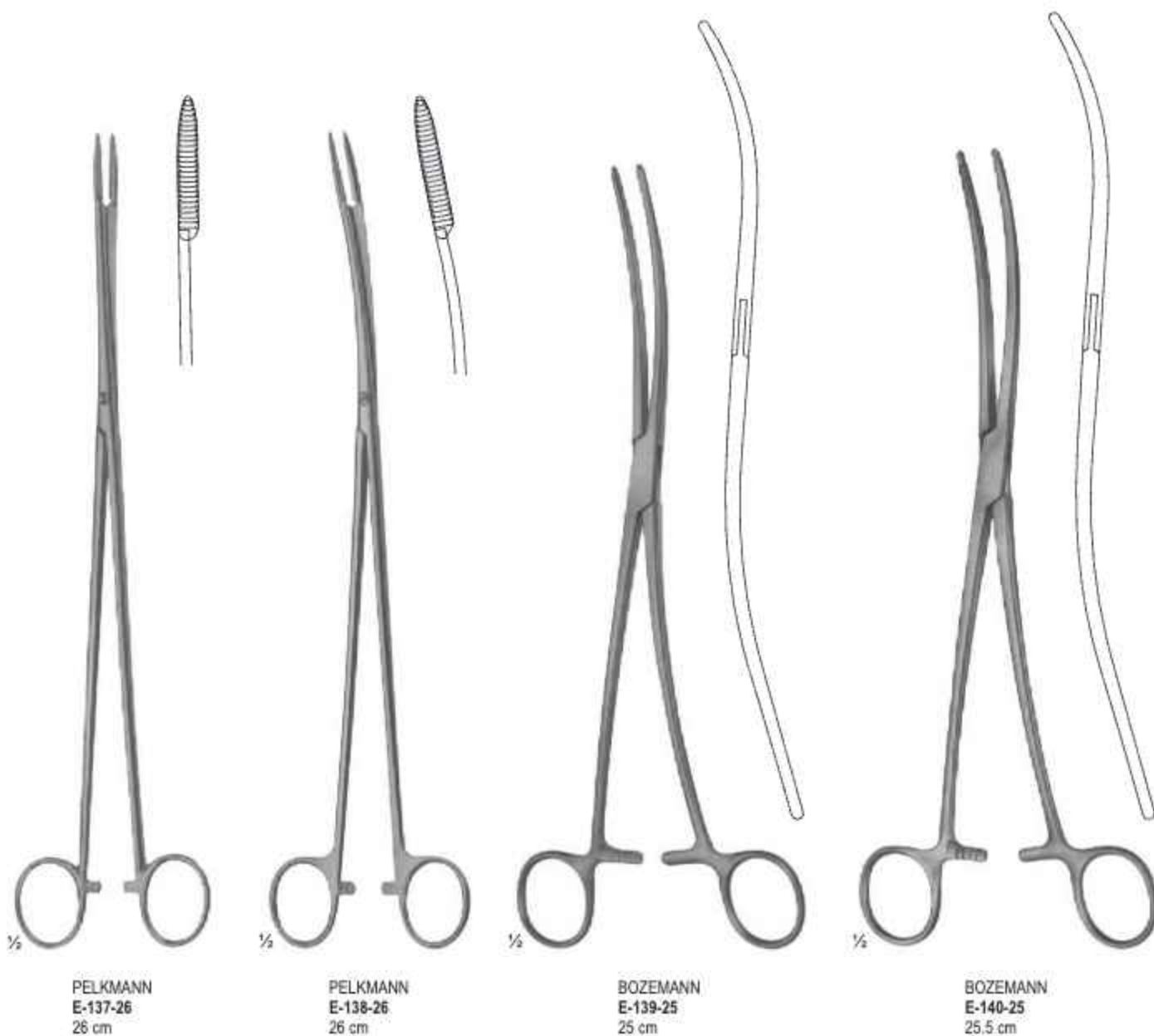

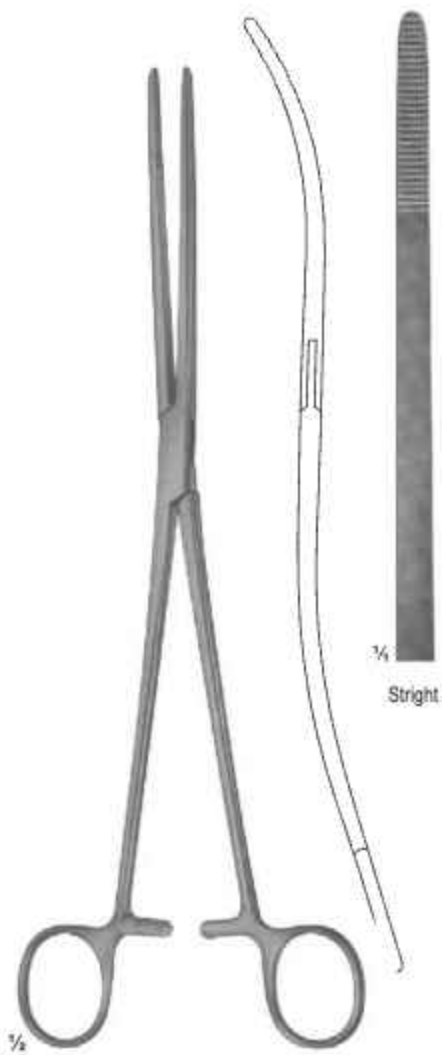

BOZEMANN
E-141-26 - E-142-25
E-141-26 26 cm
E-142-25 25 cm

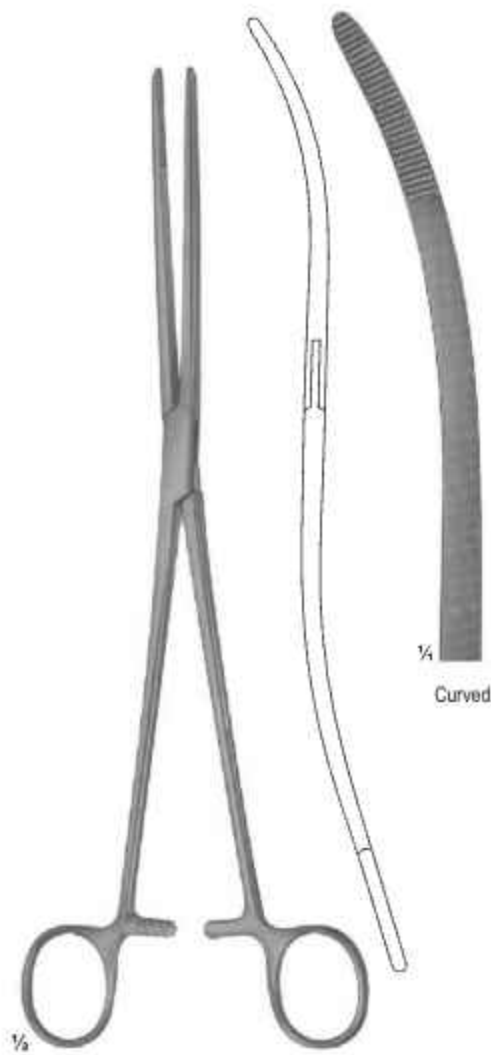

BOZEMANN
E-143-26 - E-144-25
E-143-26 26 cm
E-144-25 25 cm

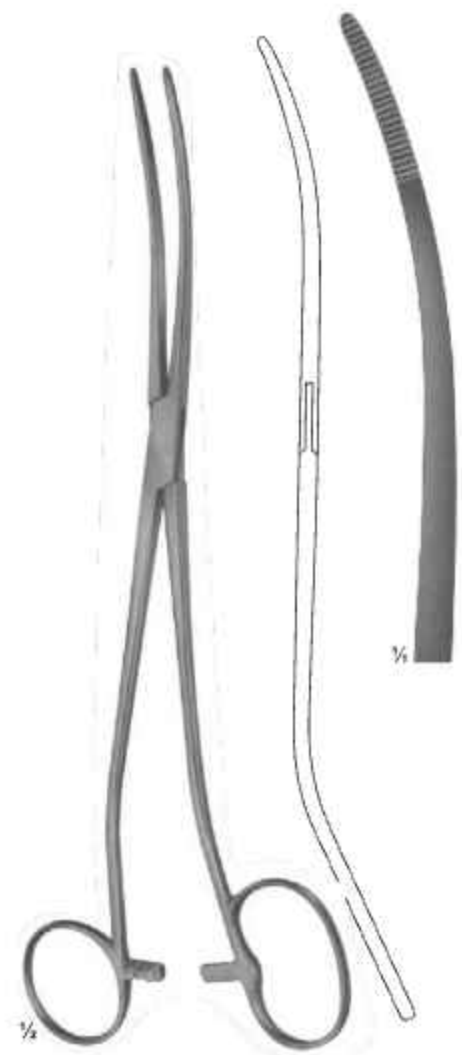

BOZEMANN-DOUGLAS
E-145-26
26 cm



BENELUX
s u r g i c a l

SECTION

F

Page 124-180

- Fine Wound Retractors (dura and Skin Retractors)
- Wound – Trachea Retractors
- Retractors With Triangular Handle
- Retractors
- Saddle Hooks and Vain Hooks
- Bone Retractors
- Retractors, Deep Form
- Aorta Retractors
- Retractors For Deep Surgery
- Spatulas Retractors
- Lung Spatulas
- Atrum Retractors
- Retractors For Deep Surgery (abdominal Retractors)
- Abdominal Retractors
- Pelvis Retractors
- Abdominal and Intestinal Spatulas
- Hooklets
- Wound Spreaders, Self-Retaining
- Self-Retaining Retractors
- Self-Retaining Laminectomy Retractors
- Special Retractors
- Self-Retaining Retractors For Laminectomy and Other Operations
- Retractors For Cervical Spine
- Self-Retaining and Abdominal Retractors



GRAEFE
F-100-12 Sharp
F-101-12 Blunt
12.5 cm



GUTHRIE
F-102-12 12.5 cm
F-103-13 13 cm
Sharp



ROLLET
F-104-13 13 cm
F-105-13 13.5 cm
Sharp
F-106-13 13.5 cm
Blunt



FRAZIER
Dura Retractors
F-107-13
13 cm



TONNIS
Dura Retractors
F-108-15
15 cm



KILNER
F-109-16
16 cm



FREER
F-110-15
15 cm



MULLER
F-111-15
15 cm



MULLER
F-112-15
15 cm



COTTLE
F-113-16
16 cm

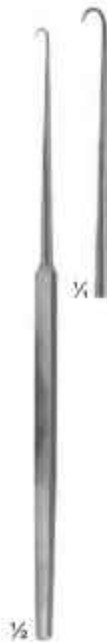

COTTLE
F-114-16
16 cm



JAEGAR
F-115-13
13.5 cm



JOSEPH
F-116-16 - F-119-08
16.5 cm



GILLIES
F-120-18 - F-121-18
18 cm



KILNER
Sharp
F-122-08
8 cm



CONVERSE
Blunt
F-123-12
12 cm

**SECTION
F**

Wound - Trachea Retractors



**BENELUX
surgical**



**BERGMANN
F-124-14**
14 cm



F-125-18 - F-127-18
18 cm



**F-125-18
Sharp**

**F-127-18
Blunt**



**F-126-18
Blunt**



F-128-15 - F-130-15
Flexible shaft, sharp
15.5 cm



F-128-15

F-129-15

F-130-15



F-131-15 - F-133-15
Flexible shaft, blunt
15.5 cm



F-131-15

F-132-15

F-133-15



F-134-16 - F-141-16
Large curve,
sharp
16.5 cm



F-134-16

F-136-16

F-138-16

F-140-16



F-135-16

F-137-16

F-139-16

F-141-16



F-142-16 - F-149-16
Large curve,
blunt
16.5 cm



F-142-16

F-144-16

F-146-16

F-148-16

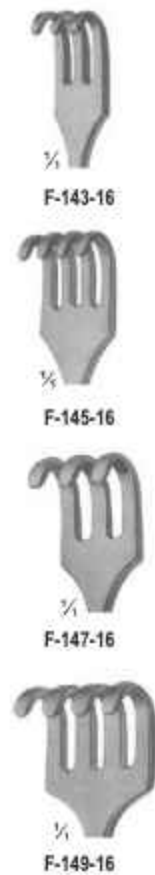

F-143-16

F-145-16

F-147-16

F-149-16



MANNERFELT modif.
Sharp
F-150-13
13.5 cm

MANNERFELT modif.
Sharp
F-151-15
15.5 cm



MANNERFELT modif.
Sharp
F-152-15
15.5 cm



MANNERFELT modif.
Small curve, sharp
F-153-15 - F-155-15
15.5 cm



F-153-15



F-154-15



F-155-15



MANNERFELT modif.
Large curve, blunt
F-156-15 - F-158-15
15.5 cm



F-156-15



F-157-15



F-158-15



LANGENBECK-
MANNERFELT modif.
F-159-15 - F-162-15
15.5 cm



MANNERFELT modif.
Saddle hooks,
F-163-15 - F-165-15
15.5 cm



F-163-15
12 x 12 mm



F-164-15
12 x 14 mm



F-165-15
14 x 16 mm



MANNERFELT modif.
Saddle hooks, fenestrated
F-166-15
15.5 cm

12 x 12 mm

SECTION F

Retractors

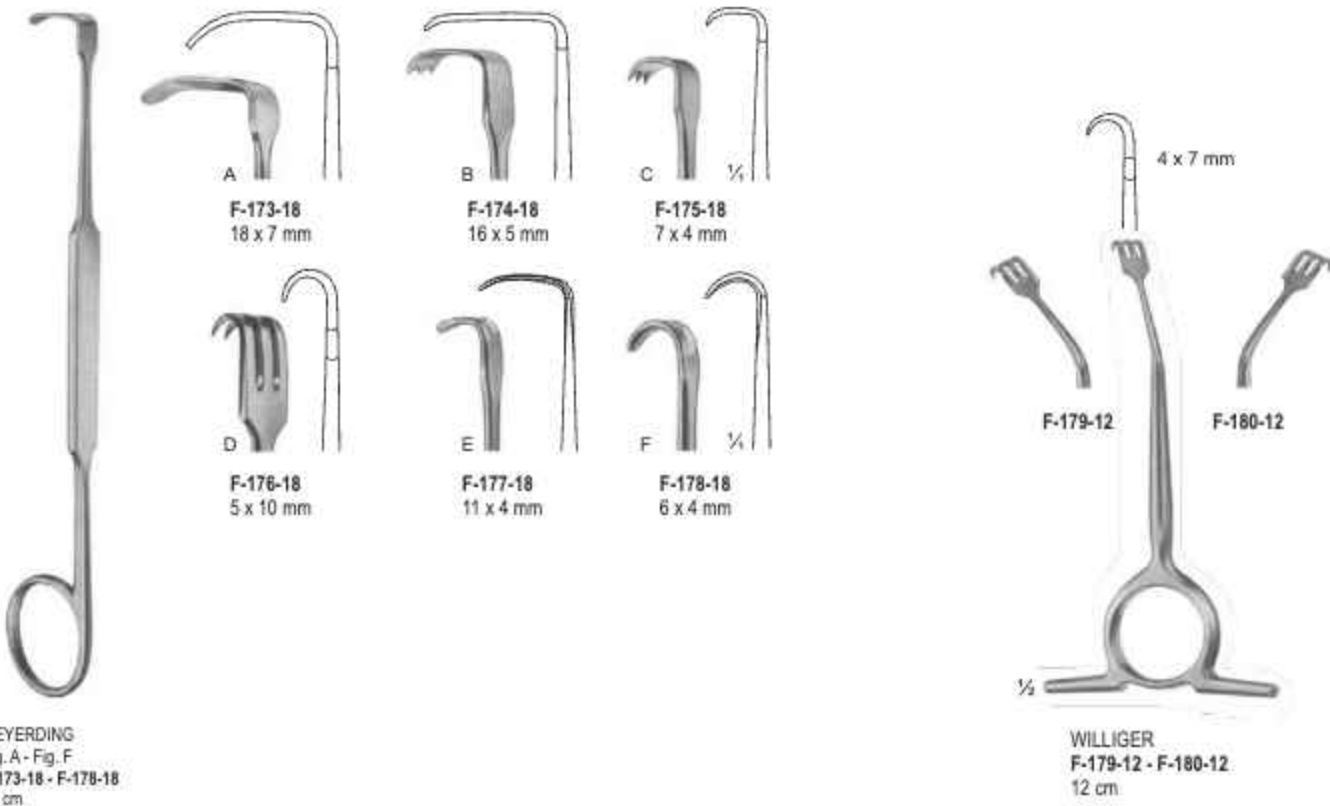



EMMET
Fistula hook
F-181-22
22 cm



SIMON
Fistula hook
F-182-22
22 cm



SIMON
Fistula hook
F-183-22
22 cm



LANGE
Fistula hook
F-184-23
23 cm

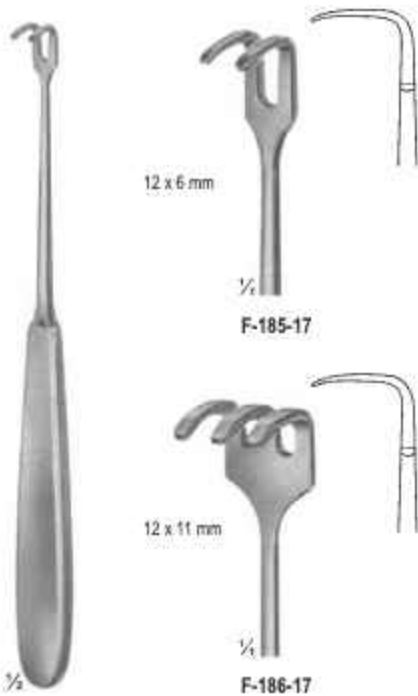

Tendon hooks
F-185-17 - F-186-17
17.5 cm

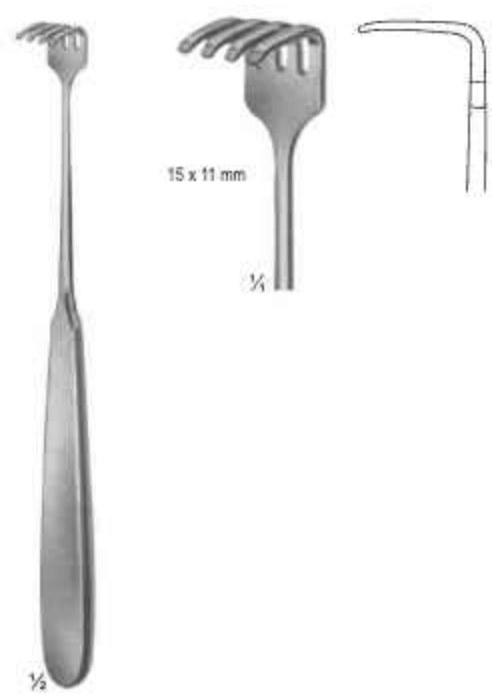

KLAPP
Tendon hooks
F-187-17
17.5 cm

SECTION F

Retractors

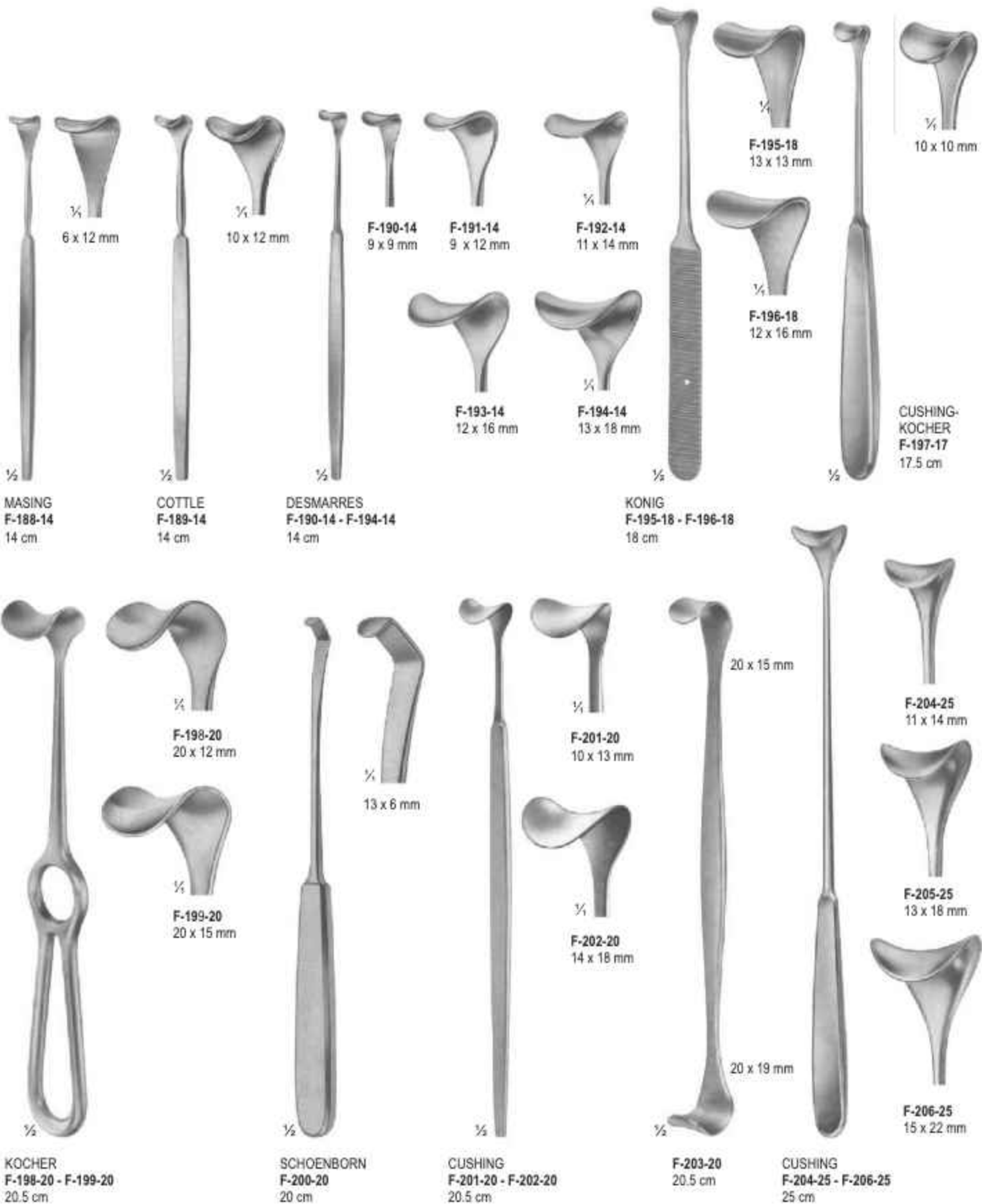



GILL-VERNET
F-207-04 - F-214-23
Malleable Shaft
24 cm



F-207-04
4 mm



F-208-06
6 mm



F-209-08
8 mm



F-210-11
11 mm



F-211-15
15 mm



F-212-17
17 mm



F-213-20
20 mm



F-214-23
23 mm



STANDELL-STILLE
F-215-19 - F-216-19
19 cm



Fig. 1
F-215-19
Smooth Blade End



Fig. 2
F-216-19
Toothed Blade End



LAHEY
F-217-19
19.5 cm

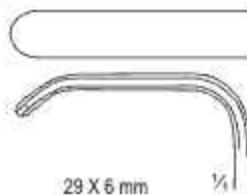

29 X 6 mm



LITTLE
F-218-20
20.5 cm



13 X 15 mm

**SECTION
F**

Bone Retractors



**BENELUX
surgical**



**KOCHER
Sharp
F-219-20
20.5 cm**



**KOCHER
Sharp
F-220-22
22 cm**



**KOCHER
Blunt
F-221-22
22 cm**



**VOLKMANN
Sharp
F-222-22
22 cm**



**VOLKMANN
Sharp
F-223-22
22 cm**



**VOLKMANN
F-224-22 - F-231-22
22.5 cm**

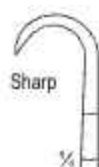

Sharp



**F-224-22
9 x 8 mm**



**F-225-22
9 x 13 mm**



**F-226-22
9 x 19 mm**



**F-227-22
9 x 29 mm**



Blunt



**F-228-22
8.5 x 8 mm**



**F-229-22
8.5 x 13 mm**



**F-230-22
8.5 x 19 mm**



**F-231-22
8.5 x 29 mm**

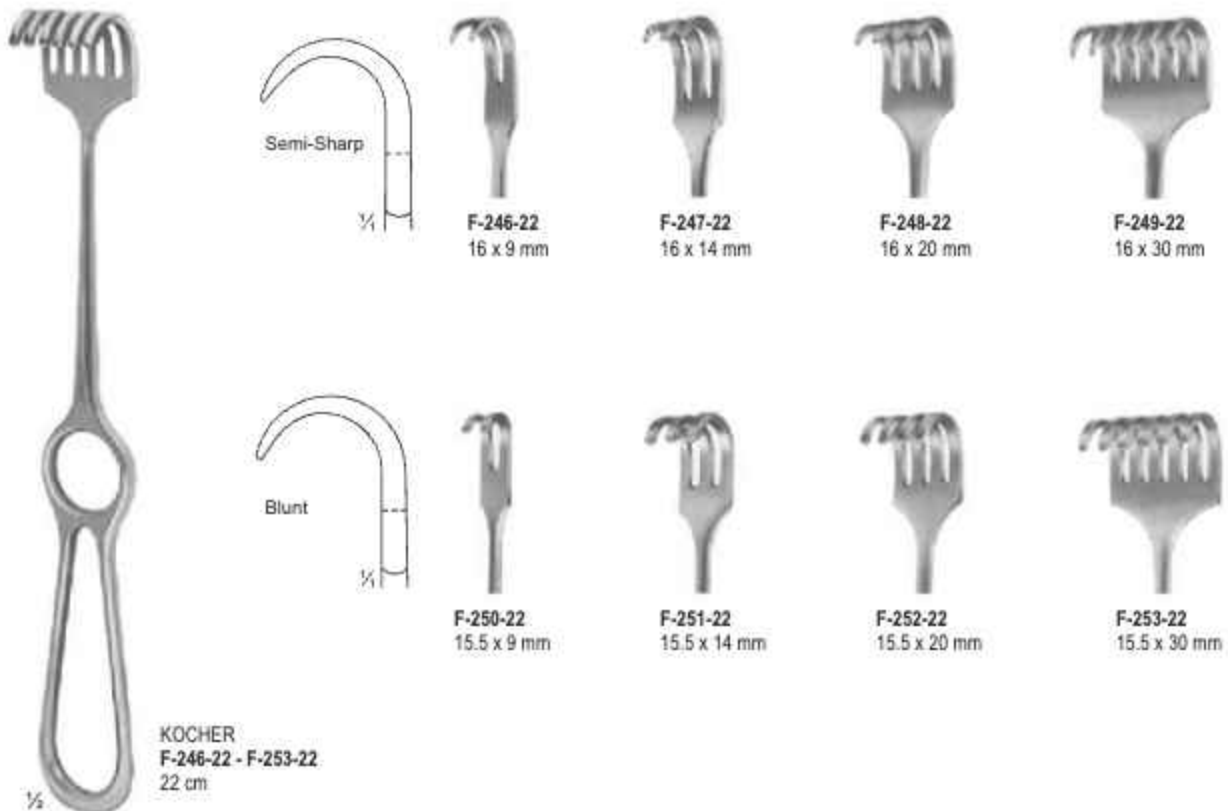
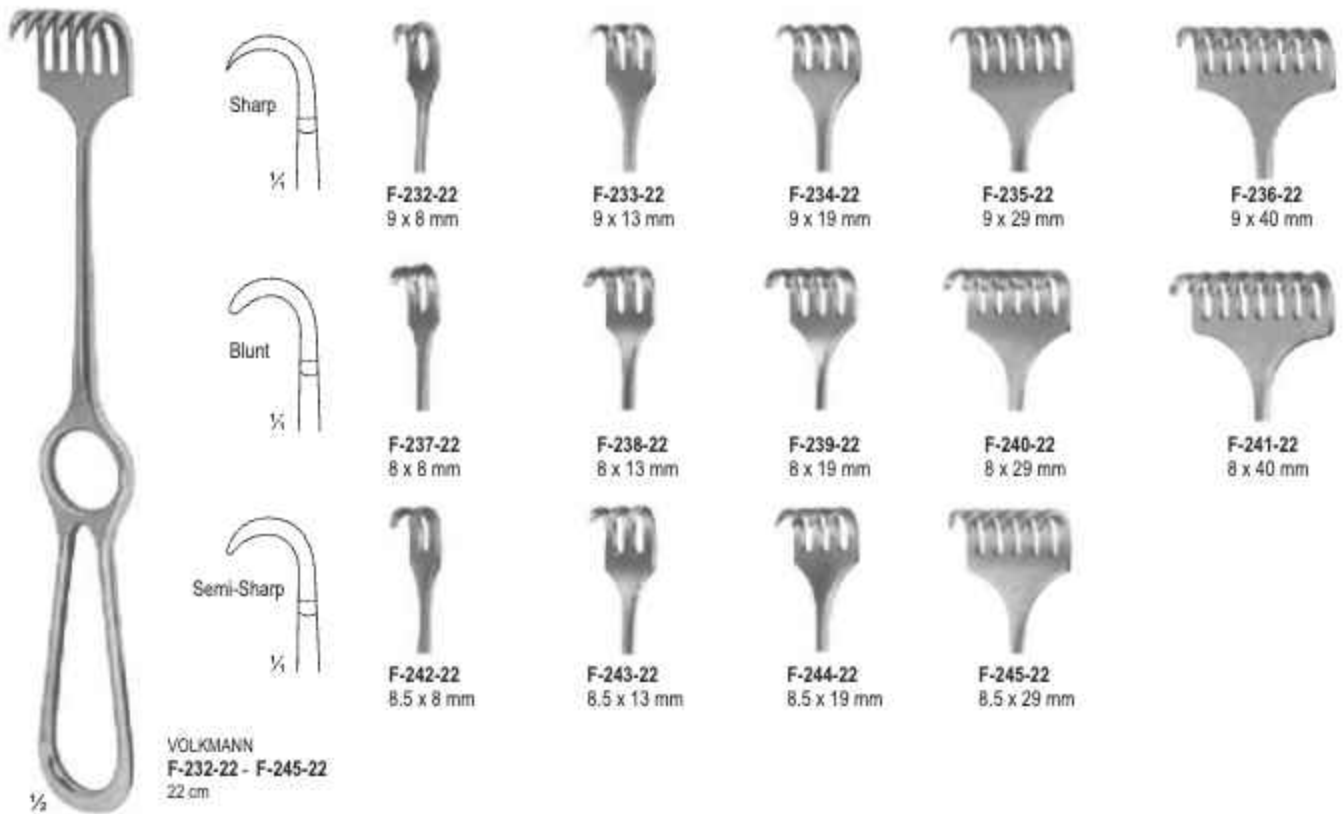

**SECTION
F**

Retractors, Deep Form



KORTE
F-254-24 - F-255-24
24 cm



F-254-24
8 Prongs, blunt



F-255-24
8 Prongs, sharp



ISRAEL
F-256-25 - F-259-25
25.5 cm

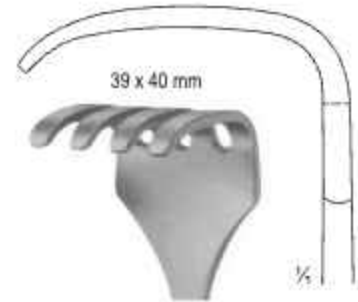

F-256-25
4 Prongs, blunt

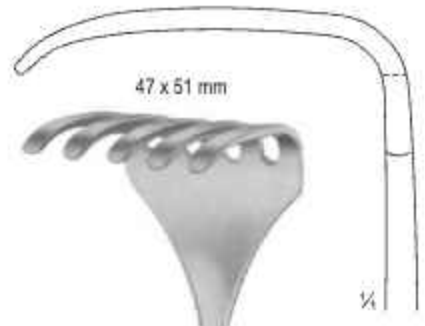

F-257-25
5 Prongs, blunt

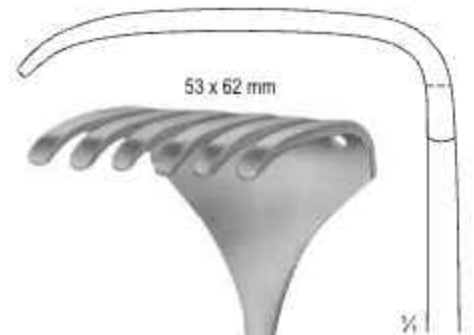

F-258-25
6 Prongs, blunt

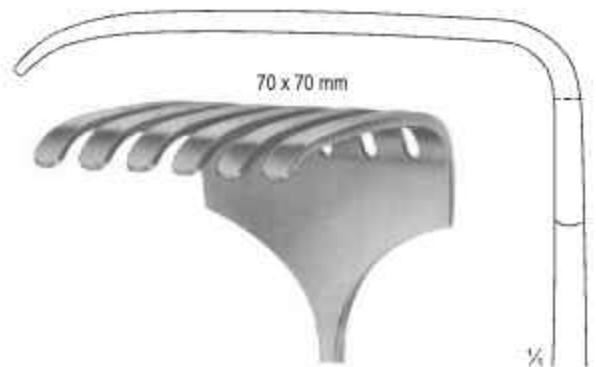

F-259-25
6 Prongs, blunt



LANGENBECK
F-260-21 - F-265-21
21 cm
F-260-21 28 x 10 mm
F-261-21 28 x 14 mm
F-262-21 33 x 14 mm
F-263-21 28 x 16 mm
F-264-21 40 x 10 mm
F-265-21 40 x 13 mm



KOCHER-LANGENBECK
F-266-21 - F-272-21
21.5 cm
F-266-21 25 x 6 mm
F-267-21 35 x 8 mm
F-268-21 35 x 11 mm
F-269-21 35 x 15 mm
F-270-21 41 x 11 mm
F-271-21 55 x 11 mm
F-272-21 70 x 14 mm



LANGENBECK
F-273-21
21.5 cm

SECTION
F

Retractors



KOCHER
F-274-23 - F-278-23
23 cm

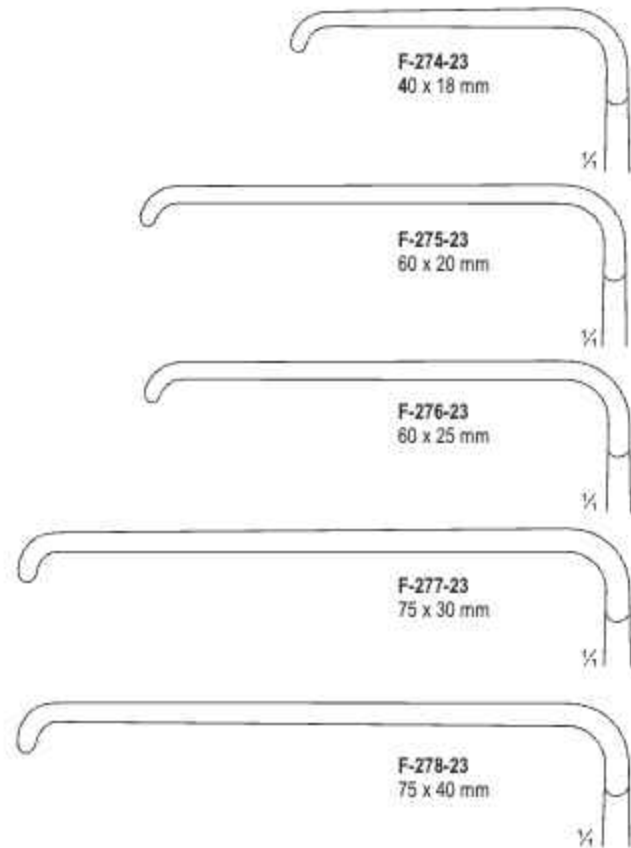

SAUERBRUCH
F-279-22 - F-281-22
22.5 cm

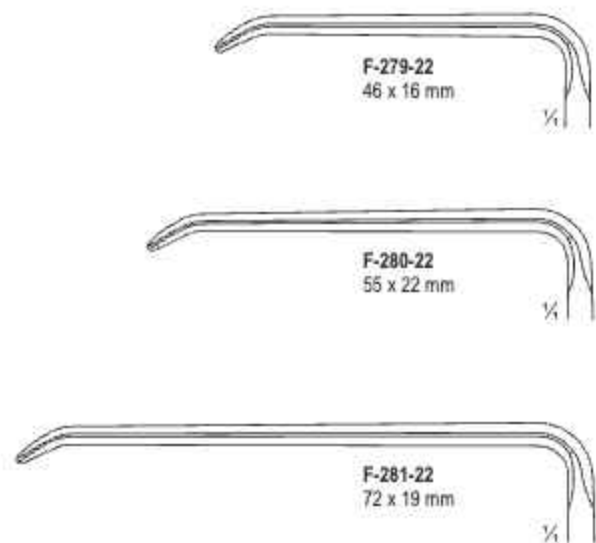



MINI-ZENKER
F-282-18
18 cm
10 X 3 mm

1/4



F-283-25
25 cm
35 X 8 mm

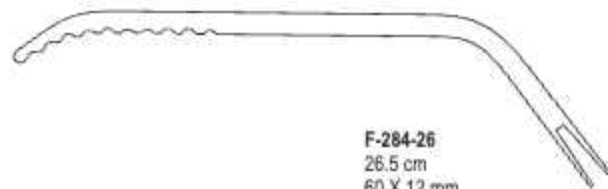

F-284-26
26.5 cm
60 X 12 mm

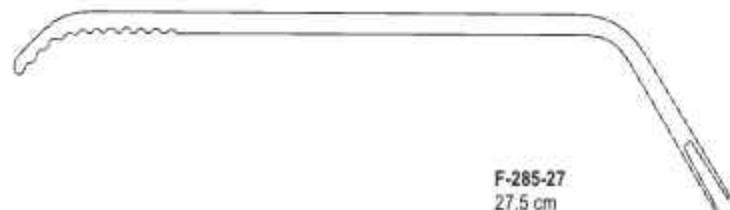

F-285-27
27.5 cm
75 X 12 mm



F-286-28
28.5 cm
85 X 20 mm



F-287-30
30.5 cm
100 X 25 mm



1/2

ZENKER
F-282-18 - F-287-30

SECTION
F

Retractors



BENELUX
surgical



KOCHER
F-288-21 - F-289-21
21.5 cm



$\frac{1}{4}$
F-288-21
20 X 12 mm



F-289-21
23 X 14 mm



KOCHER
F-290-22 - F-292-23



$\frac{1}{4}$
F-290-22
22 cm
40 X 10 mm



F-291-23
23 cm
40 X 15 mm



F-292-23
23 cm
40 X 20 mm



F-293-22
15 x 15 mm
22 cm



F-294-21
20 x 22 mm
21.5 cm



F-295-23
28 x 28 mm
23.5 cm

MIDDELDORPF
F-293-22 - F-295-23



1/2

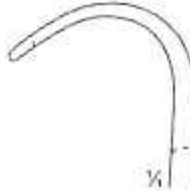

1/2

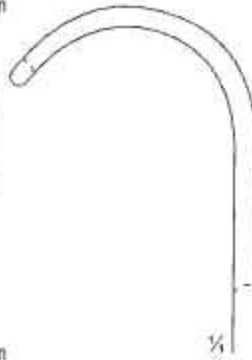

1/2



1/2

BUCHS
F-296-20
20.5 cm



38 x 18 mm



67 x 17 mm



CASPAR
F-297-21
21 cm



36 x 20 mm

KOCHER
F-298-23
23 cm



F-299-20
40 x 12 mm



F-300-20
55 x 14 mm

DOCKHORN
F-299-20 - F-300-20
20 cm

SECTION
F

Retractors



HOSEL
F-301-25 - F-306-25
25 cm

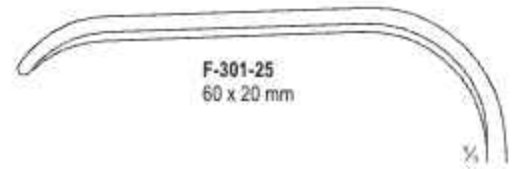

F-301-25
60 x 20 mm

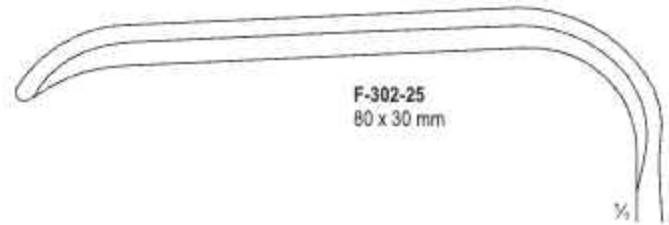

F-302-25
80 x 30 mm

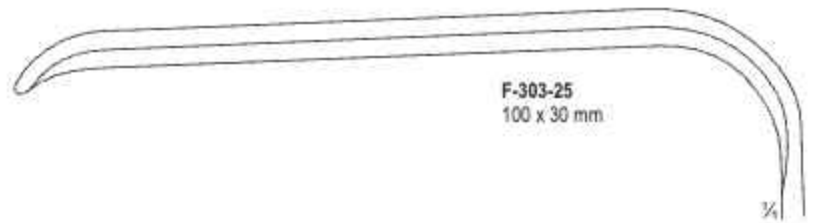

F-303-25
100 x 30 mm

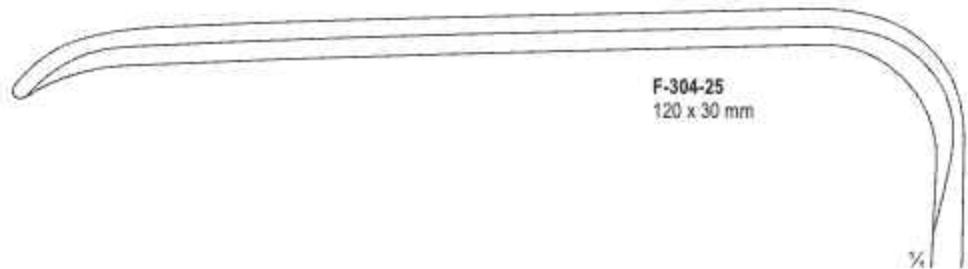

F-304-25
120 x 30 mm

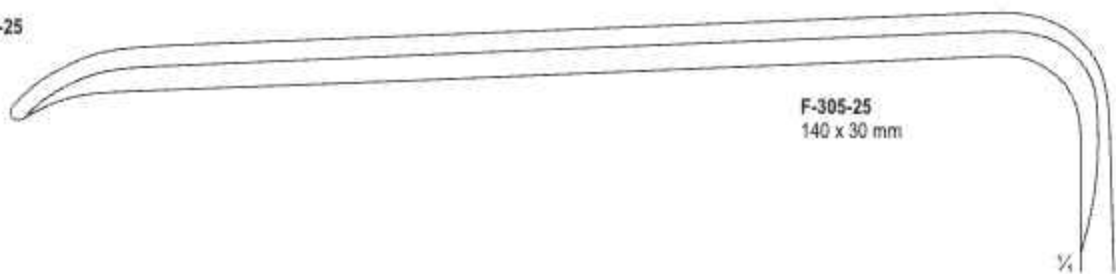

F-305-25
140 x 30 mm

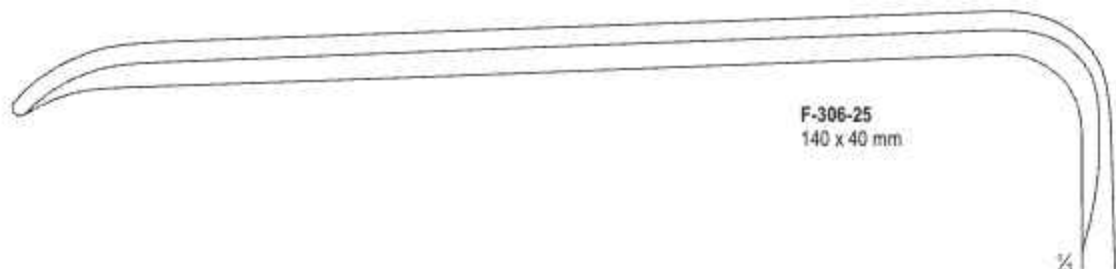

F-306-25
140 x 40 mm

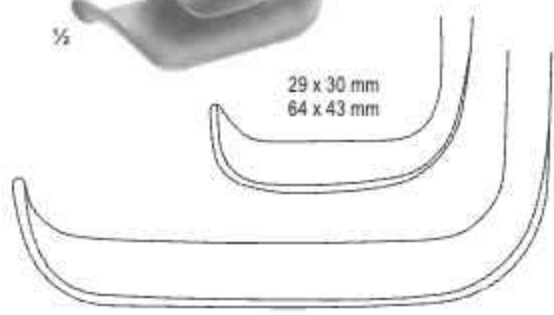

RICHARDSON-EASTMAN
Set
F-307-25 - F-308-27
25 cm
F-307-25 25 cm
F-308-27 27 cm



RICHARDSON
F-312-24
24 cm

RICHARDSON
F-309-24 - F-311-24
24 cm

SECTION
F

Retractors

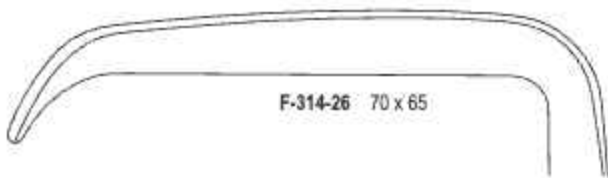

KELLY
F-313-26 - F-314-26
26 cm

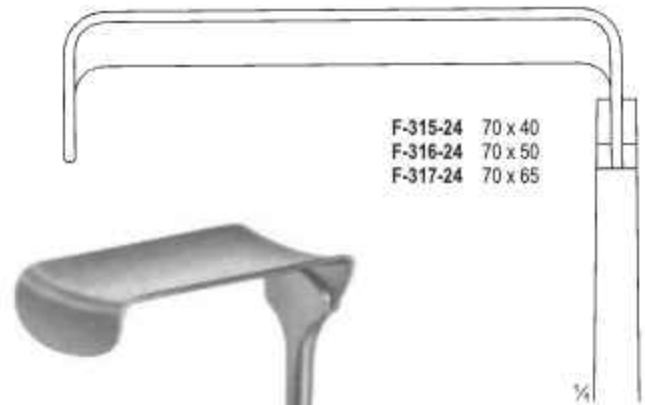

MORRIS
F-315-24 - F-317-24
24.5 cm



HÖSEL
F-318-26 - F-323-26
26 cm

1/2

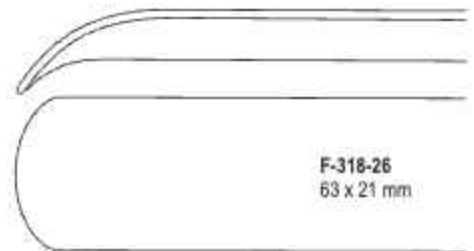

F-318-26
63 x 21 mm



F-319-26
83 x 30 mm



F-320-26
103 x 30 mm



F-321-26
120 x 30 mm



F-322-26
140 x 30 mm



F-323-26
140 x 40 mm

SECTION
F

Retractors



1/4

F-324-27
27 cm
43 X 45 mm

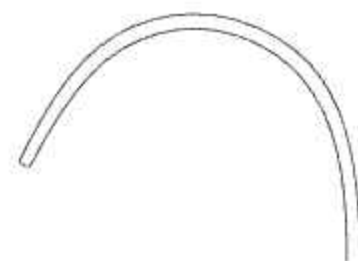

1/2

MIDDENDORPF
F-324-26 - F-326-28



F-325-27
27 cm
52 X 50 mm



F-326-28
28 cm
52 X 70 mm

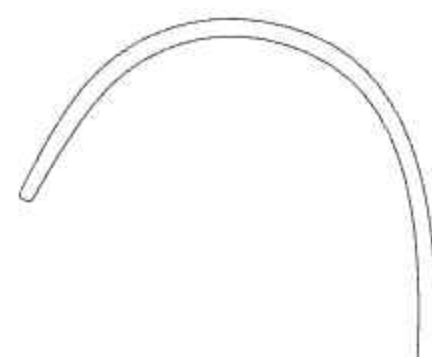



1/2

ROSS
F-327-24 - F-332-25
Flexible Shaft



Fig. 1
F-327-24
24 cm



Fig.
F-328-24
24,5 cm



Fig. 3
F-329-25
25 cm



Fig. 4
F-330-25
25,5 cm



Fig. 5
F-331-28
27 cm

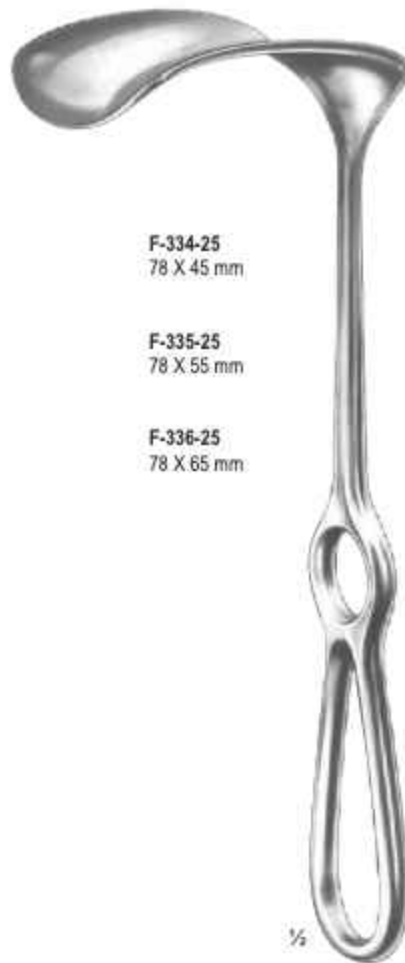

Fig. 6
F-332-25
25,5 cm



1/2

KOCHER
F-333-23
23,5 cm
70 X 25 mm



1/2

F-334-25
78 X 45 mm

F-335-25
78 X 55 mm

F-336-25
78 X 65 mm

KOCHER
F-334-25 - F-336-25
25 cm

SECTION
F

Retractors For Deep Surgery



SECTION
F

Retractors For Deep Surgery

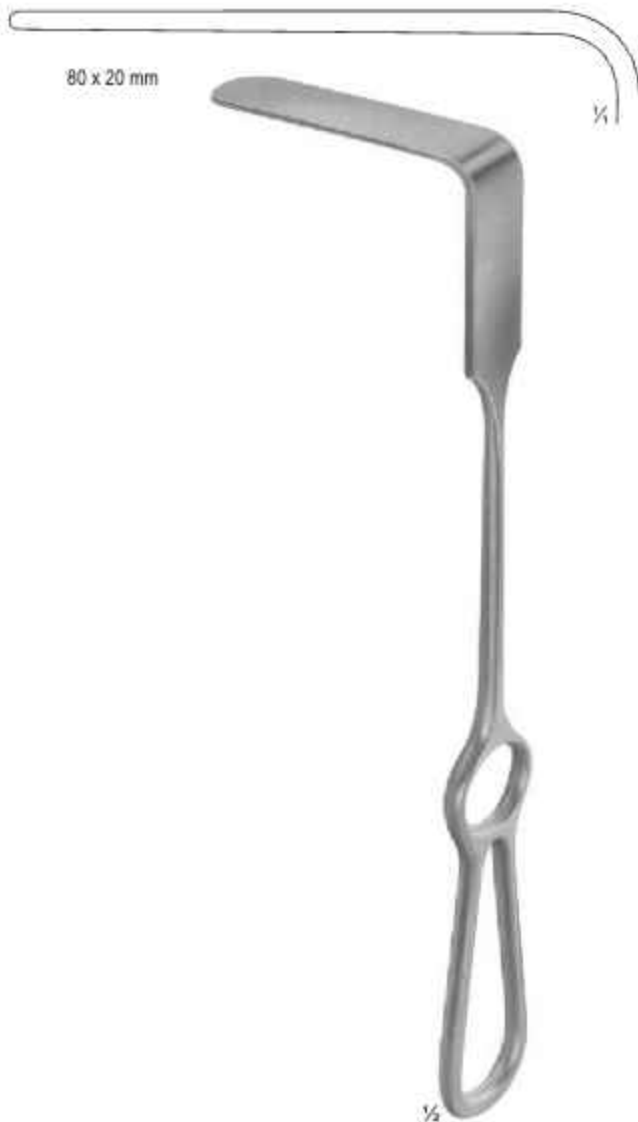

BRUNNER
F-344-27 - F-350-27
27.5 cm

| | |
|----------|----------|
| F-344-27 | 80 x 20 |
| F-345-27 | 100 x 25 |
| F-346-27 | 120 x 25 |
| F-347-27 | 130 x 30 |
| F-348-27 | 140 x 30 |
| F-349-27 | 160 x 30 |
| F-350-27 | 180 x 30 |



F-351-28
Handle with cold
light carrier for
retractor blades.
28 cm

Handle arrange-
ment variable

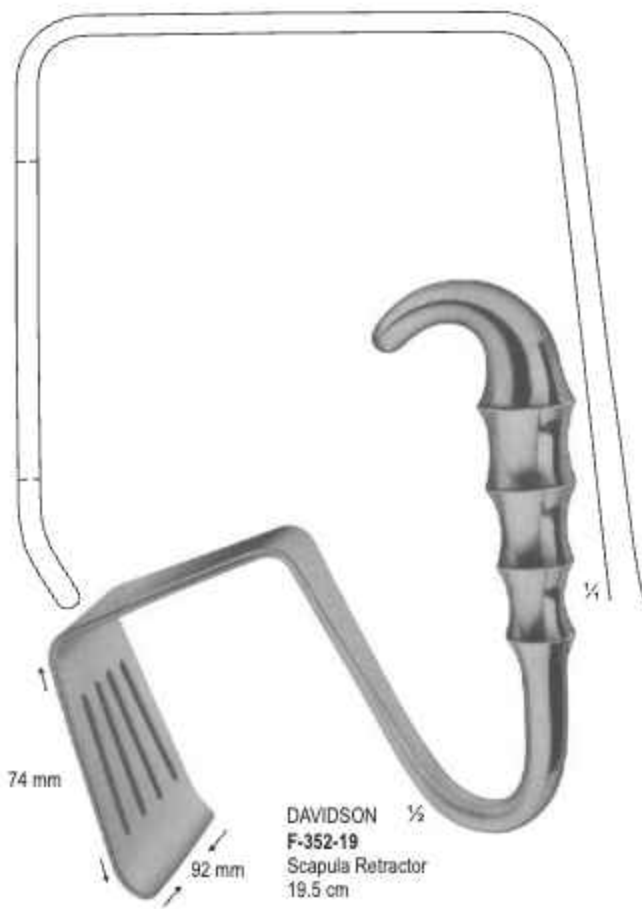

DAVIDSON $\frac{1}{2}$
F-352-19
Scapula Retractor
19.5 cm

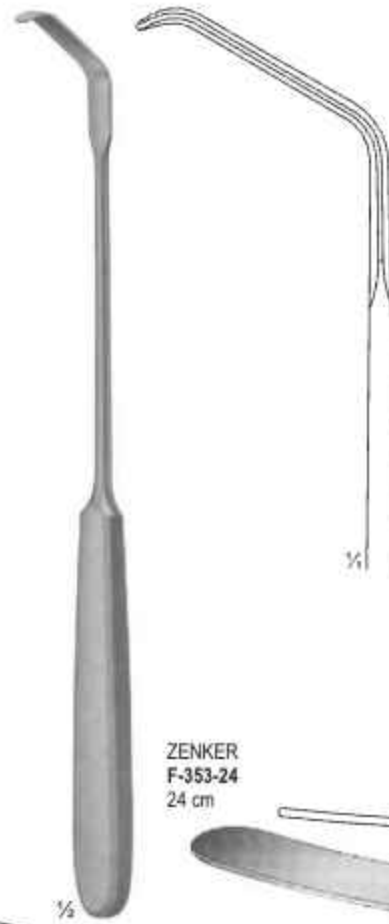

ZENKER
F-353-24
24 cm



Fig. 000
DEAVER
F-354-18
18 cm

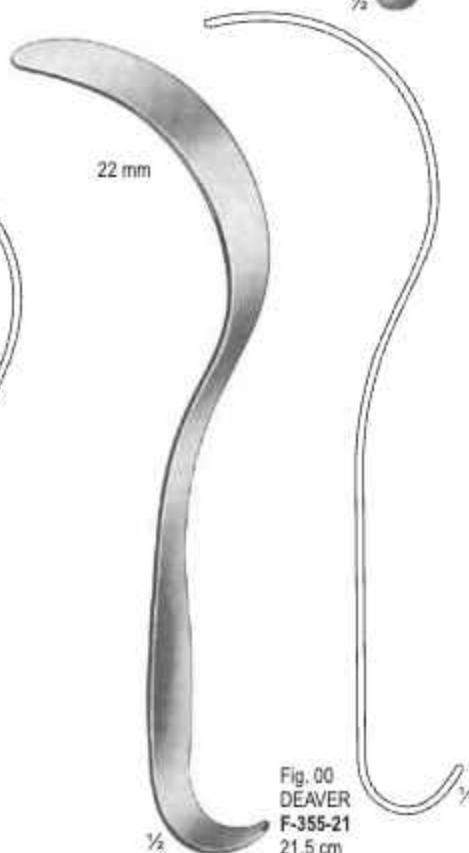

Fig. 00
DEAVER
F-355-21
21.5 cm

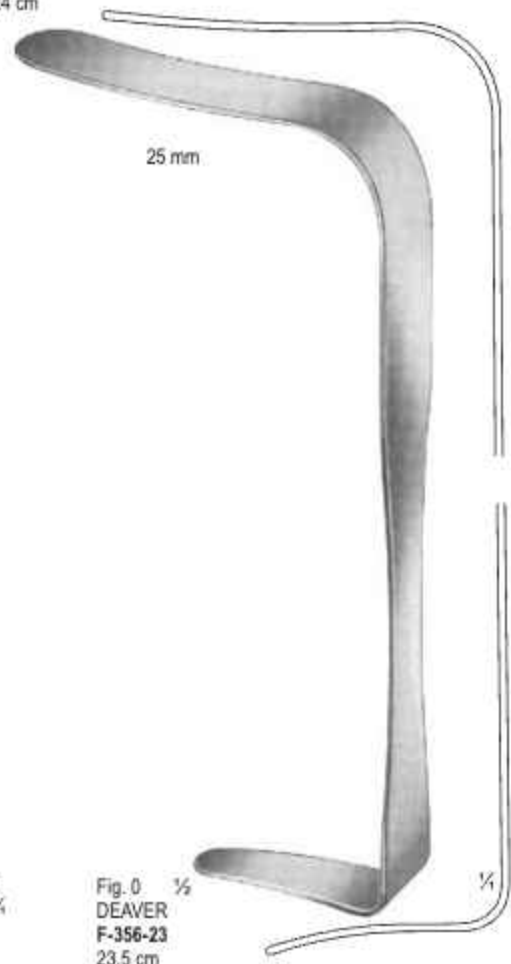

Fig. 0 $\frac{1}{2}$
DEAVER
F-356-23
23.5 cm

SECTION
F

Retractors, Lung Spatulas



Fig. 1
DEAVER
F-357-30
30 cm

Fig. 2
DEAVER
F-358-31
31.5 cm

Fig. 2
DEAVER
F-359-36
36.5 cm



Fig. 3
DEAVER
F-360-30
30 cm

Fig. 4
DEAVER
F-361-31
31 cm

Fig. 5
DEAVER
F-362-32
32 cm



Fig. 1
DEAVER
F-363-31
31 cm



Fig. 3
DEAVER
F-364-31
31 cm



Fig. 3
DEAVER
F-365-30
30.5 cm



Fig. 4
DEAVER
F-366-31
31 cm

SECTION
F

Atrium Retractors



COOLEY
F-367-25
25 cm
Right
48 X 48 mm



COOLEY
F-368-25
25 cm
Right, Serrated
48 X 48 mm



COOLEY
F-369-27
27.5 cm
Left
30 X 48 mm

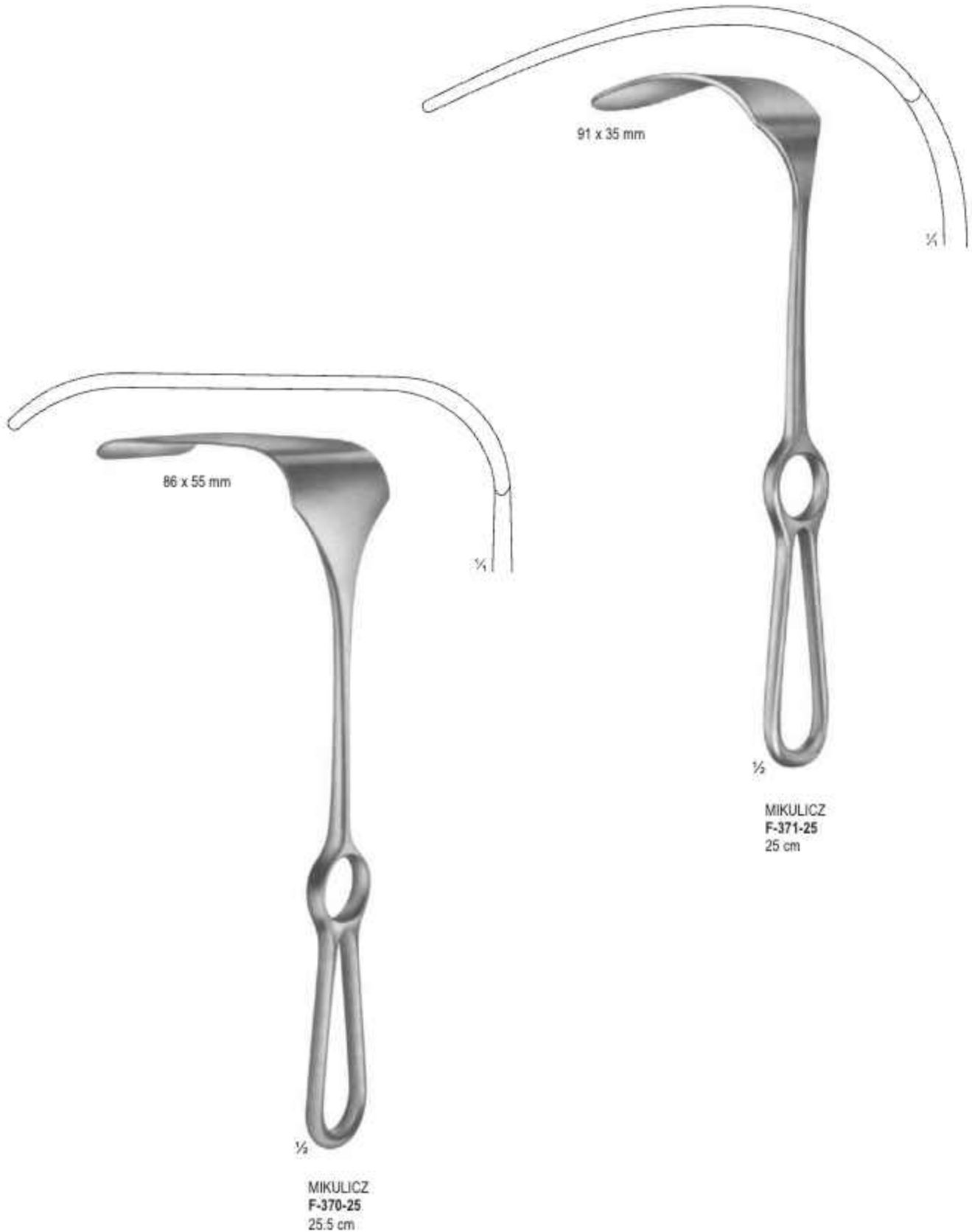

**SECTION
F**

**Retractors For Deep Surgery
(abdominal Retractors)**

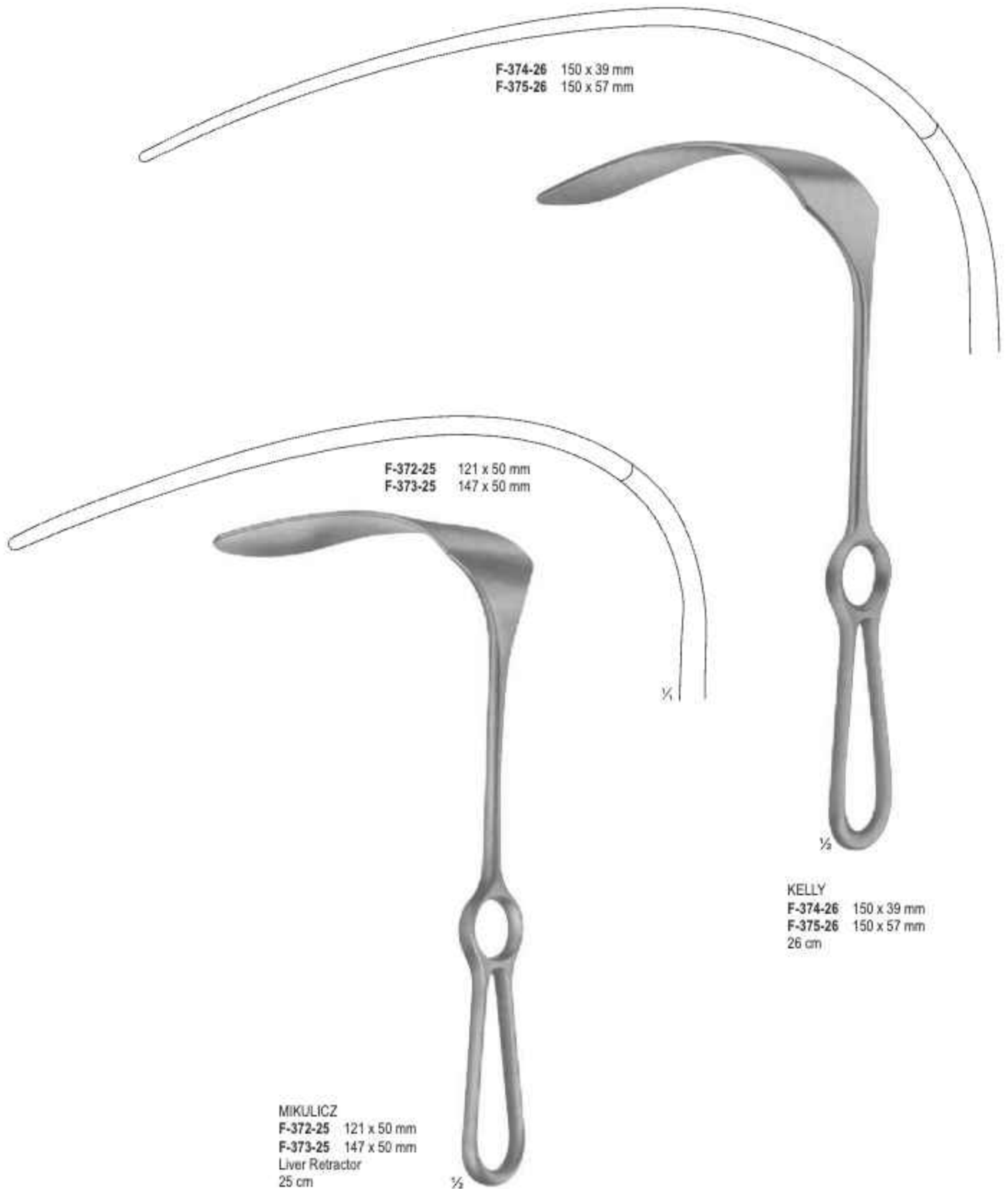

F-374-26 150 x 39 mm
F-375-26 150 x 57 mm

F-372-25 121 x 50 mm
F-373-25 147 x 50 mm

KELLY
F-374-26 150 x 39 mm
F-375-26 150 x 57 mm
26 cm

MIKULICZ
F-372-25 121 x 50 mm
F-373-25 147 x 50 mm
Liver Retractor
25 cm

**SECTION
F**

Abdominal Retractors



ROCHARD
F-383-31 - F-387-31
 31 cm
F-383-31 48 x 90 mm
F-384-31 48 x 105 mm
F-385-31 48 x 120 mm
F-386-31 48 x 135 mm
F-387-31 48 x 155 mm



F-388-00



DOYEN
F-389-28 - F-392-28
 28 cm
F-389-28 48 x 90 mm
F-390-28 48 x 105 mm
F-391-28 48 x 120 mm
F-392-28 48 x 135 mm



DOYEN-CHILD
F-393-22
 Fixation device
 22 cm



F-394-79
 Chain with
 weight (747 / 645g)
 79 cm

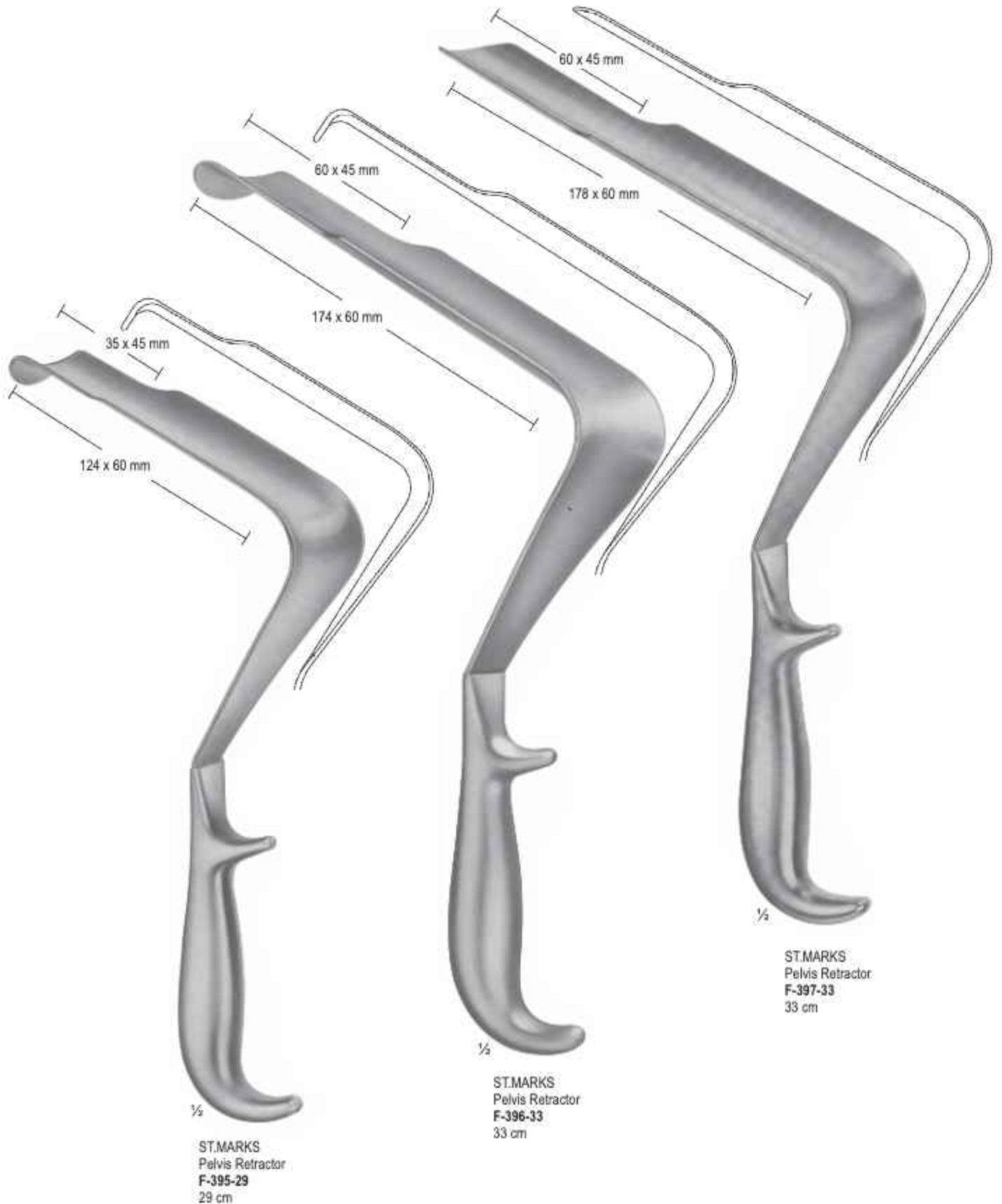

SECTION
F

Abdominal- And Intestinal Spatulas



BENELUX
surgical





SENN-GREEN
F-402-16 - F-403-16
16 cm



Fig. 1
F-402-16
20 X 6 mm



Fig. 2
F-403-16
10 X 6 mm



RAGNELL-DAVIS
F-404-15
15 cm



1/4
8 X 4.5 mm

15 X 5.5 mm



CUSHING
F-405-20
20.5 cm

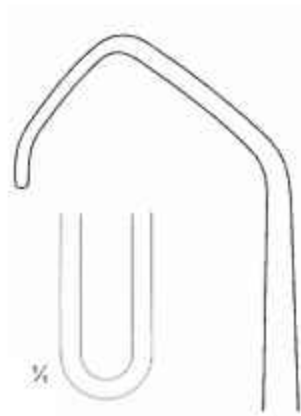

1/4

19 x 15 mm
19 x 15 mm



22 x 15 mm
22 x 15 mm

PARKER
F-406-14
14 cm



SECTION
F

Retractors

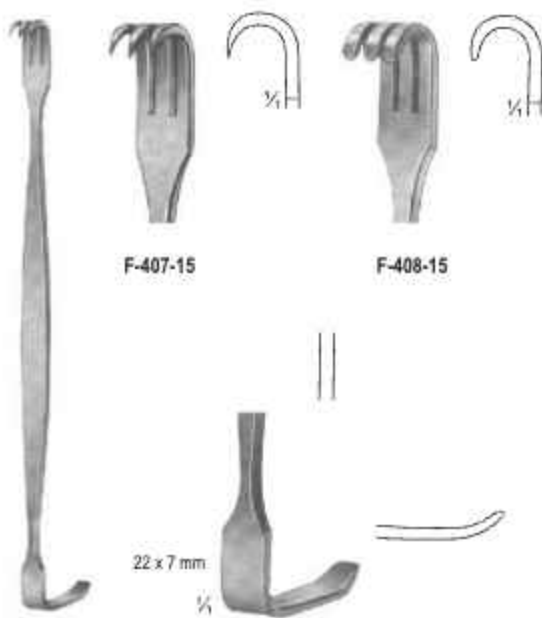

BABY-SENN-MILLER
F-407-15 - F-408-15
15.5 cm



SENN-MILLER
F-409-16
16.5 cm



COLLIN-HARTMANN
F-410-15
15 cm

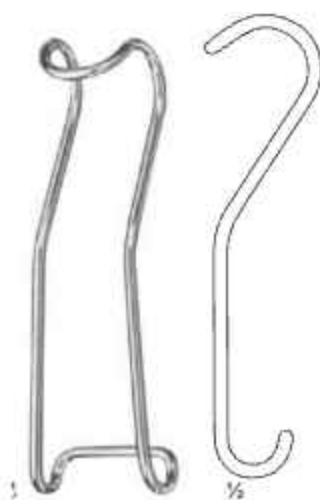

STERBERG
F-411-12 - F-414-14
F-411-12 12 cm
F-412-13 13 cm
F-413-13 13.5 cm
F-414-14 14 cm



26 x 10 mm
30 x 13 mm
30 x 10 mm
34 x 13 mm
FARABEUFG
F-415-12
12 cm

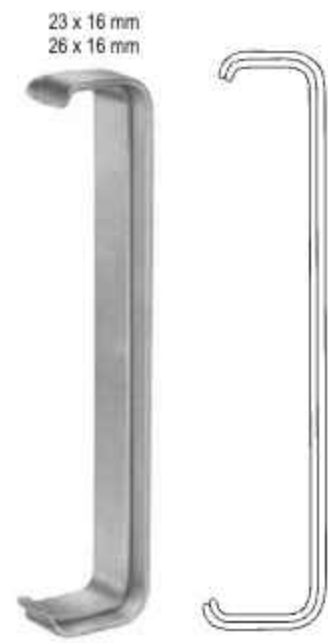

23 x 16 mm
26 x 16 mm
27 x 16 mm
30 x 16 mm
FARABEUFG
F-416-15
15 cm

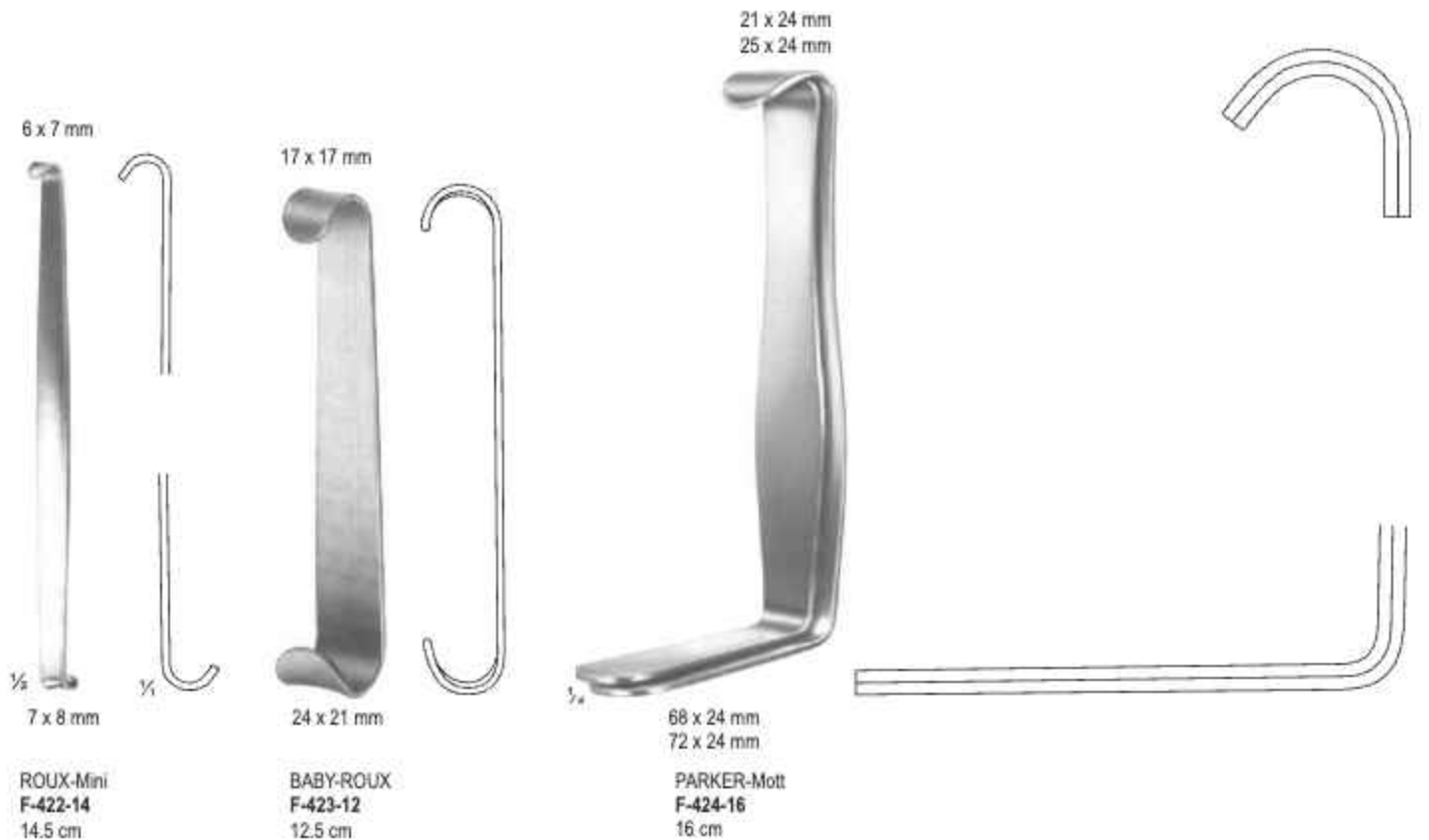
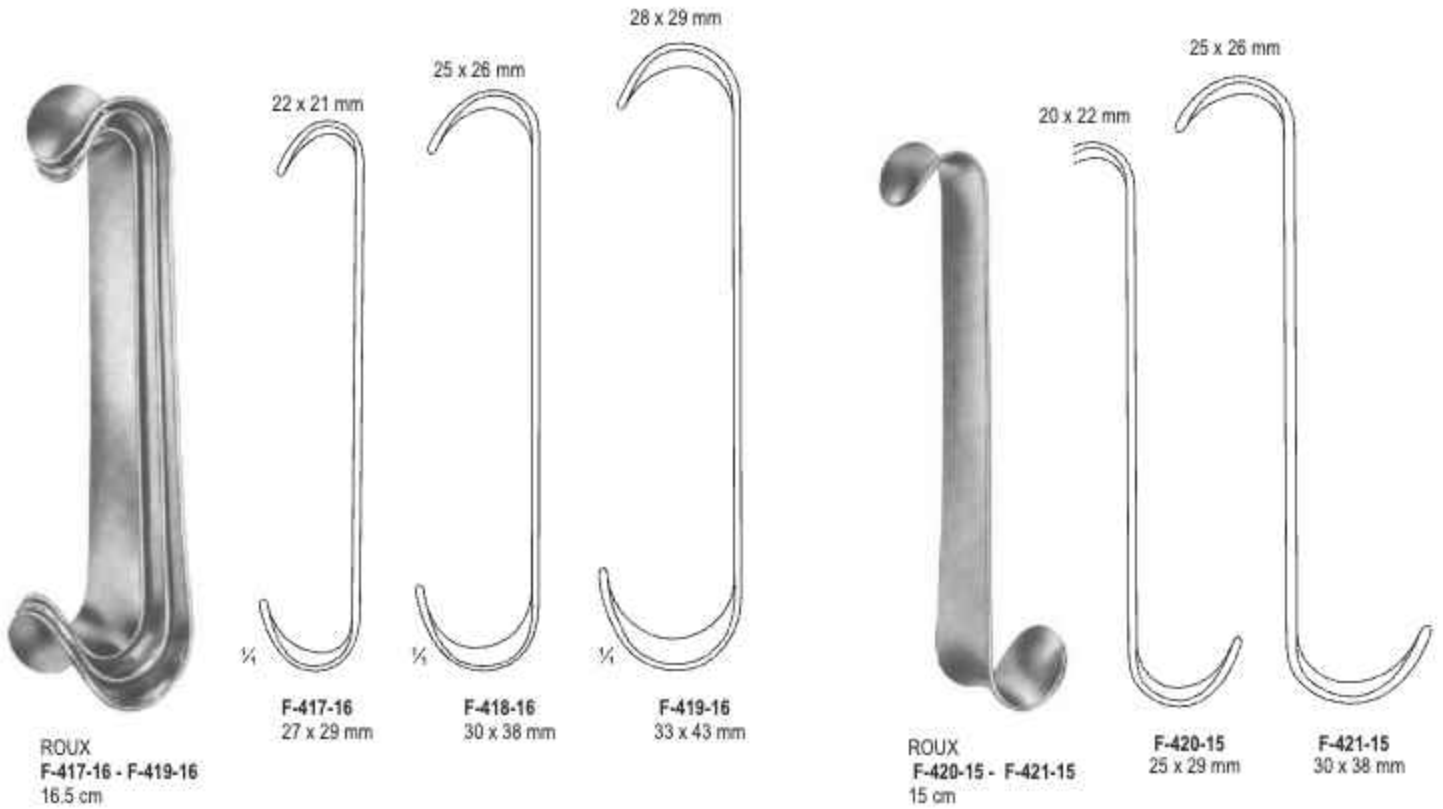

**SECTION
F**

Retractors

10 x 8 mm



12 x 11 mm

LUER
F-425-11
11 cm

11 x 4 mm



19 x 6 mm

CRILE
F-426-11
11 cm

10 x 12 mm



11 x 15 mm

ROSE
F-427-13
13 cm

21 x 14 mm
17 x 14 mm



28 x 16 mm
32 x 16 mm

COLLIN
F-428-15
15 cm



36 mm

1/2

CZERNY
F-429-17
17.5 cm



47 x 13 mm
41 x 13 mm

37 x 25 mm
42 x 25 mm

1/2

MATHIEU
F-430-20
20 cm



28 x 15 mm
22 x 15 mm

39 x 15 mm
43 x 15 mm

1/2

US-ARMY
F-431-22
22 cm



BOSE
F-432-60
60 mm



FINSEN
F-433-50
50 mm



FINSEN
F-434-70
70 mm



FINSEN modif.
F-435-75
75 mm



F-436-45
45 mm



F-437-55
55 mm



MUELLER
F-438-65
65 mm



ALM
F-439-07 7 cm
F-440-10 10 cm



F-439-07



F-440-10



JANSEN
F-441-00
100 mm



JANSEN
F-442-00
100 mm

SECTION
F

Self-retaining Retractors



WEITLANER
Sharp
F-443-11
11 cm



WEITLANER
Semi-Sharp
F-444-11
11 cm



WEITLANER
Blunt
F-445-11
11 cm



WEITLANER
Sharp
F-446-13
13 cm



WEITLANER
Semi-Sharp
F-447-13
13 cm



WEITLANER
Blunt
F-448-13
13 cm



ADSON-BABY
Blunt
F-449-14
14 cm

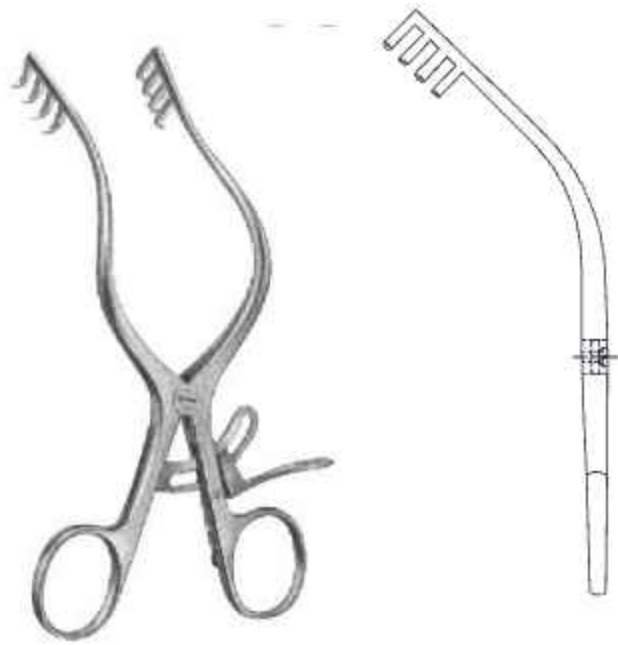

MOLLISON
Sharp
F-450-15
15.5 cm



MAYO-ADAMS
F-451-16
16.5 cm



TRAVERS
F-452-21
21.5 cm

**SECTION
F**

Self-retaining Retractors

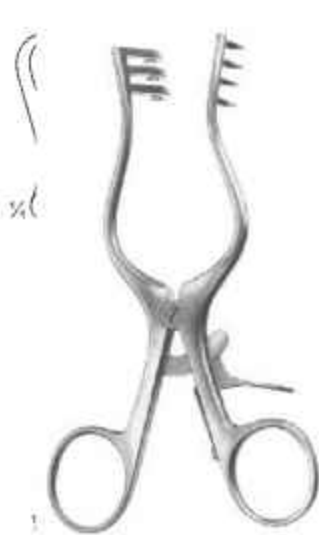

WEITLANER
Sharp
F-453-13
13 cm

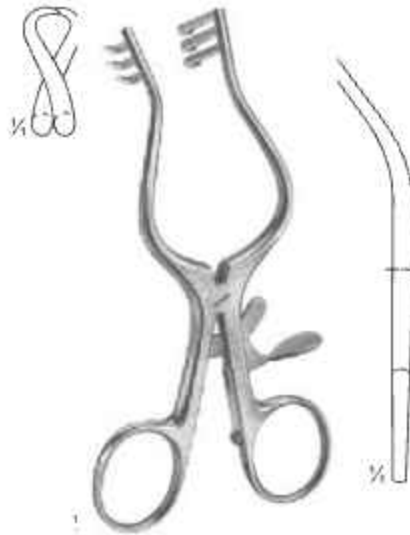

WULLSTEIN
Sharp
F-454-13
13 cm

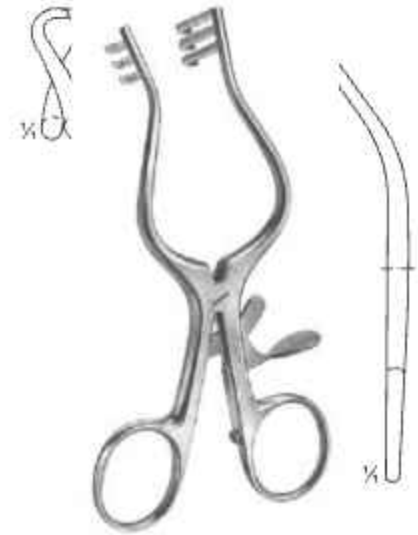

WULLSTEIN
Blunt
F-455-13
13 cm



WEITLANER
Sharp
F-456-16
16.5 cm



PLESTER
Blunt
F-457-11
11 cm

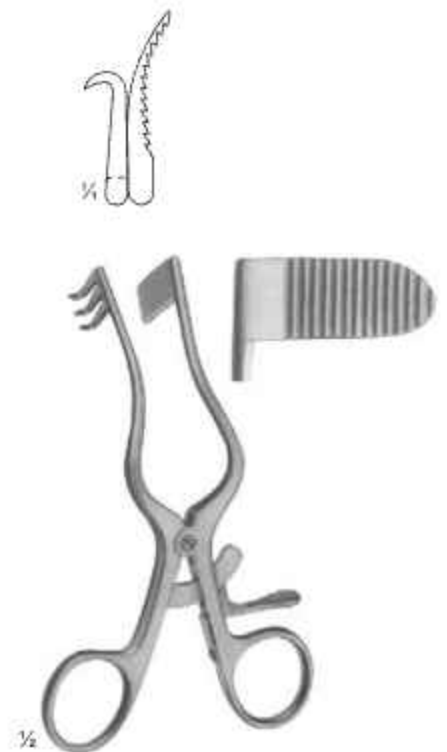

PERKINS
F-458-13
13 cm



HENLEY
Complete with 3 Central Blades
F-459-16 - F-461-16
16.5 cm



Blades
F-459-16
19 X 17 mm



Blades
F-460-16
25 X 17 mm



Blades
F-461-16
32 X 17 mm

SECTION
F

Self-retaining Laminectomy Retractors

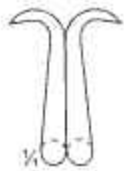

ANDERSON-ADSON
Sharp
F-462-19
19 cm



NORFOLK and
NORWICH
Blunt
F-463-22
22 cm



ADSON
Sharp
F-464-26
26.5 cm



Sharp



Semi-Sharp



Semi-Sharp

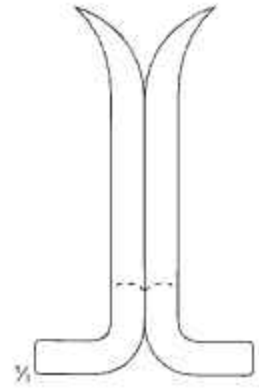

Sharp



BECKMANN-ADSON
Sharp
F-465-31
31 cm



BECKMANN-ADSON
Semi-Sharp
F-465-31
31 cm



ADSON
Semi-Sharp
F-466-32
32 cm



BECKMANN-EATON
Sharp
F-467-32
32 cm

**SECTION
F**

Special Retractors



JOLL (FRIEDMAN)
F-468-15
Thyroid and Vaginal Retractor
15.5 cm

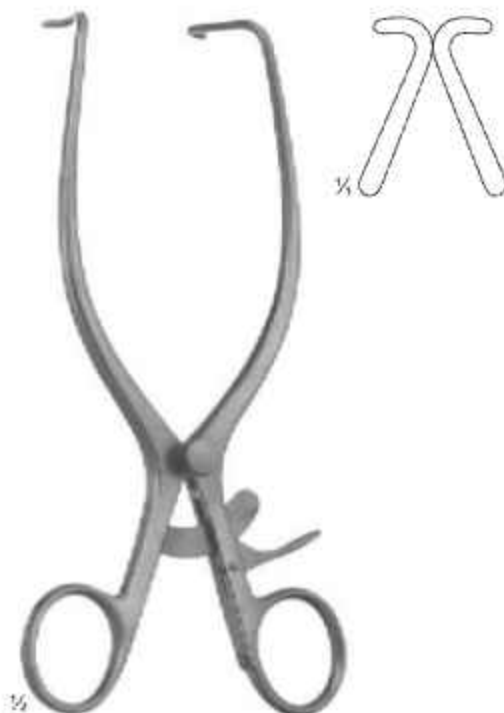

JACKSON BURROWS
F-469-18
Retractor, blunt
18.5 cm



GELPI
F-470-13
13.5 cm

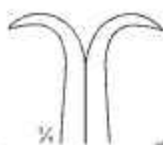

GELPI
F-471-17
17.5 cm

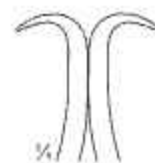

DE BAKEY
F-472-14
14.5 cm

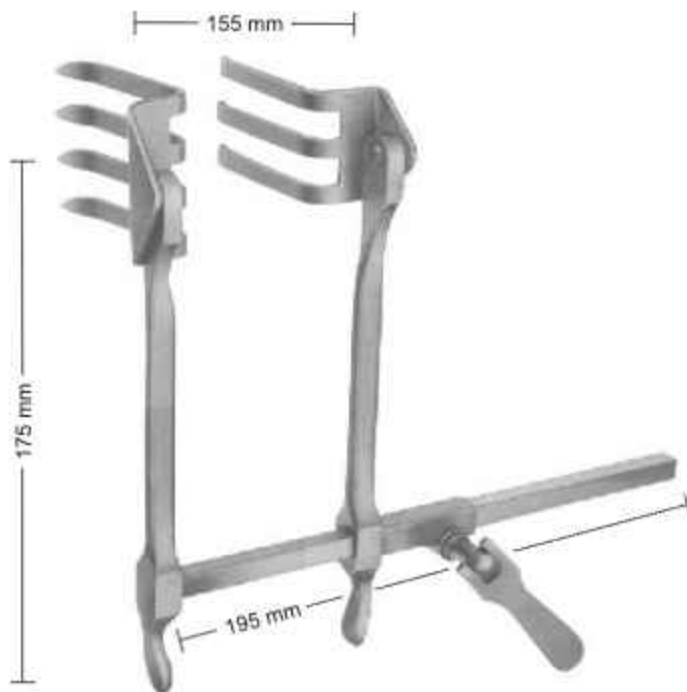

SCOVILLE-RICHTER
F-473-00 - F-476-00
Retractor with 1 pair
blades reversible type.
The Retractor bar and
shanks may be easily
rotated 180° when
blades are in site.



F-473-00
62 x 52 mm 62 x 37 mm
PR= Pair



F-474-00
47 x 51 mm



F-475-00
30 x 40 mm



F-476-00
37 x 62 mm

**SECTION
F**

Retractors For Cervical Spine



CLOWARD modif.
Spreader Only
F-477-16 - F-486-16

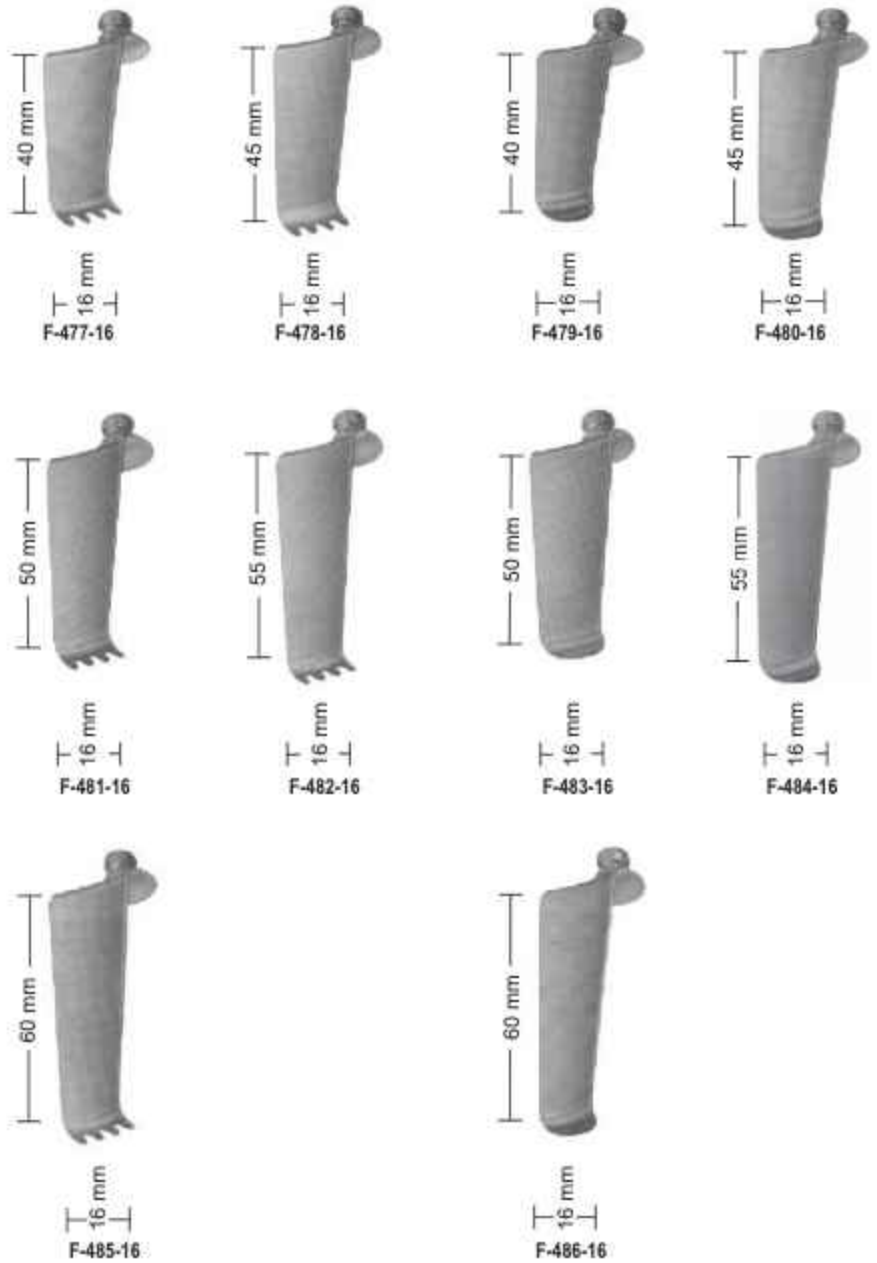



BABY-COLLIN
F-487-20 20 cm
complete, with 2 pair of lateral blades
Ref. F-487-20 (18 X 40 mm) and (27 X 40mm)
Spreading 80 mm



COLLIN
F-488-24 24 cm
complete Ref. F-488-24 (38 X 60 mm))
Spreading 80 mm



Central Blade
F-489-22
F-490-22
F-491-31

F-489-22 22.5 cm
complete, with 1 pair of lateral blades
Ref. F-489-22 (38 X 60 mm) and central blade
(38 X 55 mm) Spreading 85 mm

F-490-22 22.5 cm
complete, with 1 pair of lateral blades
Ref. F-490-22 (45 X 80 mm) and central blade
(50 X 75 mm) Spreading 80 mm

F-491-31 31 cm
complete, with 1 pair of lateral blades
Ref. F-491-22 (60 X 80 mm) and central blade
(60 X 75 mm) Spreading 130 mm

COLLIN
F-489-22 - F-491-31
F-489-22 22.5 cm
F-490-22 22.5 cm
F-491-31 31 cm

**SECTION
F**

Abdominal Retractors

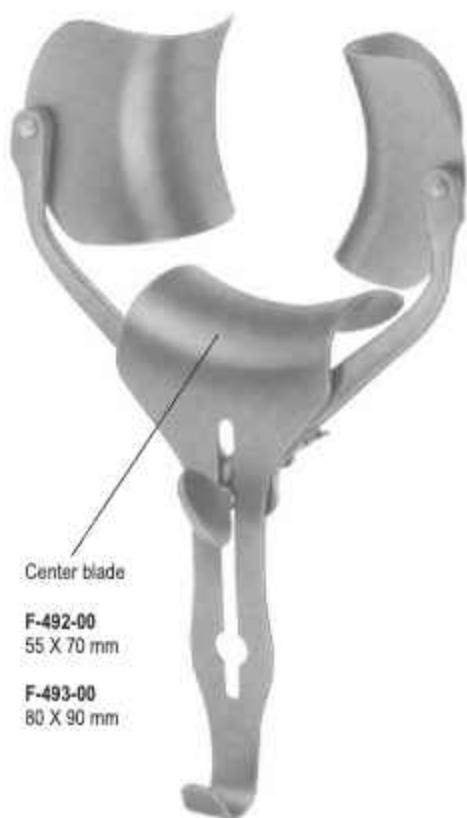

Center blade

F-492-00
55 X 70 mm

F-493-00
80 X 90 mm

F-492-00
Ricard complete, with 1 pair of lateral blades
(60 X 80 mm) and Center blade (55 X 70)

F-493-00
Ricard complete, with 1 pair of lateral blades
(72 X 85 mm) and Center blade (80 X 90)

F-494-00
Spreader Only



Lateral blades
F-495-00

F-496-00
18 X 40 mm

F-497-00
27 X 40 mm

F-498-00
38 X 60 mm

F-499-00
40 X 80 mm

F-500-00
45 X 80 mm

F-501-00
60 X 80 mm

RICARD
F-492-00 - F-501-00



Lateral blades

F-504-00
(59 X 80 mm)

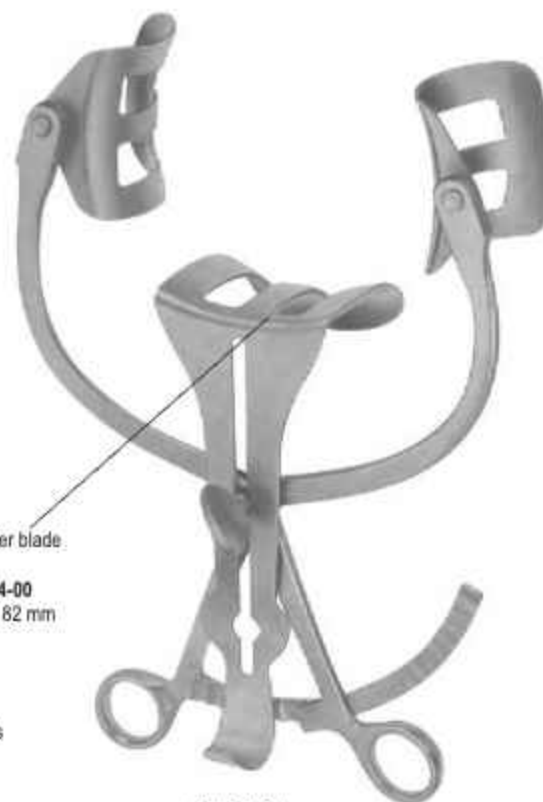

Center blade

F-504-00
74 X 82 mm

F-502-00
Holzbach complete, with 1 pair of lateral blades
(59 X 80 mm) and Center blade (74 X 82)
Spreading 275 mm

F-503-00
Spreader only

HOLZBACH
F-502-00 - F-504-00



GOSSET-BABY
F-505-12
12.5 cm
Lateral blades (40 X 30 mm deep)
Spreading 120 mm



BALFOUR-BABY
F-506-00
Lateral blades 27 mm deep
Center blade 21x24 mm

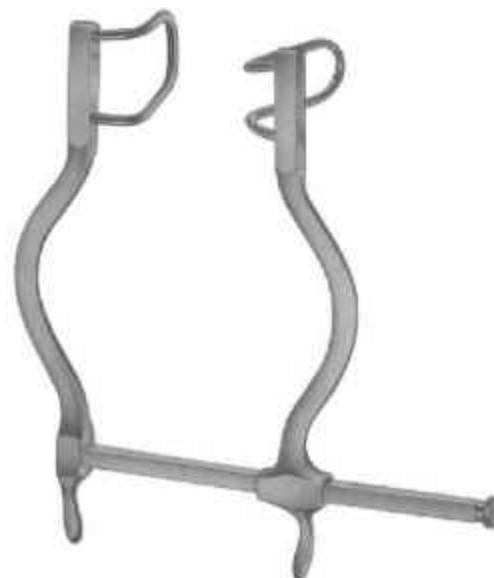

GOSSET
F-507-18
18.5 cm
Lateral blades (63 X 65 mm deep)
Spreading 140 mm



GOSSET
F-508-16
16.5 cm
Lateral blades (63 X 35 mm deep)
F-509-16 1 Center blade (60 x 56 mm)
Spreading 160 mm



HERTZLER
F-510-00
Blades 20 X 25 mm

**SECTION
F**

Abdominal Retractors

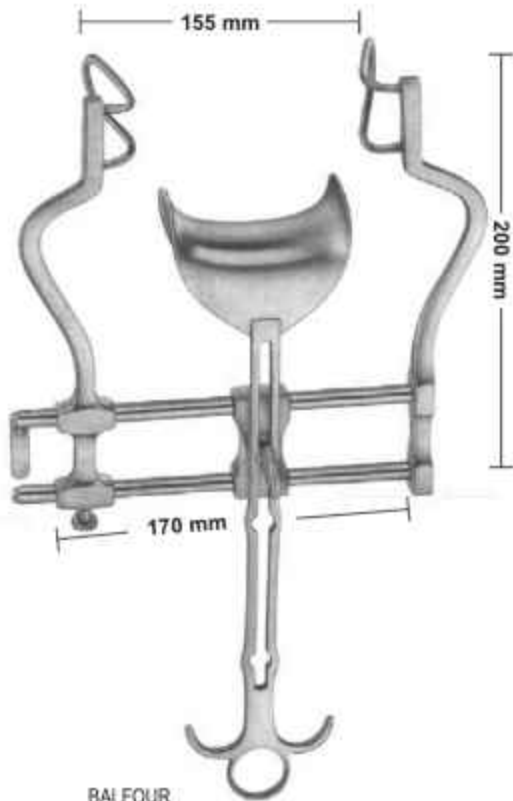

**BALFOUR
F-511-60**
Lateral blades 60 mm deep
Center blade 47 x 80 mm

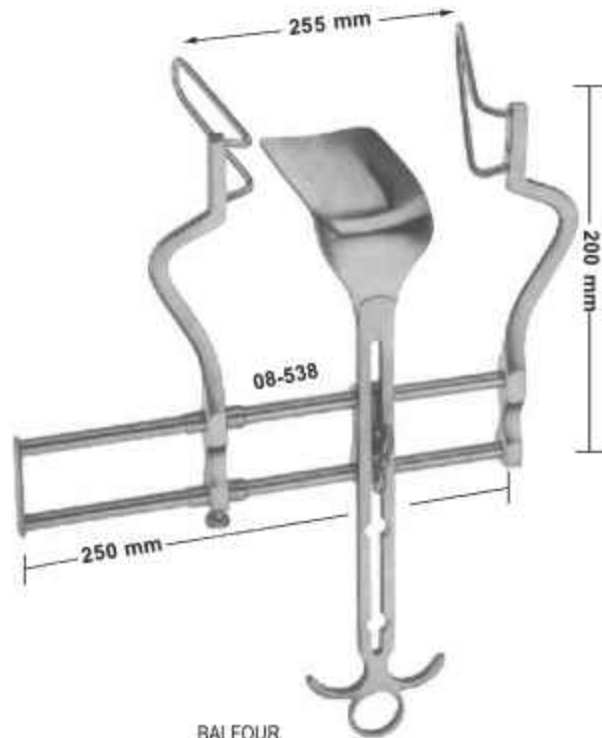

**BALFOUR
F-512-105**
Lateral blades 105 mm deep
Center blade 107x59 mm



F-513-00
Center blade only
54x80 mm

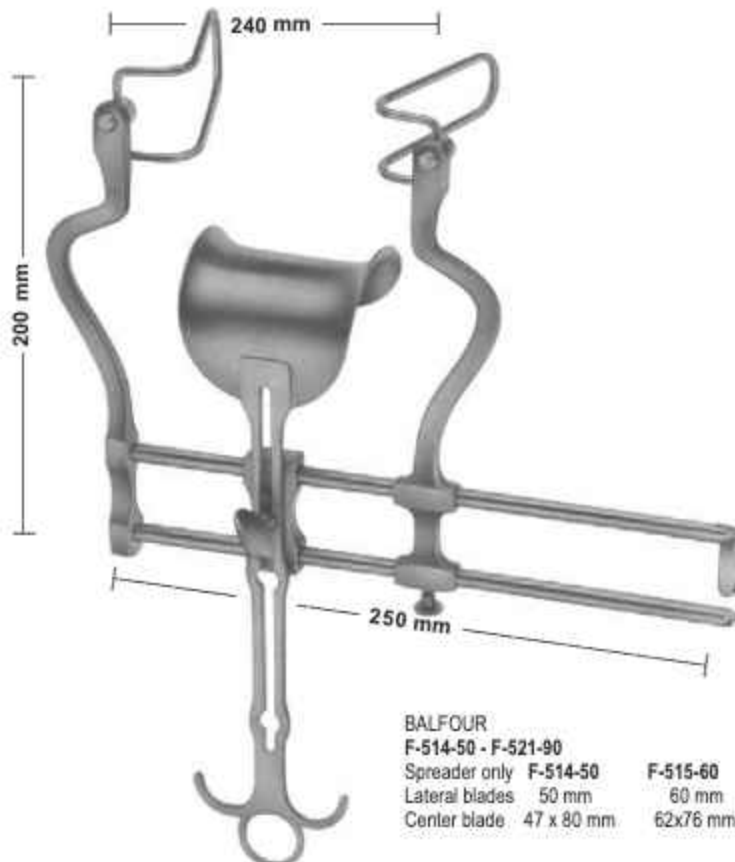

**BALFOUR
F-514-50 - F-521-90**
Spreader only

| | | | |
|-------------------------|-----------------|-----------------|-----------------|
| F-514-50 | F-515-60 | F-516-75 | F-517-90 |
| Lateral blades 50 mm | 60 mm | 75 mm | 90 mm |
| Center blade 47 x 80 mm | 62x76 mm | 80x80 mm | 80x80 mm |



Sales Unit of blades.PR = pair

Lateral blades
F-518-50 50 mm deep
F-519-60 60 mm deep
F-520-75 75 mm deep
F-521-90 90 mm deep

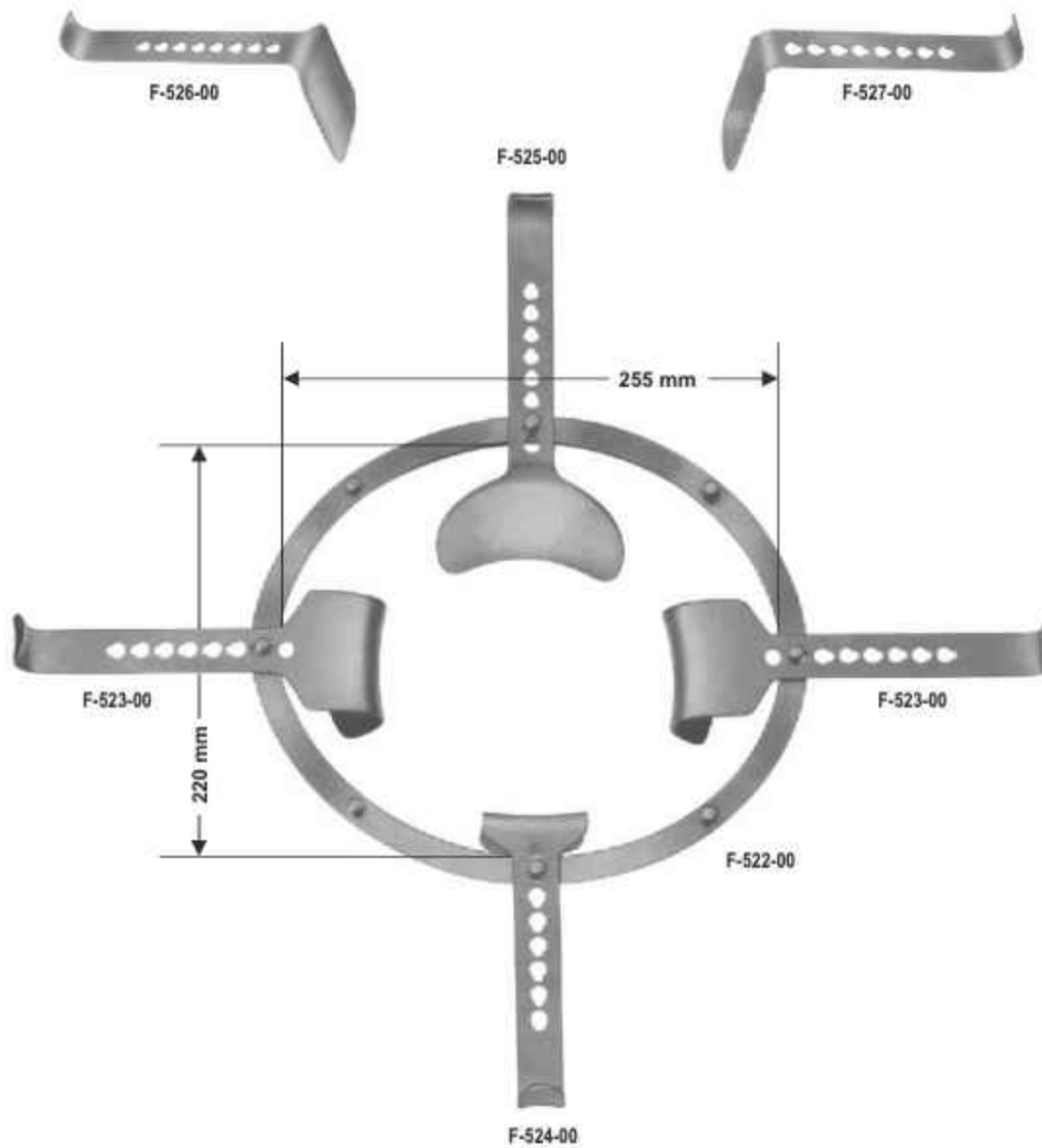

- SEMM
F-522-00 - F-527-00
consisting of:
- F-522-00 1 frame 225 x 220 mm
 - F-523-00 2 blades 46 x 64 mm
 - F-524-00 1 blade 53 x 54 mm
(for bladder)
 - F-525-00 1 blade 82 x 97 mm
(for intestine)
 - F-526-00 1 blade 98 x 51 mm
(for intestine)
 - F-527-00 1 blade, narrow
107 x 36 mm

**SECTION
F**

Abdominal Retractors

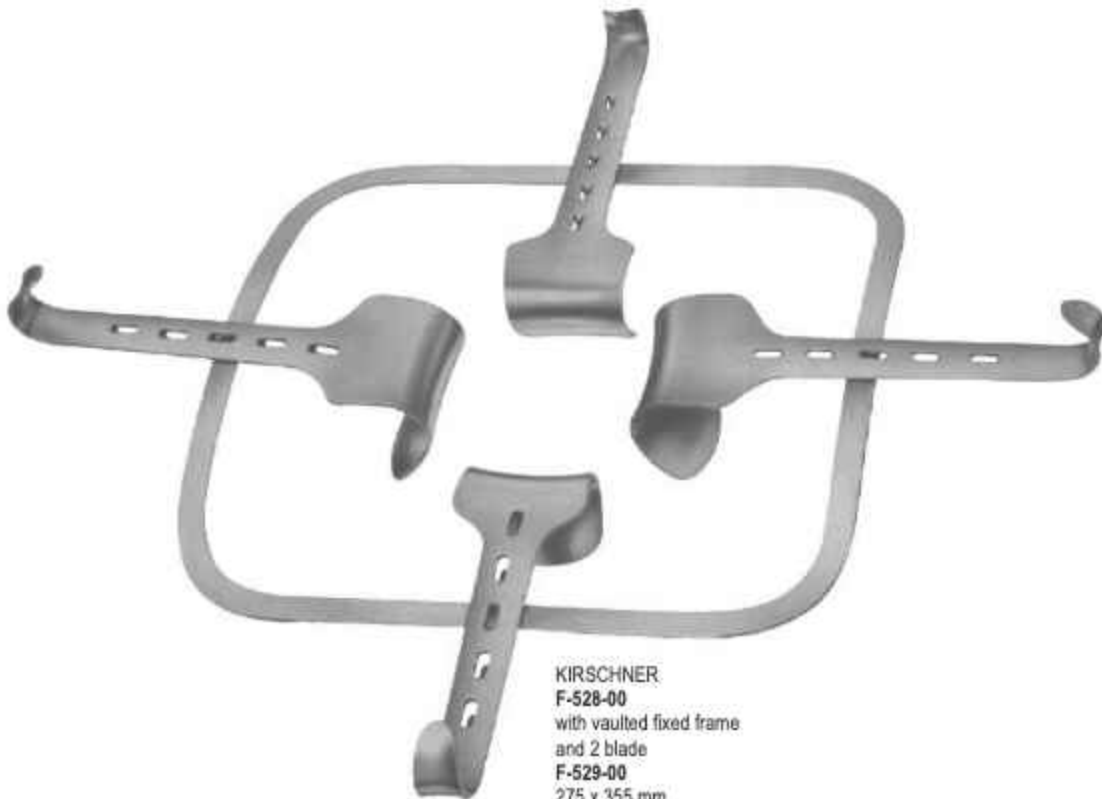

**KIRSCHNER
F-528-00**
with vaulted fixed frame
and 2 blade
F-529-00
275 x 355 mm
Frame only, over-sized
F-530-00
295 x 275 mm
Frame only



**KIRSCHNER
F-531-00**
64 x 80 mm



**KIRSCHNER-BALFOUR
F-532-00**
80x 82 mm



**KIRSCHNER
F-533-00 - F-535-00**
F-533-00 90x 69mm
F-534-00 92x 95mm
F-535-00 78x 58mm



**KIRSCHNER
F-536-00 - F-538-00**
F-536-00 108x42mm
F-537-00 91x 55mm
F-538-00 121x 55mm

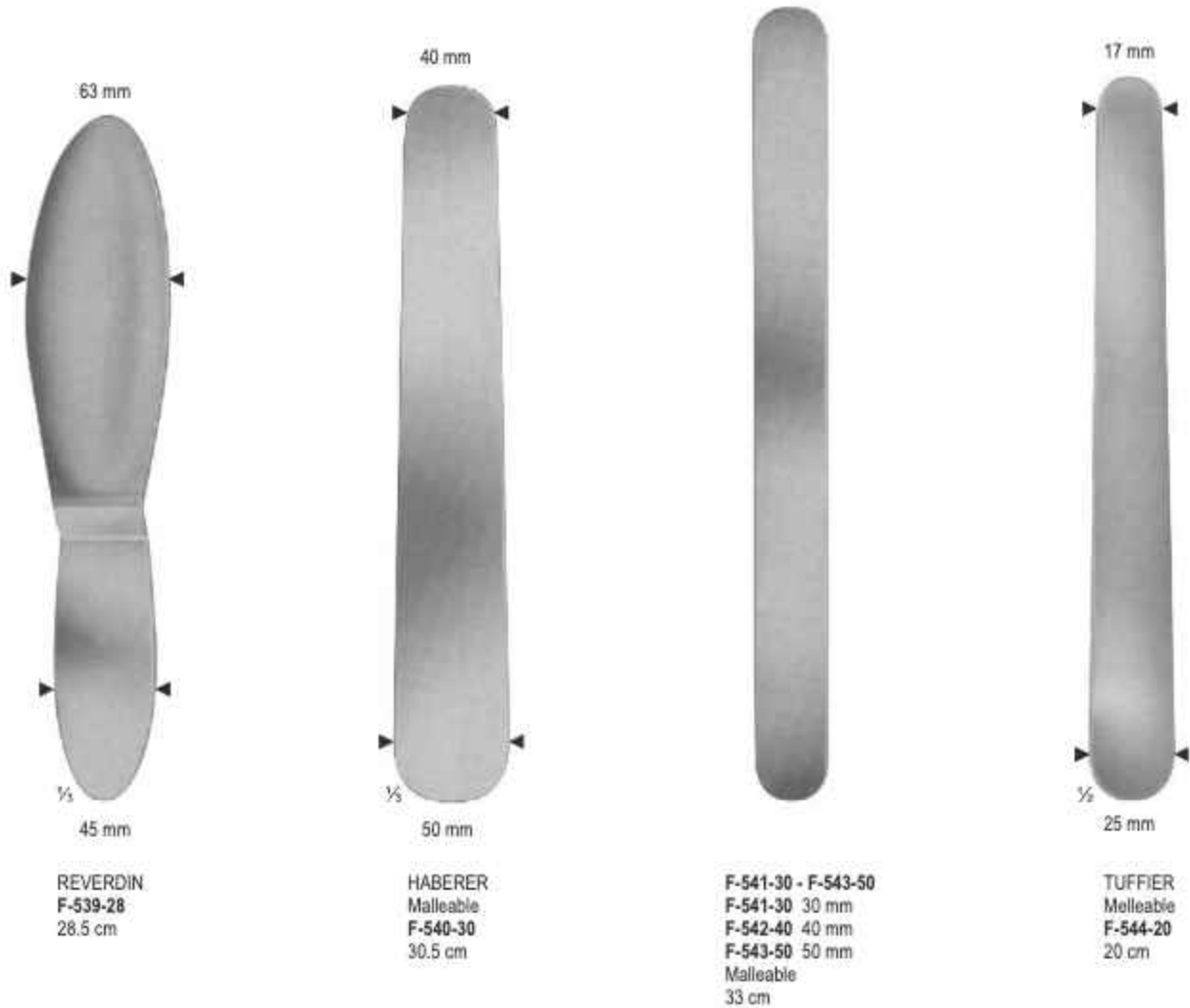



BENELUX
s u r g i c a l

Page 181-185

SECTION

G

- Probes
- Probes - Spatulas - Cotton Applicators
- Cotton Applicators
- Clip Applying Forceps - Suture Set



G-100-13 - G-102-16
G-100-13 13 cm
G-101-14 14.5 cm
G-102-16 16 cm
Directors



DOYEN
G-103-14
14.5 cm
Directors



NELATON
G-104-16
16 cm
Directors



G-105-14
Director with tip
Diam. Of tip 3,3 mm
14 cm

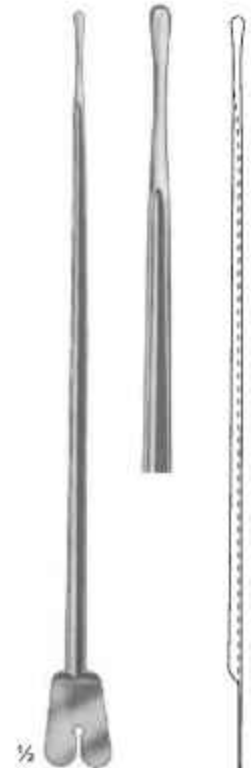

BRODIE
G-106-20
Director with tip,
Diam. Of tip 3,5 mm
20 cm



LOCKHART-MUMMERY
G-107-16
16.5 cm



LOCKHART-MUMMERY
G-108-16
16.5 cm

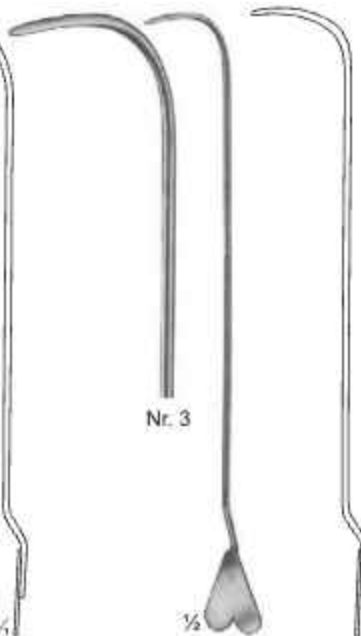

LOCKHART-MUMMERY
G-109-16
16.5 cm

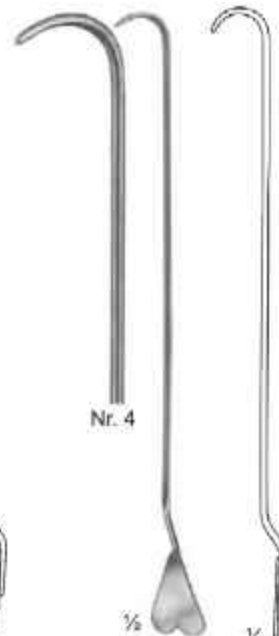

LOCKHART-MUMMERY
G-110-16
16.5 cm



G-111-19
Director with wire
loop, malleable
19 cm

SECTION
G

Probes



BENELUX
surgical



PROBES
G-112-13 - G-114-16
G-112-13 13 cm
G-113-14 14 cm
G-114-16 16 cm
Probes with eye



PROBES
G-115-14
Myrtle leaf probe
14.5 cm

1.5 mm



PROBES
G-116-13 - G-120-20
G-116-13 13 cm
G-117-14 14.5 cm
G-118-16 16 cm
G-119-18 18 cm
G-120-20 20 cm

2 mm



PROBES
G-121-00
Probes



PROBES
G-122-19
Double ended probe,
malleable, diam. of tips
3 mm with hole
19 cm



PROBES
G-123-25
Double ended probes,
tin, malleable,
diam. of tips
3.5 mm with hole
25 cm, 30 cm



PROBES
G-124-40
Double ended probes,
tin, malleable,
diam. of tips 4 mm
40 cm



PROBES
G-125-30 - G-127-30
G-125-30 1.5 mm
G-126-30 2 mm
G-127-30 2.5 mm
30 cm

∅ tip



STACKE
G-128-10
10 cm



KILLIAN
G-129-16
16.5 cm



G-130-16
16 cm



SEIFFERT
G-131-18
18 cm



BOWMAN
G-132-13
13 cm



SPATULA
G-133-14
14.5 cm



SPATULA
G-134-14
14.5 cm



G-135-11
Modell PICCOLO
Round Serrated
11 cm



G-136-11
Modell PICCOLO
Triangular Serrated end
11 cm



FARRELL
G-137-11
Round Serrated end
11 cm



LATHBURY-FARRELL
G-138-11
Triangular Serrated end
11 cm

**SECTION
G**

Cotton Applicators

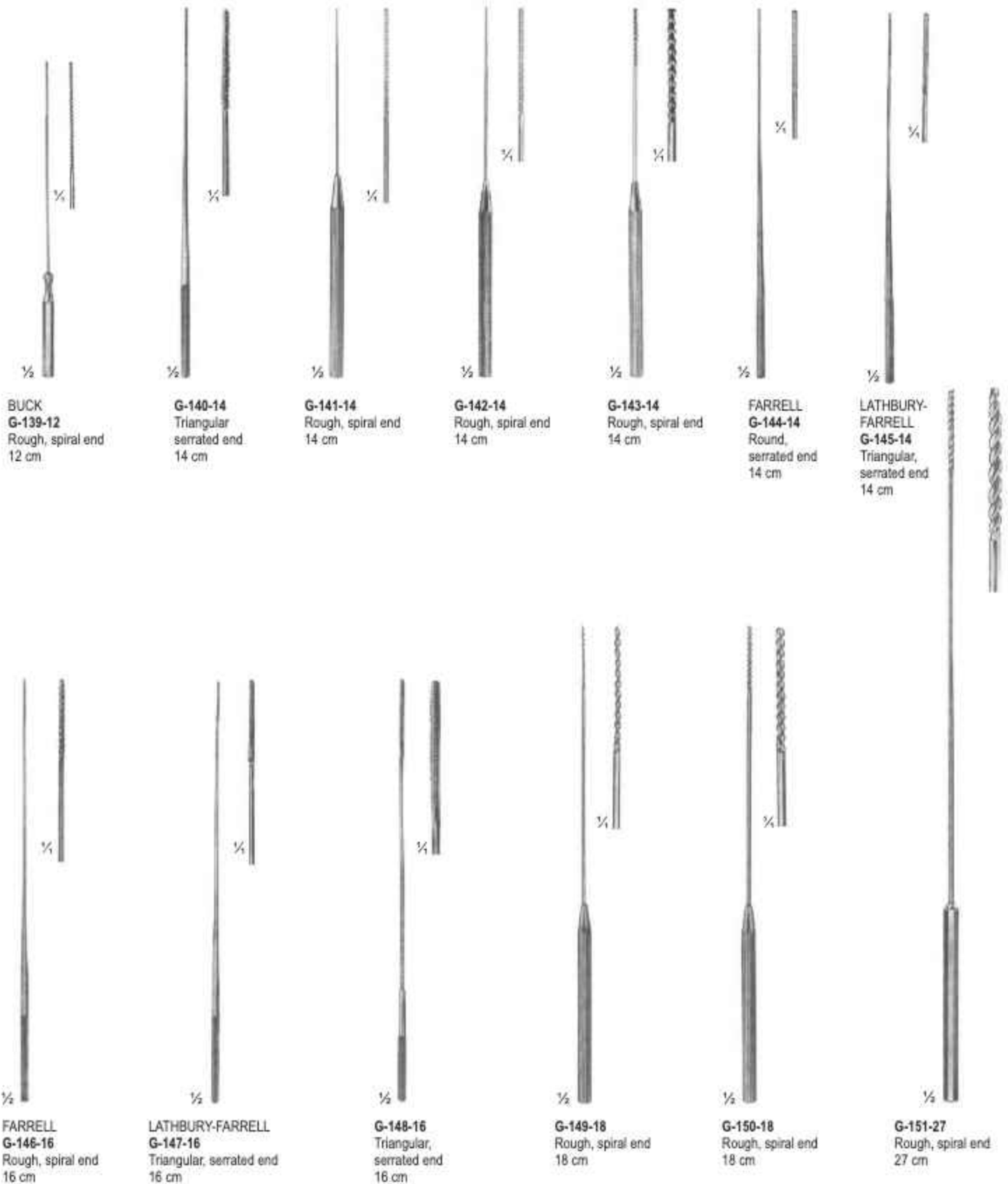



MICHEL
G-152-12
12.5 cm



HEGENBARTH
G-153-12
12 cm



WACHENFELDT
G-154-12
12 cm



WACHENFELDT
G-155-12
12 cm



MICHEL
G-156-12
12.5 cm



MICHEL modif.
G-157-13
13 cm



HEATH
G-158-13
13.5 cm



COLLIN
G-159-13
13.5 cm



BENELUX
s u r g i c a l

Page 181-185

SECTION

G

- Probes
- Probes - Spatulas - Cotton Applicators
- Cotton Applicators
- Clip Applying Forceps - Suture Set



G-100-13 - G-102-16
G-100-13 13 cm
G-101-14 14.5 cm
G-102-16 16 cm
Directors



DOYEN
G-103-14
14.5 cm
Directors



NELATON
G-104-16
16 cm
Directors



G-105-14
Director with tip
Diam. Of tip 3,3 mm
14 cm



BRODIE
G-106-20
Director with tip,
Diam. Of tip 3,5 mm
20 cm



LOCKHART-MUMMERY
G-107-16
16.5 cm



LOCKHART-MUMMERY
G-108-16
16.5 cm

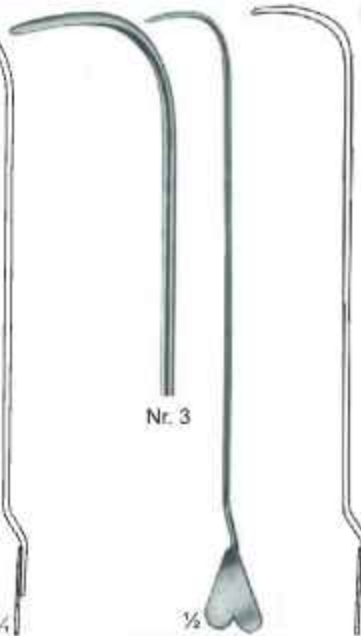

LOCKHART-MUMMERY
G-109-16
16.5 cm

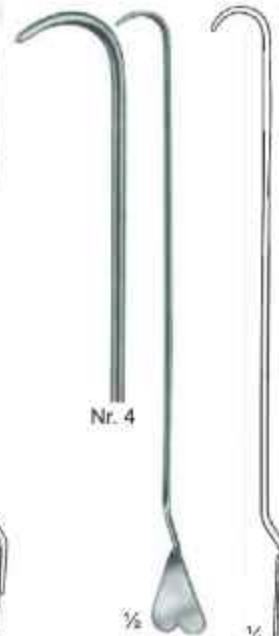

LOCKHART-MUMMERY
G-110-16
16.5 cm



G-111-19
Director with wire
loop, malleable
19 cm



PROBES
G-112-13 - G-114-16
G-112-13 13 cm
G-113-14 14 cm
G-114-16 16 cm
Probes with eye



PROBES
G-115-14
Myrtle leaf probe
14.5 cm



PROBES
G-116-13 - G-120-20
G-116-13 13 cm
G-117-14 14.5 cm
G-118-16 16 cm
G-119-18 18 cm
G-120-20 20 cm



PROBES
G-121-00
Probes



PROBES
G-122-19
Double ended probe,
malleable, diam. of tips
3 mm with hole
19 cm



PROBES
G-123-25
Double ended probes,
tin, malleable,
diam. of tips
3.5 mm with hole
25 cm, 30 cm



PROBES
G-124-40
Double ended probes,
tin, malleable,
diam. of tips 4 mm
40 cm



PROBES
G-125-30 - G-127-30
G-125-30 1.5 mm
G-126-30 2 mm
G-127-30 2.5 mm
30 cm



STACKE
G-128-10
10 cm



KILLIAN
G-129-16
16.5 cm



G-130-16
16 cm



SEIFFERT
G-131-18
18 cm



BOWMAN
G-132-13
13 cm



SPATULA
G-133-14
14.5 cm



SPATULA
G-134-14
14.5 cm



G-135-11
Modell PICCOLO
Round Serrated
11 cm



G-136-11
Modell PICCOLO
Triangular Serrated end
11 cm



FARRELL
G-137-11
Round Serrated end
11 cm



LATHBURY-FARRELL
G-138-11
Triangular Serrated end
11 cm

SECTION
G

Cotton Applicators

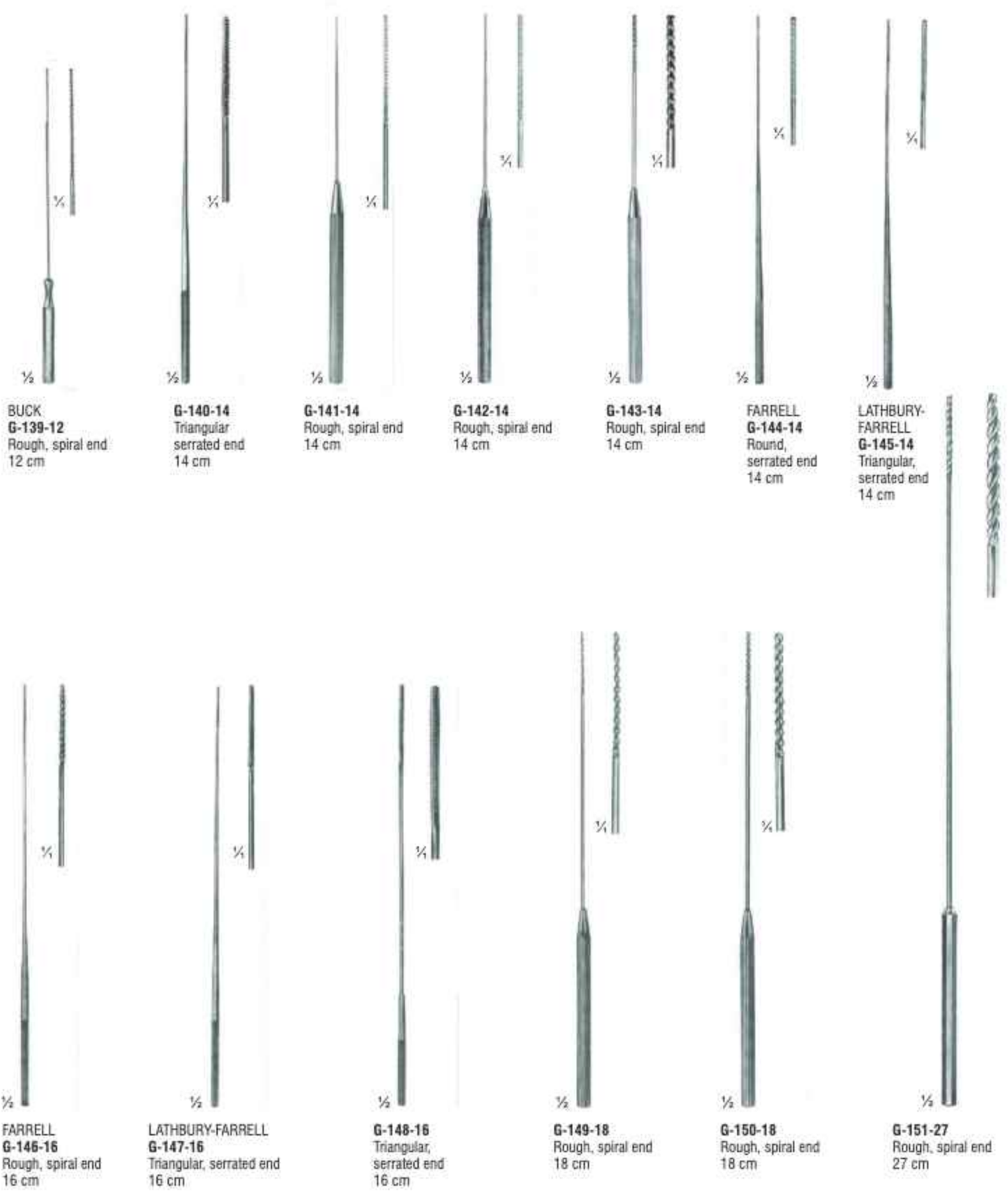

BUCK
G-139-12
Rough, spiral end
12 cm

G-140-14
Triangular
serrated end
14 cm

G-141-14
Rough, spiral end
14 cm

G-142-14
Rough, spiral end
14 cm

G-143-14
Rough, spiral end
14 cm

FARRELL
G-144-14
Round,
serrated end
14 cm

LATHBURY-FARRELL
G-145-14
Triangular,
serrated end
14 cm

FARRELL
G-146-16
Rough, spiral end
16 cm

LATHBURY-FARRELL
G-147-16
Triangular, serrated end
16 cm

G-148-16
Triangular,
serrated end
16 cm

G-149-18
Rough, spiral end
18 cm

G-150-18
Rough, spiral end
18 cm

G-151-27
Rough, spiral end
27 cm



BENELUX
s u r g i c a l

Page 186-196

SECTION

H

- Retractors For Cervical Vertebral Column
- Vacuum Currettes For Aspiration Lipectomy, Suction Instruments
- Suction Instruments
- Combined Suction and Irrigation Cannula



| | |
|----------|-------|
| H-100-08 | 8 CH |
| H-101-10 | 10 CH |
| H-102-12 | 12 CH |
| H-103-14 | 14 CH |
| H-104-16 | 16 CH |
| H-105-18 | 18 CH |

REDON
H-100-08 - H-105-18
threaded end
19.5 cm



| | |
|----------|-------|
| H-106-08 | 8 CH |
| H-107-10 | 10 CH |
| H-108-12 | 12 CH |
| H-109-14 | 14 CH |
| H-110-16 | 16 CH |
| H-111-18 | 18 CH |

REDON
H-106-08 - H-111-18
threaded end
14 cm



| | |
|----------|-------|
| H-112-08 | 8 CH |
| H-113-10 | 10 CH |
| H-114-12 | 12 CH |
| H-115-14 | 14 CH |
| H-116-16 | 16 CH |
| H-117-18 | 18 CH |

REDON
H-112-08 - H-117-18
threaded end
19.5 cm



| | |
|----------|-------|
| H-118-08 | 8 CH |
| H-119-10 | 10 CH |
| H-120-12 | 12 CH |
| H-121-14 | 14 CH |
| H-122-16 | 16 CH |
| H-123-18 | 18 CH |

REDON
H-118-08 - H-123-18
threaded end
19.5 cm

SECTION
H

Vacuum Currettes For Aspiration Lipectomy,
Suction Instruments



BIEMER
H-124-04 - H-129-14
H-124-04 \varnothing 4 mm
H-125-06 \varnothing 6 mm
H-126-08 \varnothing 8 mm
H-127-10 \varnothing 10 mm
H-128-12 \varnothing 12 mm
H-129-14 \varnothing 14 mm
 Currettes for aspiration lipectomy, graduated, slightly curved

BIEMER
H-130-04 - H-131-06
H-130-04 \varnothing 4 mm
H-131-06 \varnothing 6 mm
 Currettes for aspiration lipectomy, with three apertures, slightly curved malleable

BIEMER
H-132-08 - H-134-12
H-132-08 \varnothing 8 mm
H-133-10 \varnothing 10 mm
H-134-12 \varnothing 12 mm
 Currettes for aspiration lipectomy, with three apertures, slightly curved malleable

H-135-17
 For aspirating fluid from the excretory ducts of large glands and for keeping the operating area clear
 17 cm

H-136-15
 Trocar
 For puncturing
 15 cm

H-137-19
 For clearing large quantities of fluid
 19 cm



POOLE
H-138-24
24 cm
∅ 10 mm



POOLE
H-139-25
25 cm
∅ 8 mm



COLLEY
H-140-31
with perforated screw tip
31 cm
∅ 10 mm



COLLEY
H-141-31
with perforated screw tip
31 cm
∅ 7 mm



COLLEY
H-142-36
36 cm
∅ 8 mm



COLLEY
H-143-36
with perforated screw tip
36 cm
∅ 8 mm

**SECTION
H**

Retractors For Cervical Vertebral Column



**DE-BAKEY
H-144-16**
with finger cut-off
and stylet
16 cm



**NUBOER
H-145-21**
round opening
21 cm
∅ 10 mm



**NUBOER
H-146-21**
oval opening
21 cm
∅ 6 mm



**FRAZIER
H-147-24**
24 cm
∅ 3.3 mm



**ADSON
H-148-20**
20 cm
∅ 4 mm



**COUPLAND
H-149-09 - H-152-09**
with tube connector
17 cm

H-149-09
9 cm
∅ 1.5 mm

H-150-09
9 cm
∅ 2 mm

H-151-09
9 cm
∅ 2.5 mm

H-152-09
9 cm
∅ 3.5 mm



H-153-09
9 cm
∅ 3 mm

H-154-09
9 cm
∅ 3.5 mm

H-155-09
9 cm
∅ 4.3 mm

**BYRD
H-153-09 - H-155-09**
with tube connector
17 cm



**COGSWELL
H-156-24**
with finger cut-off
24.5 cm
∅ 3.8 mm

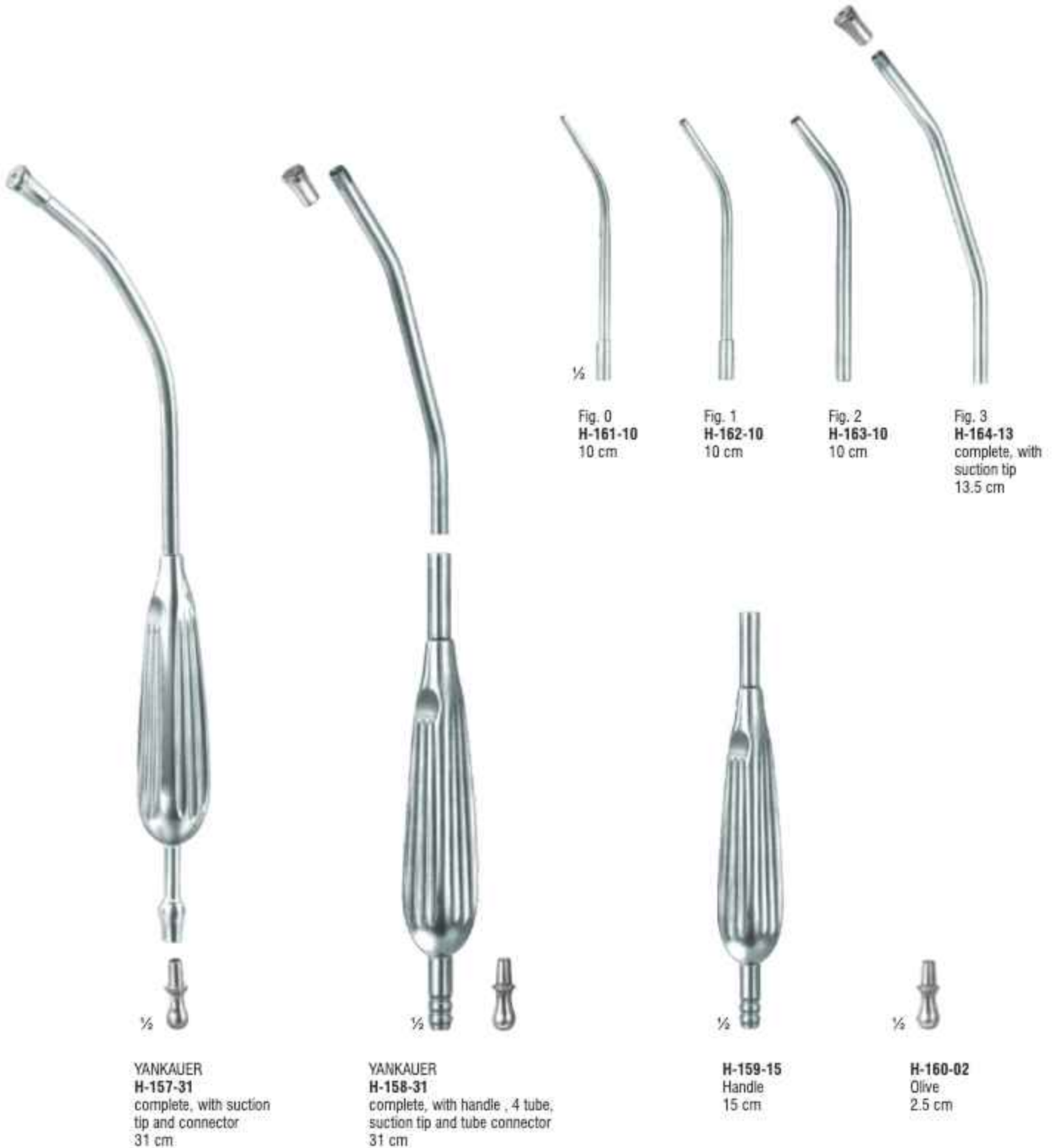

SECTION
H

Suction Instruments

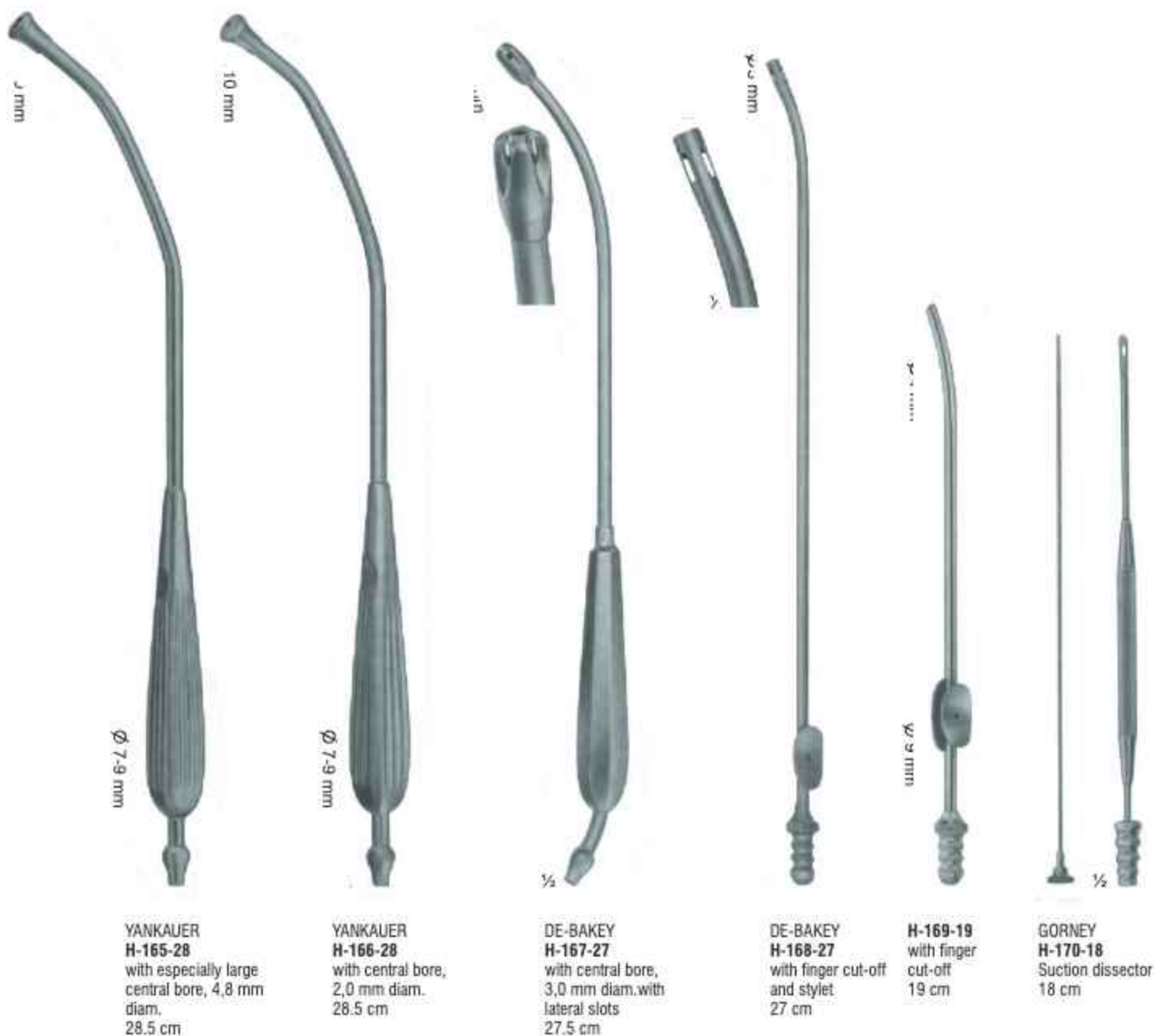



H-171-01 ø 1.5 mm
H-172-02 ø 2 mm
H-173-02 ø 2.5 mm
H-174-03 ø 3 mm

PLESTER
H-171-01 - H-174-03
with finger cut-off and
stylet, thumb piece
parallel to curved, with
LUER hub
19.5 cm



H-175-02 ø 2 mm
H-176-02 ø 2.5 mm
H-177-03 ø 3 mm
H-178-04 ø 4 mm
H-179-05 ø 5 mm

FERGUSON
H-175-02 - H-179-05
with finger cut-off and
stylet, thumb piece
90° to curved, with
LUER hub
18 cm



FERGUSON
H-180-04 4 mmø
insulated, with finger cut-off
and stylet, thumb piece 90°
to curved, with LUER
18 cm



FRAZIER
H-181-03 - H-182-05
H-181-03 ø 3 mm
H-182-05 ø 5 mm
insulated, with finger
cut-off and stylet, thum
piece 90° to curved,
with LUER hub
18 cm

H-183-19 19.5 cm ø 2 mm
H-184-19 19.5 cm ø 2.3 mm
H-185-19 19.5 cm ø 3 mm
H-186-19 19.5 cm ø 3.3 mm
H-187-19 19.5 cm ø 3.6 mm
H-188-19 19.5 cm ø 4 mm
H-189-19 19.5 cm ø 5 mm



IER
H-189-19
3 mm



H-190-02 ø 2 mm
H-191-02 ø 2.6 mm
H-192-03 ø 3.3 mm
H-193-04 ø 4 mm

POPPE
H-190-02 - H-193-04
working length
90 mm



H-194-18
5.0 mm diam., Tip
6.5 mm wide, Nasal
suction tube, with
LUER hub
18 cm



H-195-04 - H-196-05
H-195-04 ø 4.5 mm
H-196-05 ø 5.5 mm
Nasal suction
tubes
17.5 cm



H-197-20 - H-198-20
H-197-20 4 mm wide
H-198-20 5 mm wide
Suction raspatories,
sharp, bayonet-shaped,
with stylet
20 cm



LOPEZ-REINKE
H-199-23
Tonsil dissector with
suction device
23.5 cm

SECTION H

Suction Instruments



WULLSTEIN
H-200-16
Suction tube, conical, silver, olive
with LUER hub
16 cm

∅1,75 mm

∅3 mm

1/4

∅8 mm

WULLSTEIN
H-201-16 1.5 mm
H-202-16 2 mm
Suction tube, cylindrical, silver, with
stylet with LUER hub
16 cm



1/4

∅8 mm

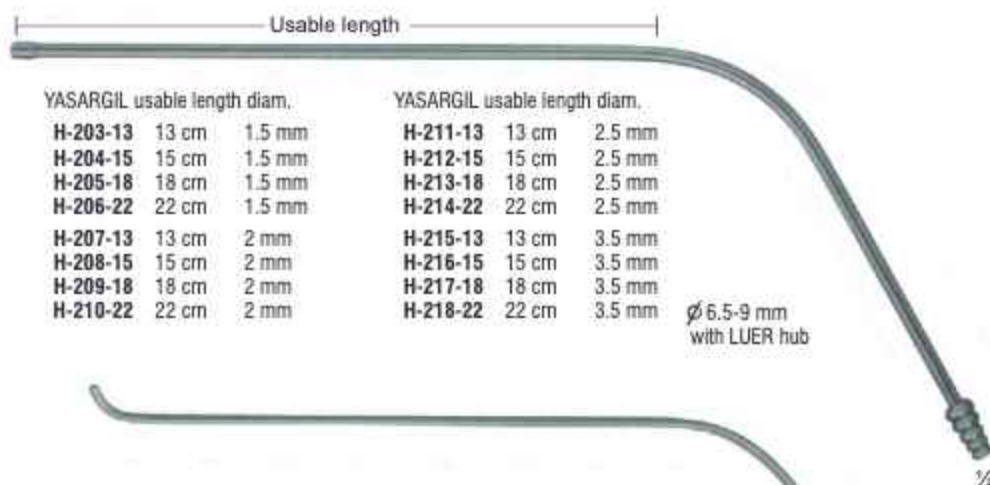

Usable length

YASARGIL usable length diam.

| | | |
|-----------------|-------|--------|
| H-203-13 | 13 cm | 1.5 mm |
| H-204-15 | 15 cm | 1.5 mm |
| H-205-18 | 18 cm | 1.5 mm |
| H-206-22 | 22 cm | 1.5 mm |
| H-207-13 | 13 cm | 2 mm |
| H-208-15 | 15 cm | 2 mm |
| H-209-18 | 18 cm | 2 mm |
| H-210-22 | 22 cm | 2 mm |

YASARGIL usable length diam.

| | | |
|-----------------|-------|--------|
| H-211-13 | 13 cm | 2.5 mm |
| H-212-15 | 15 cm | 2.5 mm |
| H-213-18 | 18 cm | 2.5 mm |
| H-214-22 | 22 cm | 2.5 mm |
| H-215-13 | 13 cm | 3.5 mm |
| H-216-15 | 15 cm | 3.5 mm |
| H-217-18 | 18 cm | 3.5 mm |
| H-218-22 | 22 cm | 3.5 mm |

∅6.5-9 mm
with LUER hub

LANDOLT
H-219-08 - H-221-15
15 cm
diam ∅ 3 mm

H-219-08 8 mm / curved
H-220-11 11mm / curved
H-221-15 15mm / curved

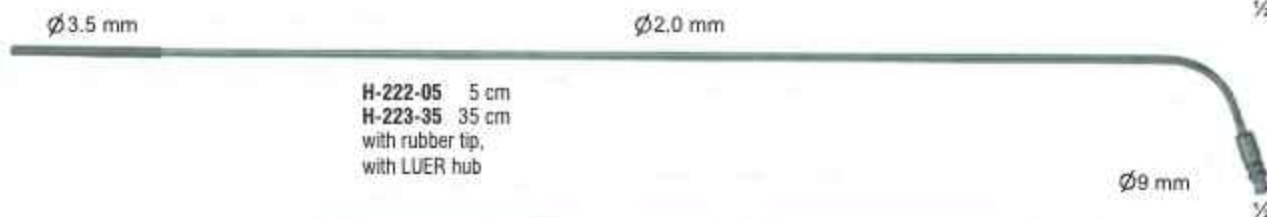

∅3.5 mm

∅2.0 mm

H-222-05 5 cm
H-223-35 35 cm
with rubber tip,
with LUER hub

∅9 mm



H-224-25 2 mm diam
H-225-25 2.5 mm diam
H-226-25 3 mm diam
with finger cut-off,
thumb piece 90° to
curved, with LUER hub
25 cm

∅6-9 mm

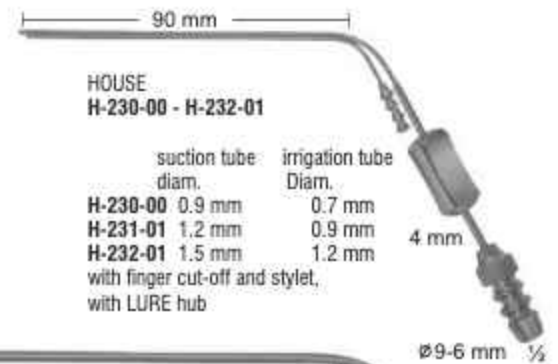
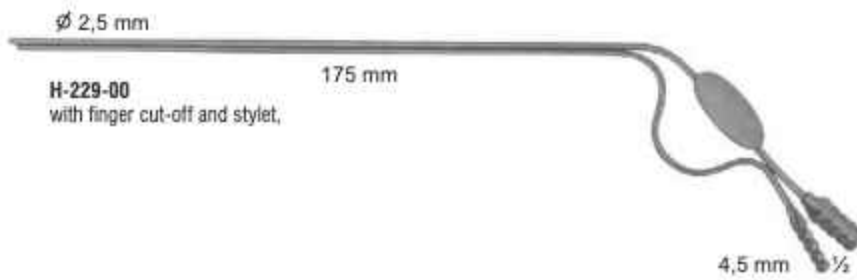

**SECTION
H**

Retractors For Cervical Vertebral Column



1/2

WULLSTEIN
H-235-04 - H-237-4
14 cm
handle with tube, only



WULLSTEIN
H-235-04
4.5 cm
Micro Suction Cannula
Complete, with handle and 3 tips
∅ 0.4 mm



WULLSTEIN
H-236-04
4.5 cm
Micro Suction Cannula
Complete, with handle and 3 tips
∅ 0.6 mm



WULLSTEIN
H-237-04
4.5 cm
Micro Suction Cannula
Complete, with handle and 3 tips
∅ 0.8 mm

⊙

H-238-01
working length 75 mm
∅ 1 mm

⊙

H-239-01
working length 75 mm
∅ 1.5 mm

⊙

H-240-02
working length 75 mm
∅ 2 mm



1/2

BARON-SCHUKNECHT
H-238-01 - H-240-02
with finer cut-off



1/2

ZOELLNER
H-241-00 - H-244-01
Suction Cannula

Suction Tip

- H-241-00 ∅ 0.5 mm
- H-242-00 ∅ 0.7 mm
- H-243-00 ∅ 0.9 mm
- H-244-01 ∅ 1.2 mm



LUER
H-245-16 - H-247-18
Conical

1/2



H-245-16
16.5 cm
∅ 3 mm
working length
110 mm

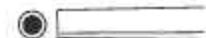

H-246-16
16.5 cm
∅ 3.5 mm
working length
110 mm



H-247-18
18 cm
∅ 4.5 mm
working length
130 mm



YASARGIL
H-248-17 - H-251-17
working length
15 cm

1/2



H-248-17
17 cm
∅ 1.5 mm



H-249-17
17 cm
∅ 2 mm



H-250-17
17 cm
∅ 2.5 mm



H-251-17
17 cm
∅ 3.5 mm



BENELUX
s u r g i c a l

Page 197-223

SECTION

I

- Needle Holders
- Suture Instruments - Reverdin Needles and Ligature Needles
- Guiding Probes
- Micro Needle Holders With Round Handles
- Ligature Needles
- Clip Applying Forceps - Suture Set
- Needle Holders With Tungsten Carbide Inserts
- Cervical Biopsy and Specimen Forceps



CONVERSE
I-100-12
12.5 cm



WEBSTER
I-101-12
12.5 cm



HALSEY
I-102-13
13 cm



DERF
I-103-13
13 cm



HEGAR-BAUMGARTNER
I-104-14
14.5 cm



CRILE-WOOD
I-105-15
15 cm





15 cm



1/2

86
CRILE-WOOD
I-107-16
16 cm

1/2

KILNER
I-108-13
13.5 cm

1/2

ADSON
I-109-17
17.5 cm



MAYO-HEGAR
Medium fine patterns
I-110-15 - I-112-20
I-110-15 15 cm
I-111-18 18 cm
I-112-20 20 cm



HEGAR
Heavy Patterns
I-113-15 - I-116-20
I-113-15 15 cm
I-114-17 17.5 cm
I-115-20 20 cm
I-116-20 20.5 cm



HEANEY (HEGAR)
I-117-20
20 cm



JAMESON
I-118-23
23 cm



WANGENSTEEN
I-119-27
27.5 cm



MASSON
I-120-26
26.5 cm

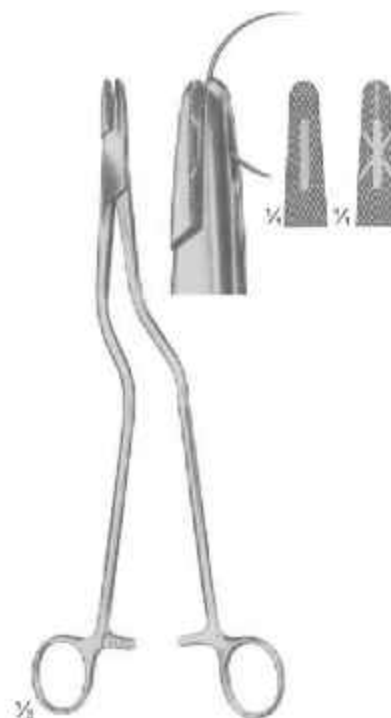

MASSON-LUETHY
I-121-25
25.5 cm



HEGAR-OLSEN
I-122-14 - I-123-18
I-122-14 14 cm
I-123-18 18.5 cm



GILLIES
I-124-15
15 cm



GILLIES
I-125-16
16 cm



EISELSBERG
I-126-11
11.5 cm

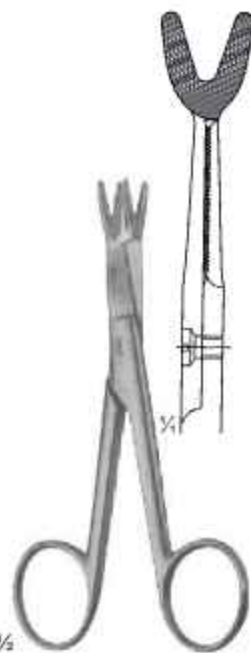

SCHOEMAKER-LOTH
I-127-12
12.5 cm



CRILE
I-128-15
15 cm



TOENNIS
Elastic pattern for
dura- or intestinal suture
I-129-18
18 cm





MATHIEU
I-130-14 - I-132-20
I-130-14 14 cm
I-131-17 17 cm
I-132-20 20 cm



MATHIEU-STILLÉ
Very heavy models
I-133-17 - I-134-20
I-133-17 17.5 cm
I-134-20 20 cm



BOYNTON
I-135-12
12.5 cm



EISELSBERG-MATHIEU
I-136-19
For palate suture
19.5 cm



MATHIEU-KOCHER
I-137-00



BOYNTON
I-138-12
12.5 cm



MILLIN
I-139-24
Ligature holding forceps
24.5 cm

SECTION

I

Suture Instruments - Reverdin Needles



BENELUX
surgical

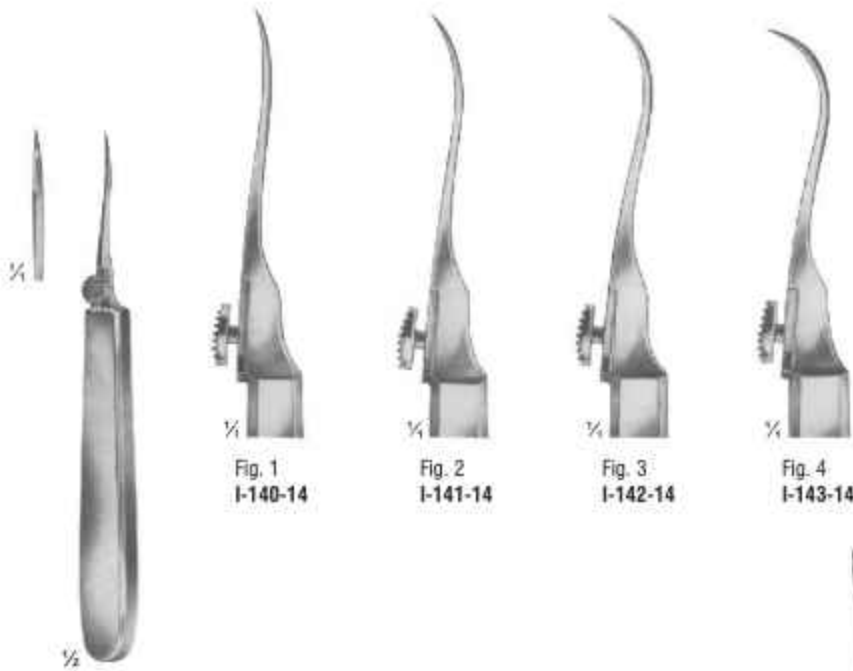

Fig. 1
I-140-14

Fig. 2
I-141-14

Fig. 3
I-142-14

Fig. 4
I-143-14

REVERDIN
I-140-14 - I-143-14
14 cm



Fig. 1
I-144-19

Fig. 2
I-145-19

Fig. 3
I-146-19

Fig. 4
I-147-19

Fig. 1
I-148-22

Fig. 2
I-149-22

Fig. 3
I-150-22

Fig. 4
I-151-22

REVERDIN
I-144-19 - I-147-19
19.5 cm

REVERDIN
I-148-22 - I-151-22
22.5 cm

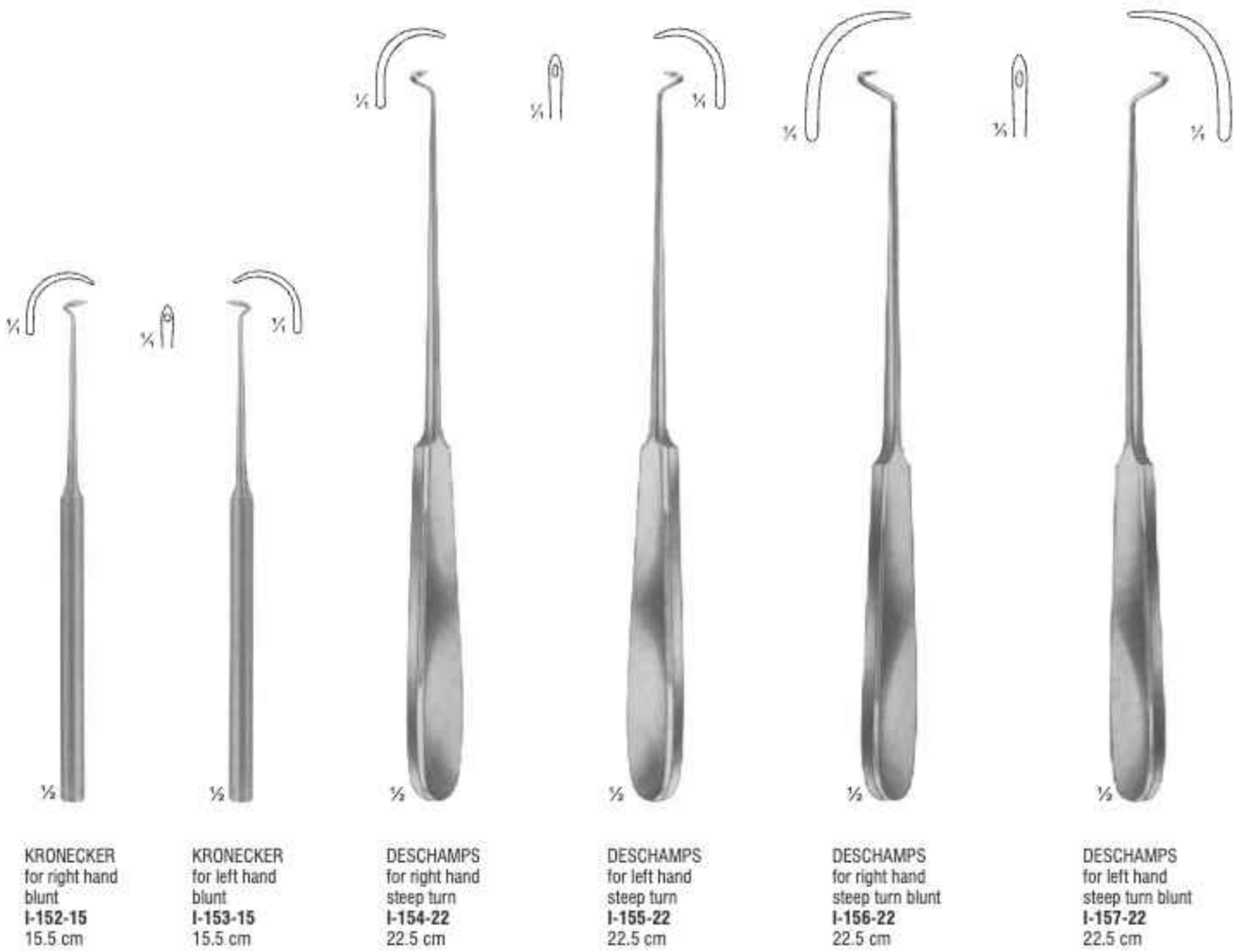



DESCHAMPS
for right hand
steep turn blunt
I-158-23
23 cm

DESCHAMPS
for left hand
steep turn blunt
I-159-23
23 cm



DESCHAMPS
for right hand blunt
I-160-21
21.5 cm

DESCHAMPS
for left hand blunt
I-161-21
21.5 cm

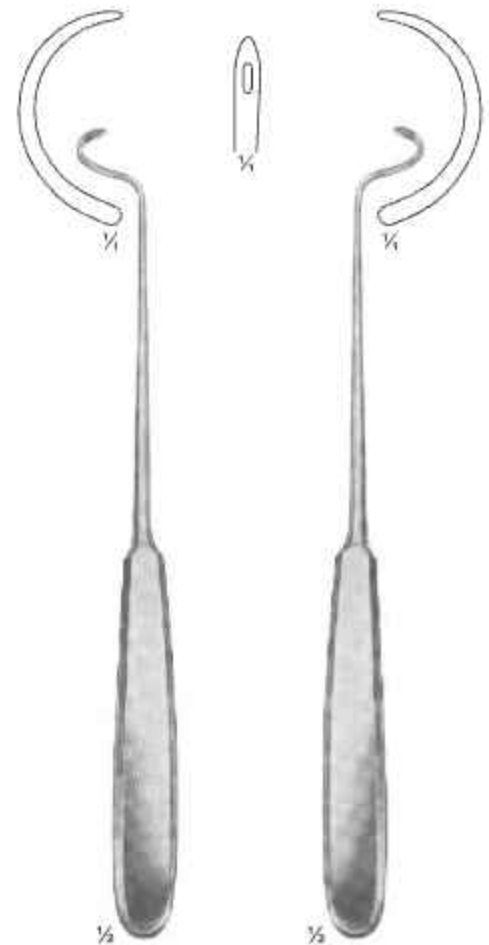

DESCHAMPS
for right hand blunt
I-162-21
21.5 cm

DESCHAMPS
for left hand blunt
I-163-21
21.5 cm

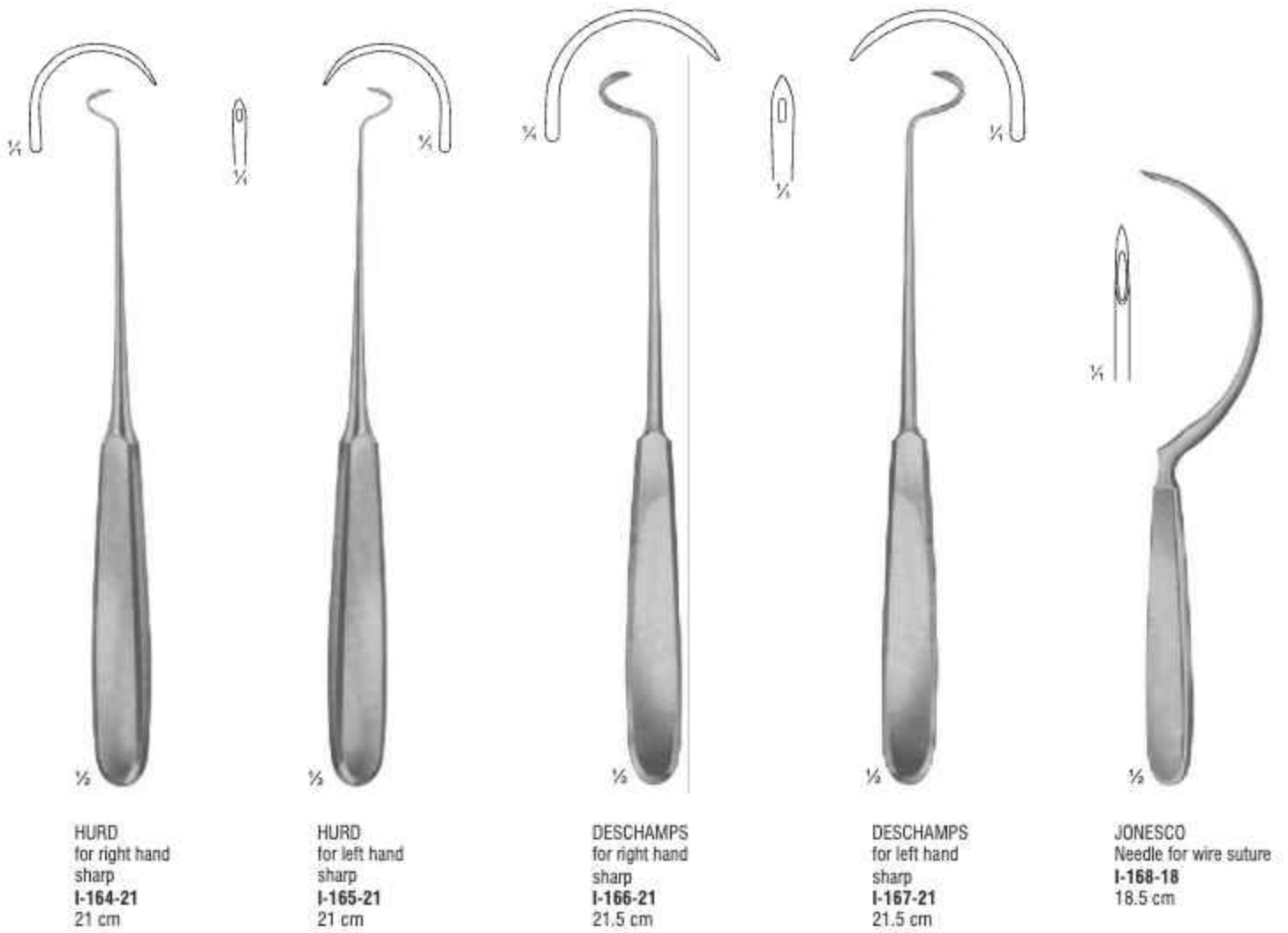



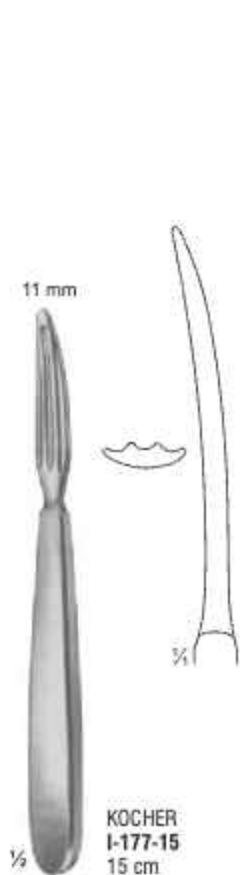



I-181-28
28 cm



KIRSCHNER
I-182-25
25.5 cm



BRUNNER
I-183-24
24.5 cm



Ligature Adjuster
I-184-23
23 cm



CASPER
Ligature Adjuster
I-185-23
23 cm



WIENER MODEL
Suture hook
I-186-23
23.5 cm

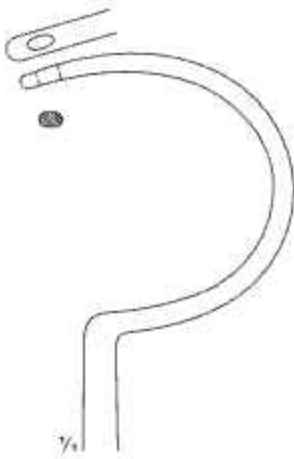

DEMEL
Wire guides
I-187-27 - I-189-30
I-187-27 27.5 cm
I-188-28 28.5 cm
I-189-30 30.5 cm



I-190-22
22.5 cm

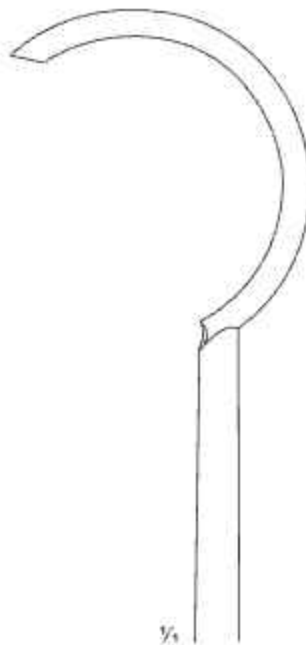

I-191-24 - I-192-27
I-191-24 24 cm
I-192-27 27 cm

SECTION
I

Micro Needle Holders With Round Handles



Straight

YASARGIL
I-193-20
20 cm



$\frac{1}{4}$
Curved

YASARGIL
I-194-20
20 cm



YASARGIL
I-195-22
22.5 cm



YASARGIL
I-196-22
22.5 cm



$\frac{1}{4}$

YASARGIL
I-197-24
24.5 cm

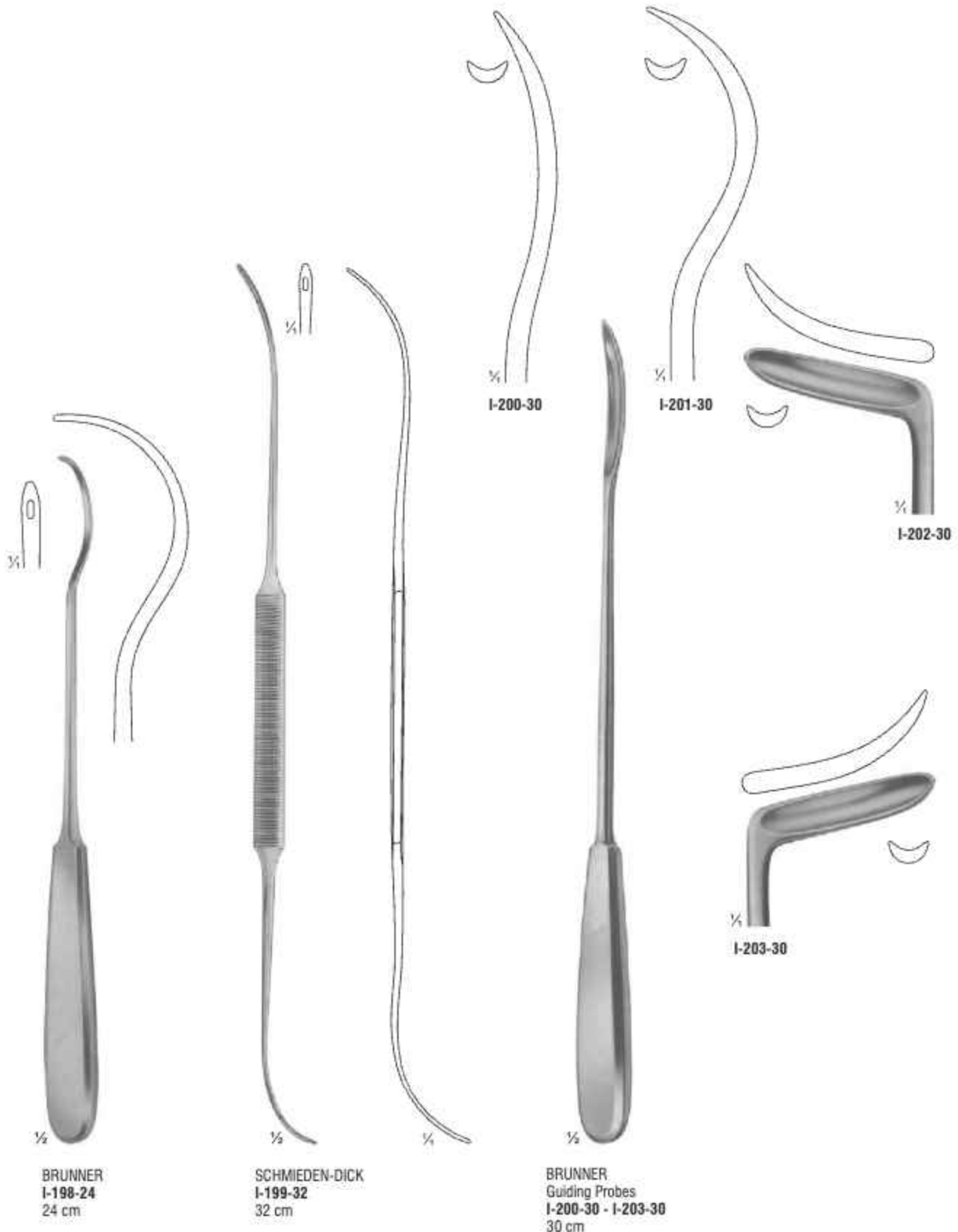



MICHEL
I-204-12
12.5 cm



HEGENBARTH
I-205-12
12 cm



WACHENFELDT
I-206-12
12 cm



WACHENFELDT
I-207-12
12 cm



MICHEL
I-208-12
12.5 cm



MICHEL modif.
I-209-13
13 cm



HEATH
I-210-13
13.5 cm



COLLIN
I-211-13
13.5 cm

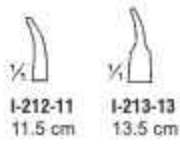

I-212-11 - I-213-13
BARRAQUER
Without catch

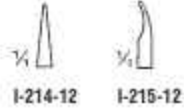

BARRAQUER
Without catch
I-214-12 - I-215-12
12 cm

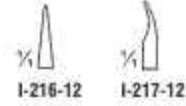

BARRAQUER
With catch
I-216-12 - I-217-12
12 cm



BARRAQUER
With Catch
I-218-15
15 cm

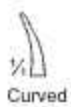

BARRAQUER
With Catch
I-219-15
15 cm



MULLER
With Locking
Mechanism
I-220-14
14.5 cm



BROCK
Without catch
I-221-15
15 cm



BROCK
Without catch
I-222-15
15 cm

SECTION

I

Needle Holders With Tungsten Carbide Inserts TC



BENELUX
surgical

TC GOLD



KALT
I-223-13
13.5 cm



DIETRICH
I-224-16 - I-228-26
I-224-16 16 cm
I-225-18 18 cm
I-226-20 20 cm
I-227-23 23 cm
I-228-26 26 cm



WEBSTER
I-229-13
13 cm



DERF
I-230-12
12 cm



I-231-12
12.5 cm



I-232-14
14 cm

HEGAR-BAUMGARTNER
I-231-12 - I-232-14
I-231-12 12.5 cm
I-232-14 14 cm



WEBSTER
I-233-13
13 cm



I-234-13



I-235-13

HALSEY
I-234-13 - I-235-13
13 cm



CRILE-WOOD
I-236-15 - I-237-18
I-236-15 15 cm
I-237-18 18 cm



SAROT
I-238-18 - I-240-26
I-238-18 18 cm
I-239-20 20 cm
I-240-26 26 cm

SECTION

I

Needle Holders With Tungsten Carbide Inserts TC



BENELUX
surgical

TC GOLD



MAYO-HEGAR
I-241-16 - I-246-30
I-241-16 16 cm
I-242-18 18 cm
I-243-20 20 cm
I-244-24 24 cm
I-245-26 26 cm
I-246-30 30 cm



MAYO-HEGAR (HEANEY)
I-247-20 - I-249-26
I-247-20 20 cm
I-248-24 24 cm
I-249-26 26 cm



DE BAKAY
I-250-18 - I-255-37
I-250-18 18 cm
I-251-20 20 cm
I-252-23 23 cm
I-253-26 26 cm
I-254-31 31 cm
I-255-37 37 cm



RYDER-VASCULAR
I-256-13 - I-261-26
I-256-13 13 cm
I-257-15 15 cm
I-258-18 18 cm
I-259-20 20 cm
I-260-23 23 cm
I-261-26 26 cm



RYDER
I-262-13 - I-267-26
I-262-13 13 cm
I-263-15 15 cm
I-264-18 18 cm
I-265-20 20 cm
I-266-23 23 cm
I-267-26 26 cm



SCHWEDISCHES MODELL
I-268-15 - I-270-20
I-268-15 15 cm
I-269-17 17 cm
I-270-20 20 cm



MAYO-HEGAR (HEANEY)
I-271-14 - I-274-23
I-271-14 14 cm
I-272-18 18 cm
I-273-20 20 cm
I-274-23 23 cm



FINOCCHIETTO
I-275-27
27 cm



MASSON
I-276-27
27 cm



WANGENSTEEN
I-277-27
27 cm

SECTION

I

Needle Holders With Tungsten Carbide Inserts TC



BENELUX
surgical

TC GOLD



BOZEMANN
I-278-20 - I-280-26
I-278-20 20 cm
I-279-24 24 cm
I-280-26 26 cm



BARRY STERNAL
I-281-15 - I-282-20



I-281-15
FOR STERNUM
SUTURE
15 cm

I-282-20
WIRE TWISTER
20 cm



HEGAR
I-283-20 - I-284-24
I-283-20 20 cm
I-284-24 24 cm





STRATTE
I-285-22 - I-286-23
I-285-22 22 cm
I-286-23 23 cm



GILLIES
I-287-16
16 cm



OLSEN-HEGAR
I-288-14 - I-290-18
I-288-14 14 cm
I-289-17 17 cm
I-290-18 18 cm



TOENNIS
I-291-18
18 cm

SECTION

I

Needle Holders With Tungsten Carbide Inserts TC



BENELUX
surgical

TC GOLD



LICHTENBERG
I-292-17 - I-293-20
I-292-17 17 cm
I-293-20 20 cm



MATHIEU-KOCHER
I-294-14 - I-296-20
I-294-14 14 cm
I-295-17 17 cm
I-296-20 20 cm



MATHIEU
I-297-14 - I-299-20
I-297-14 14 cm
I-298-17 17 cm
I-299-20 20 cm



MATHIEU
I-300-14 - I-302-20
I-300-14 14 cm
I-301-17 17 cm
I-302-20 20 cm



ZWEIFEL
I-303-20 - I-304-23
I-303-20 20 cm
I-304-23 23 cm



LANGENBECK
I-305-18 - I-307-23
I-305-18 18 cm
I-306-20 20 cm
I-307-23 23 cm



CASTROVIEJO
I-308-14 - I-311-14
14.5 cm

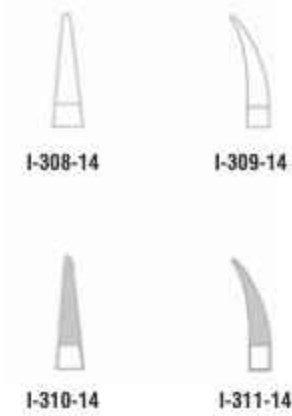

CASTROVIEJO
I-312-18 - I-315-18
18 cm

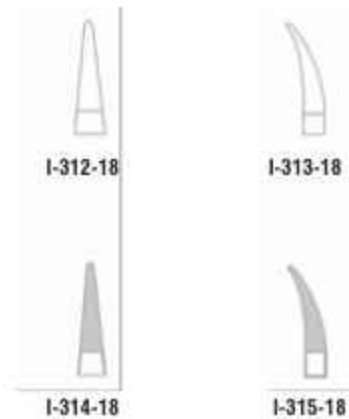



TC GOLD



BARRAQUER
I-316-14 - I-319-14
14.5 cm

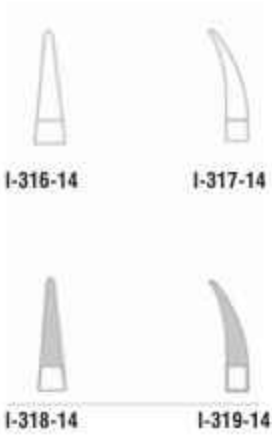

I-316-14

I-317-14

I-318-14

I-319-14



HEPPY SCHEIDEL
I-320-18
18 cm



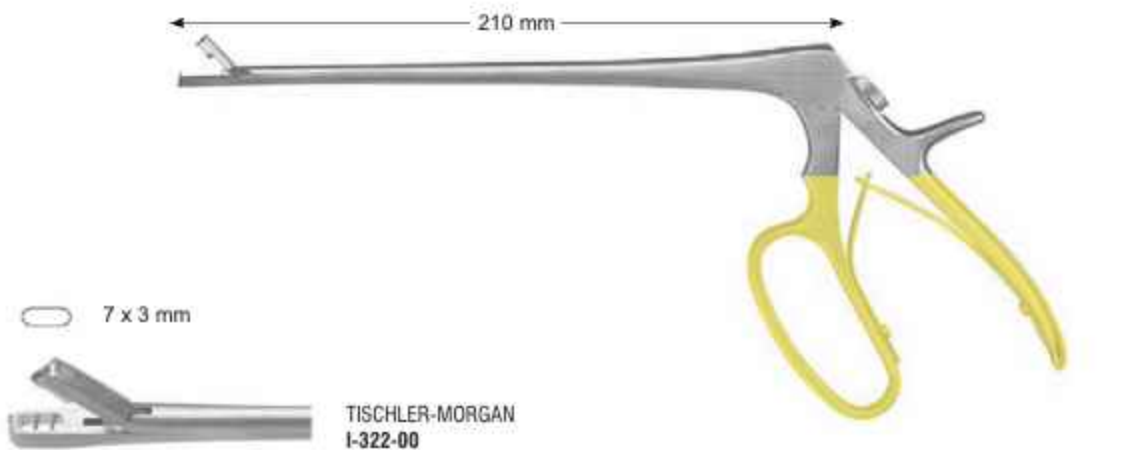
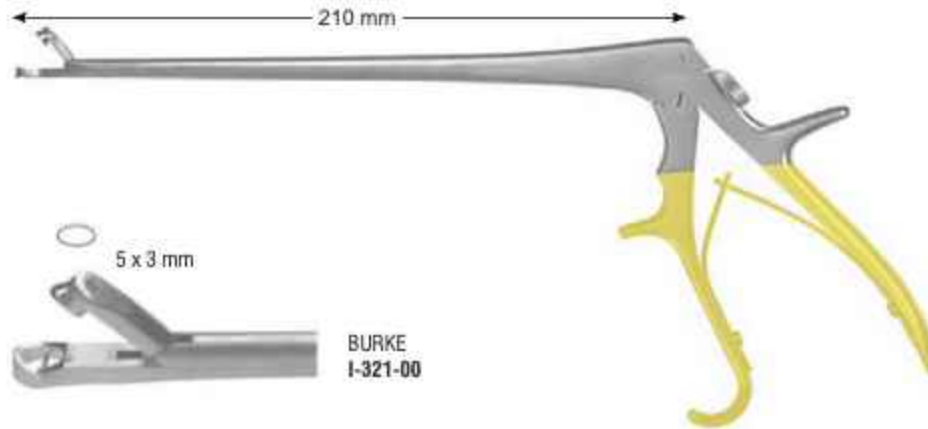



BENELUX
s u r g i c a l

www.beneluxsurgical.com

Tel: +92 52 325 0840

Cell: +92 300 856 5840

Whatsapp: +923008565840

E-mail: info@beneluxsurgical.com, marketing@beneluxsurgical.com

Address: Shatab Garah.Sialkot,Punjab,51310 Pakistan.